

**FLEXIBLE MECHANICAL CABLES CATALOGUE**



Catalogo Comandi Meccanici Flessibili  
Catalogue Cables Mecaniques Flexibles  
Flexible mechanische Kabel Katalog  
Catálogo Cables Mecánicos Flexibles  
Catálogo Cabos Mecânicos Flexíveis



P  
M  
AUTOMOTIVE  
PRODUCTS

VÉHICULE COMMERCIAL TRUCK  
VEHÍCULO CAMIÓN VINTAGE CAR  
D'EPOCA CAMION VÉHICULE COMMERCIAL  
AUTO COMMERCIAL VEHÍCULO CAMION VINTAGE CAR  
COCHE VEICOLO D'EPOCA CAMION VÉHICULE  
COMMERCIAL TRUCK AUTO COMMERCIAL VEHÍCULO  
CAMIÓN VINTAGE CAR COCHE VEICOLO D'EPOCA

Wide range...  
One order...  
One Brand





### **BRAND AUTO PARTS**

PIMAX, from 1979, chooses the most qualified producers putting its own brand.

The quality, seriousness and attention to the customer are the points that Pimax has kept steady and tried to improve over time. Our strenghts are the flexibility and availability to our customers, the wide range of products always proposed quality with a continuous update of models aimed at completing and covering the European, American, South American and Asian circulating fleet and vehicles, vintage cars, commercial vehicles, trucks and agricultural vehicles.

*Wide range... one order... one brand... PIMAX*

Pimax is also present on many portals dedicates to vintage cars such as Superclassics and Postoautodepoca. As well as on the largest business portal in Europe: Europages.



### **BRAND AUTO PARTS**

Depuis 1979 PIMAX choisit les producteurs les plus qualifiés afin d'imposer son propre brand.

La qualité, le sérieux et l'attention apporté aux clients sont les points que Pimax a maintenu et a toujours essayé d'améliorer. Nos points forts sont la flexibilité et la disponibilité envers nos clients ainsi qu'une large gamme de produits ; de toujours proposer des produits de qualité et de constamment mettre à jour notre gamme afin de couvrir tous les modèles circulants en Europe, Amérique, Amérique du Sud et Asie pour tout ce qui concerne le secteur automobile, voitures d'époque, utilitaires, poids-lourds et agricole.

*Large gamme... une commande... une marque... PIMAX*

Pimax est également présent sur de nombreux portails dédiés aux voitures d'époque tels que Superclassics et Postoautodepoca ainsi que sur Europages.



### **AUTORICAMBI FIRMATI**

PIMAX, dal 1979, sceglie i produttori più qualificati apponendo il proprio marchio.

La qualità, serietà ed attenzione al cliente sono i punti che la Pimax ha mantenuto ben saldi e cercato di migliorare nel tempo. I nostri punti di forza sono la flessibilità e disponibilità verso i nostri clienti, l'ampia gamma di prodotti proposti, sempre di qualità, con un continuo aggiornamento di modelli volti a completare e coprire il parco circolante europeo, americano, sudamericano ed asiatico e riguardante veicoli, auto d'epoca, veicoli commerciali, camion e veicoli agricoli.

*Ampia gamma... un solo ordine... un solo marchio ... PIMAX*

Pimax inoltre è presente su molti portali dedicati alle auto d'epoca come Superclassics e Postoautodepoca nonché sul portale per aziende più grande d'europa: Europages.

● [www.pimax.it](http://www.pimax.it) ●



WINDOW REGULATORS



FLEXIBLE MECHANICAL CABLES



BRAKE HOSES

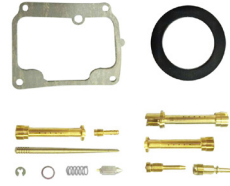

CARBURETOR KITS

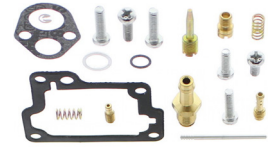

CARBURETOR SPARE PARTS



RUBBER BODY PROFILES



WINDSHIELD REAR WINDOW & REVOLVING WINDOW SEALS



FUEL PUMPS



ENGINE VALVES



THERMOPLASTIC PROFILES



GLOW PLUGS



IGNITION WIRE SET & PENCIL COILS



SOLENOID-VALVES & COMMON RAIL PRESSURE REGULATORS



RADIATOR TANKS, CAPS, WINDSCREEN WATER PUMPS NOZZLES & VARIOUS



DOOR HANDLES & LATCHES

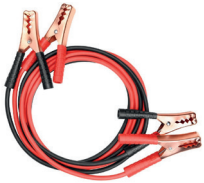

COMPONENTS



CORTECO, SEALS BY DIMENSION



OLSA PARTS LIGHTS AND LIGHTING COMPONENTS



LUCAS OIL



PARKING SENSORS



// Wide range...  
one order...  
one brand... **PIMAX** //

CLASSIC BRAND AUTO PARTS





**automotive products**

## INDICE – INDEX

<b>CAVI FRIZIONE</b> - CLUTCH CABLES - CABLES DE DEBRAYAGE KUPPLUNGSSEILE - CABLE EMBRAGUE - CABOS DE EMBRAIAGEM LINKI SPRZĘGŁA - SPOJKOVÁ LANKA - ТРОСЫ СЦЕПЛЕНИЯ	1-30
<b>COMANDI ARIA CARBURATORE</b> - CHOKE CABLES - TIRETTES DE STARTER STARTERZUGE - CABLES DE CHOQUE - CABOS DE CHOKE LINKI SSANIA - LANKA SYTIČE - ТРОСЫ УПРАВЛЕНИЯ ДРОССЕЛЬНОЙ ЗАСЛОНКОЙ КАРБЮРАТОРА	31-34
<b>COMANDI APERTURA COFANO</b> - CABLES CAPOT - BONNET CABLES HAUBENZUGE - CABLES DE CAPOTA - CABOS DO CAPOT LINKI MECHANIZMU PODNOSZENIA MASKI - LANKA KAPOTY - ТРОСЫ КАПОТА	35-38
<b>COMANDI AVVIAMENTO MOTORINO</b> - CABLES COMPLETS DEMARREUR - COMPLETE STARTER CABLES ANLASSERLEITUNGEN - CABLES DE MOTORILLO - CABOS DE M/ARRANQUE CIĘGNA ROZRUSZNIKA - LANKA STARTÉRU - ПРОВОДА СТАРТЕРА	39
<b>COMANDI ACCELERATORE A PEDALE</b> -ACCELERATOR CABLES (THROTTLE) - CABLES D' ACCELERATEUR VERGASERZUGE - CABLES DE ACELERADOR - CABOS DE ACELERADOR LINKI GAZU - LANKA PEDÁLU PLYNU - ТРОСЫ ГАЗА	40-69
<b>COMANDI FLESSIBILI FUNE FRENO A MANO</b> - BRAKE CABLES - CABLES DE FREIN BREMSSEILE - CABLES DE FRENO - CABOS DE TRAVAO LINKI HAMULCA - BRZDOVÁ LANKA -ТРОСЫ РУЧНОГО ТОРМОЗА	70-146
<b>COMANDI ACCELERATORE A MANO</b> - HAND ACCELERATOR CABLES - TIRETTES DE STARTER VERGASERZUGE - CABLES DE ACCELERADOR DE MANO - CABOS DE ACELERADOR DE MAO RĘCZNE LINKI GAZU - LANKA RUČNÍHO AKCELERÁTORU ТРОСЫ РУЧНОГО УПРАВЛЕНИЯ ДРОССЕЛЬНОЙ ЗАСЛОНКОЙ	147
<b>FUNICELLE ALZACRISTALLO</b> - STEEL CABLES FOR WINDOW - CABLES DE LEVE GLACE CABOS DE ELEVADOR VIDRO - STALOWE LINKI DO MECHANIZMU PODNOSZENIA OKNA OCELOVÁ LANKA PRO OKNO - СТАЛЬНЫЕ ТРОСЫ ДЛЯ СТЕКЛОПОДЪЕМНИКОВ	148
<b>TRASMISSIONI FLESSIBILI CONTACHILOMETRI</b> - SPEEDOMETER CABLES - CABLES DE COMPTEUR TACHOMETERWELLEN - FLEXIBLES VELOCIMETROS - CABOS C/KILOMETROS LINKI SZYBKOŚCIOMIERZA - LANKA RYCHLOMĚRU - ТРОСЫ СПИДОМЕТРА	149-168
<b>TRASMISSIONI CKM INTERNE REGOLABILI</b> - UNIVERSAL INNER SPEEDOMETER CABLES CABLES DE COMPTEUR REGLABLES – FLEXIBLES VELOCIMETRO UNIVERSALES CABOS C/KILOMETROS UNIVERSAIS - CIĘGNA LINEK SZYBKOŚCIOMIERZA UNIVERZÁLNÍ VNITŘNÍ LANKA RYCHLOMĚRU -УНИВЕРСАЛЬНЫЕ ТРОСЫ СПИДОМЕТРА БЕЗ ОБОЛОЧКИ	169







**automotive products**

**CAVI FRIZIONE  
CLUTCH CABLES  
CABLES DE DEBRAYAGE  
KUPPLUNGSSEILE  
CABLES EMBRAGUE  
CABOS DE EMBRAIAGEM  
LINKI SPRZĘGŁA  
SPOJKOVÁ LANKA  
ТРОСЫ СЦЕПЛЕНИЯ**

ARO .....	pag. 1
AUDI .....	pag. 1
CHEVROLET-DAEWOO .....	pag. 1
CHRYSLER .....	pag. 1
CITROEN .....	pag. 1-4
DAIHATSU .....	pag. 4
FERRARI .....	pag. 4
FIAT .....	pag. 5-9
FORD .....	pag. 9-11
HONDA .....	pag. 11-12
HYUNDAI .....	pag. 12
INNOCENTI .....	pag. 12
ISUZU .....	pag. 12
KIA .....	pag. 12
LADA VAZ .....	pag. 12
LANCIA .....	pag. 12-14
MAZDA .....	pag. 14
MERCEDES .....	pag. 14
MITSUBISHI .....	pag. 14
NISSAN .....	pag. 14-15
OPEL .....	pag. 15-17
PEUGEOT .....	pag. 17-20
POLSKI .....	pag. 20-21
PORSCHE .....	pag. 21
RENAULT .....	pag. 21-24
ROVER .....	pag. 24
SAAB .....	pag. 24
SEAT .....	pag. 24-26
SKODA .....	pag. 26
SUBARU .....	pag. 26-27
SUZUKI .....	pag. 27
TALBOT .....	pag. 27
TOYOTA .....	pag. 27-28
VOLKSWAGEN .....	pag. 28-29
VOLVO .....	pag. 29-30
ZASTAVA .....	pag. 30

**CAVI FRIZIONE - CLUTCH CABLES - CABLES DE DEBRAYAGE  
KUPPLUNGSSEILE - CABLES EMBRAGUE - CABOS DE EMBRAIAGEM  
LINKI SPRZĘGŁA - SPOJKOVÁ LANKA - ТРОСЫ СЦЕПЛЕНИЯ**

				<b>OEM REF.</b>	
<b>ARO</b>					
10.1-1,3 (mot. Renault )		320/490	<b>01.077</b>	6001546181	•

<b>AUDI</b>					
50 all	74=>	375/595	<b>01.670</b>	861721335A	0,181
80 all	72=>	655/950	<b>01.567</b>	843721335	0,328
80 GL 1,3-GL-C-CL-LC	10/78=>07/83	805/1115	<b>01.671</b>	321721335C	0,414
80 (4 cyl.) all	79=>83	640/940	<b>01.249</b>	811721335F	0,323
80 (5 cyl.) all	80=>83	600/980	<b>01.602</b>	321721335E	0,413
80 1,6-1,8 all	84=>	590/930	<b>01.731</b>	811721335P	0,270
80 D 1,6	80=>	650/940	<b>01.603</b>	811721335C-811721335H	0,390
80/90 all 1,6 Form. E-1,8-2,0 TD	08/83=>	590/930	<b>01.148</b>	811721335Q-811721335R	0,301
100 GL-LS-Coupé GL1,8-1,9	70=>77	655/830	<b>01.163</b>	803721335A	0,229
100 GL-LS 1,8-1,9ie	77=>	640/900	<b>01.336</b>	803721335B	0,341
100 GL-LS 1,8-1,9ie	79=>	645/880	<b>01.470</b>	803721335C	0,339
100 S-LS-GLS (4 cyl.)	77=>07/82	685/1160	<b>01.335</b>	431721335G	0,361
100 (4 cyl.) all	08/82=>84	660/1190	<b>01.079</b>	443721335C	0,331
100 S-LS-GLS (4 cyl.)	84=>	765/1280	<b>01.143</b>	443721335D	0,426
100 1,9-2,0ie (5 cyl.)	76=>82	650/1220	<b>01.535</b>	431721335F	0,363
100 (5 cyl.)	08/82=>84	650/1190	<b>01.080</b>	443721335B	0,363
100 (5 cyl.) all	84=>	670/1200	<b>01.732</b>	443721335E	0,367
4000 D (USA mod.)	80=>	650/940	<b>01.603</b>	811721335C-811721335H	0,390





<b>CHEVROLET-DAEWOO</b>					
Matiz all	98=>	576/851	<b>01.0612</b>	96315242	0,246
Matiz all (800cc)	05=>	580/845	<b>01.1210</b>	96590791-25187108	0,298
Matiz all (1000cc)	05=>	565/825	<b>01.1237</b>	25187023-96590793	0,303
Aveo all	06=>	685/860	<b>01.1238</b>	96339736	0,305
Spark all	09=>	580/845	<b>01.1210</b>	96590791-25187108	0,298
Kalos all	06=>	685/860	<b>01.1238</b>	96339736	0,305

<b>CHRYSLER</b>					
Voyager	86=>91	600/1050	<b>01.086</b>	4377770	0,268

<b>CITROEN</b>					
2 CV/Dyane/Mehari/Acadyane	70=>	545/705	<b>01.279</b>	AY3142E	0,277
3 CV/Dyane/Mehari/Acadyane	70=>	545/705	<b>01.276</b>	AY3142A-95494917	0,198
Dyane	68=>	380/595	<b>01.003</b>	AY3142	•
Dyane	=>69	385/610	<b>01.278</b>	AY3142D	0,166
Ami 6 (AM2-AMB2)/Ami 8/Break	68=>	480/640	<b>01.282</b>	AM3142K	0,183
Ami Super	03/72=>	600/740	<b>01.486</b>	5425958	0,213

Cavo Frizione Autoregistrante - Selfadjusting Clutch Cables - à rattrapage Automatique - Samostavitelná spojková lanka - Саморегулируемые тросы сцепления  
Cavo Frizione Registrazione Manuale - Manual Adjusting Clutch Cable - à réglage manuel - Spojkové lanko staviteľné ručne - Тросы сцепления ручного регулирования

**CAVI FRIZIONE - CLUTCH CABLES - CABLES DE DEBRAYAGE  
KUPPLUNGSSEILE - CABLES EMBRAGUE - CABOS DE EMBRAIAGEM  
LINKI SPRZĘGŁA - SPOJKOVÁ LANKA - ТРОСЫ СЦЕПЛЕНИЯ**

				OEM REF.	
<b>CITROEN</b>					
LN-LNA	78=>	600/780	<b>01.488</b>	5490829	0,205
LNA 11E-11RE (1124cc)	05/81=>	275/470	<b>01.145</b>	95495608	0,155
Visa Club/Visa Special (652 cc)	=>05/80	655/835	<b>01.463</b>	75492029-95493247	0,217
Visa Club/Visa Special (652 cc)	06/80=>	640/830	<b>01.490</b>	95493315	0,211
Visa-Super E/L (1124cc)	=>05/80	290/435	<b>01.462</b>	75491651-95493403	0,103
Visa-Super E/LX/GT (1124cc)	06/80=>	245/440	<b>01.489</b>	95493316-95545123	0,137
Visa GTI/D	84=>	580/795	<b>01.144</b>	95496584-95594985	0,248
Axel all	85=>	550/745	<b>01.133</b>	95492653-95609631	0,228
AX all	86=>	505/665	<b>01.131</b>	95598955	0,209
AX all	88=>	470/630	<b>01.274</b>	96046150	0,225
AX all (exc.1,4)	07/91=>	400/635	<b>01.088</b>	96101674-96226727-96156046 2150N0	0,260
AX 1,4ie	07/91=>	440/685	<b>01.089</b>	96089335	0,274
Saxo all (exc.D)	02/96=>	430/675	<b>01.0019</b>	2150Q2-96262085	0,307
Saxo D	02/96=>	510/670	<b>01.0180</b>	2150Q3-96259810	0,446
GS/GSA all	74=>	1020/1180	<b>01.284</b>	GX4217601A-5455721	0,336
ZX 1,1-1,4	91=>	371/610	<b>01.090</b>	96104679	0,208
ZX 1,1-1,4 (ch. 6568-)	94=>	375/640	<b>01.0237</b>	2150K7-2150N9	0,219
ZX 1,6-1,9 (-ch. 6567)	91=>	375/660	<b>01.091</b>	96104680	0,235
ZX 1,6-1,8-2,0 (ch. 6568-)	94=>	360/665	<b>01.0238</b>	2150K6-2150N8	0,236
ZX 2,0 16v-1,9 TD (-ch. 6567)	93=>	545/710	<b>01.087</b>	96110296-2150R5	0,450
ZX 16v-1,9 D-TD (ch. 6568-)	94=>	550/745	<b>01.0239</b>	2150K8-2150P0	0,583
ZX 1,9 D (ch. 6749-)	96=>	365/690	<b>01.0181</b>	2150P8	0,178
ZX 2,0 16v-1,9 TD (ch. 6810-)	97=>	562/757	<b>01.0324</b>	2150Q0	0,294
C1 1,0 all	05=>	1400/1564	<b>01.1123</b>	2150CQ	0,527
C1 1,4 D all	05=>	1285/1450	<b>01.1124</b>	2150CR	0,478
Xsara all 1,4-1,6 (manual adjust)	97=>	334/625	<b>01.0321</b>	2150V7-9625275680	0,236
Xsara all 1,4-1,6 (a/a)	97=>	353/615	<b>01.1137</b>	2150V7-9625275680	0,368
Xsara all 1,8i-1,9 D (manual adjust)	97=>	314/667	<b>01.1093</b>	2150V9-9625276780	0,508
Xsara 1,8-1,9 D all (a/a)	97=>	314/667	<b>01.1100</b>	2150V9-9625276780	1,573
Xsara all 2,0-1,9TD (manual adjust)	97=>	513/732	<b>01.0323</b>	2150V2-9632112980	0,514
Xsara 2,0-1,9 TD (a/a)	97=>00	518/717	<b>01.1136</b>	2150V2-9632112980	0,607
Xsara 1,6-1,8-2,0 16v-1,9 D-2,0 Hdi (manual adjust)	00=>	688/933	<b>01.0608</b>	2150Z6-2150AR-9646122580	0,505
Xsara Picasso 1,6-1,8-2,0 16v-1,9 D (a/a)	00=>	688/933	<b>01.1101</b>	2150Z6-2150AR-9646122580	0,608
Xsara Picasso 1,6-1,8-2,0 16v-2,0Hdi (a/a)	00=>	715/905	<b>01.1102</b>	2150AT-2150AS-2150Z5 9645688880	0,917
Xsara Picasso 1,6-1,8-2,0 16v-2,0Hdi (manual adjust)	00=>	695/895	<b>01.1134</b>	2150AT-2150AS-2150Z5	0,790
BX 14 all (-ch. 4192)	82=>	280/460	<b>01.547</b>	95496081-95496745-95610155	0,328
BX all 16-D	82=>	480/680	<b>01.548</b>	95496082-95496746	0,378
BX Sport-16-19-D	86=>	480/680	<b>01.305</b>	95610218	0,391

Cavo Frizione Autoregistrante - Selfadjusting Clutch Cables - à rattrapage Automatique - Samostavitelná spojková lanka - Саморегулируемые тросы сцепления  
Cavo Frizione Registrazione Manuale - Manual Adjusting Clutch Cable - à réglage manuel - Spojkové lanko staviteľné ručné - Тросы сцепления ручного регулирования

**CAVI FRIZIONE - CLUTCH CABLES - CABLES DE DEBRAYAGE  
KUPPLUNGSSEILE - CABLES EMBRAGUE - CABOS DE EMBRAIAGEM  
LINKI SPRZĘGŁA - SPOJKOVÁ LANKA - ТРОСЫ СЦЕПЛЕНИЯ**

				<b>OEM REF.</b>	
---	---	---	--	-----------------	---

**CITROEN**

BX all TD	88=>	390/700	<b>01.093</b>	95636691	0,467
BX 11 all (ch. 4193-)	90=>	1000/1230	<b>01.092</b>	96044602	0,381
BX 14 all (ch. 4193-)	90=>	1000/1230	<b>01.092</b>	96044602	0,381
Xantia all (exc.16v)	93=>	470/780	<b>01.083</b>	96097749	0,235
Xantia all 16v-TD (-ch. 6747)	93=>	650/850	<b>01.096</b>	96108987	0,510
Xantia all 16v-TD (ch. 6748-)	96=>	645/840	<b>01.0182</b>	2150P5	0,027
Xantia 1,9 D (exc.T) (ch. 6748-)	97=>	470/780	<b>01.0327</b>	2150P4	0,538
CX 2,0	=>10/74	490/860	<b>01.285</b>	5452431	0,165
CX (4 speed) all	74=>82	470/875	<b>01.286</b>	5490093	0,179
CX (4 speed) all	83=>	630/820	<b>01.599</b>	95495593	0,497
CX (4 speed) all	07/85=>	625/875	<b>01.277</b>	95606505	0,440
CX (5 speed) all	=>82	610/870	<b>01.487</b>	75491605	0,509
CX (5 speed) all	83=>	475/875	<b>01.136</b>	95492896	0,505







**CITROEN - Commercial Vehicle**

Evasion 2,0 BV BE3-BE3R (a/a)	95=>	410/765	<b>01.1103</b>	2150S4-1476637080-1479128080	0,576
Evasion 2,0 (manual adjust)	95=>	360/760	<b>01.0078</b>	2150S4-1476637080-1479128080	0,536
Evasion 2,0TB-1,9 TD (a/a)	95=>	550/855	<b>01.1104</b>	2150T1-1480346080-1476638080	0,661
Evasion 2,0TB-1,9 TD (manual adjust)	95=>	515/855	<b>01.0079</b>	2150T1-1480346080-1476638080	0,555
Evasion 2,1 TD (a/a)	96=>	765/1085	<b>01.1105</b>	2150P6-1476128080	0,472
Evasion 2,1 TD (manual adjust)	96=>	750/1095	<b>01.0356</b>	2150P6-1476128080	0,405
Evasion 1,9 D-2,0 BE4R (a/a)	00=>	685/965	<b>01.1118</b>	2150AC-1487268080	0,556
Evasion 1,9 D-2,0 BE4R (manual adjust)	00=>	655/965	<b>01.1146</b>	2150AC	0,488
Evasion 2,0 Hdi (a/a)	00=>	695/995	<b>01.1119</b>	2150AN-1487725080	0,549
Evasion 2,0 Hdi BV/ML5C (manual adjust)	00=>	660/1000	<b>01.1147</b>	2150AN	0,494
Furgonette 2CV (AKS 400 Kg)	70=>	545/705	<b>01.276</b>	AY3142A-95494917	0,198
Berlingo all 1,4-1,6 (exc.1,8 D) (manual adjust)	97=>	340/635	<b>01.0325</b>	2150R1	0,264
Berlingo all 1,4-1,6 (exc.1,8 D) (a/a)	97=>	340/635	<b>01.1138</b>	2150R1	0,333
Berlingo all 1,8 (manual adjust)	97=>	310/660	<b>01.0326</b>	2150V1	0,263
Berlingo all 1,8 (a/a)	97=>	310/650	<b>01.1085</b>	2150V1	0,365
Berlingo all 1,6 16v (a/a)	98=>	724/902	<b>01.0611</b>	2150AH-96384246802	0,527
Berlingo all 1,6 16v (manual adjust)	98=>	700/895	<b>01.1135</b>	2150AH-96384246802	0,502
Berlingo II 1,6 HDi PF-1,9 D- 2,0 HDi Multispace (ch. 11190-) (manual adjust)	11/02=>	660/870	<b>01.1148</b>	2150CY-9664708080	•
Berlingo II 1,6 HDi PF-1,9 D- 2,0 HDi Combi Cab (ch. 11190-) (manual adjust)	11/02=>	660/870	<b>01.1148</b>	2150CY-9664708080	•
Berlingo all gear BE4R (manual adjust)	03=>	700/895	<b>01.1139</b>	2150CF	0,500
Berlingo all gear BE4R (a/a)	03=>	724/902	<b>01.1083</b>	2150CF-9648780380	0,559
Berlingo D all (a/a)	97=>	366/653	<b>01.0651</b>	2150R2	0,634
Berlingo D all (manual adjust)	97=>	375/655	<b>01.1084</b>	2150R2	0,529
Berlingo all gear BE4R (a/a)	07=>	705/870	<b>01.1183</b>	2150CY-9664708080	0,578

Cavo Frizione Autoregistrante - Selfadjusting Clutch Cables - à rattrapage Automatique - Samostavitelná spojková lanka - Саморегулируемые тросы сцепления  
Cavo Frizione Registrazione Manuale - Manual Adjusting Clutch Cable - à réglage manuel - Spojkové lanko stavitelné ručně - Тросы сцепления ручного регулирования

**CAVI FRIZIONE - CLUTCH CABLES - CABLES DE DEBRAYAGE  
KUPPLUNGSSEILE - CABLES EMBRAGUE - CABOS DE EMBRAIAGEM  
LINKI SPRZĘGŁA - SPOJKOVÁ LANKA - ТРОСЫ СЦЕПЛЕНИЯ**





				OEM REF.	
<b>CITROEN - Commercial Vehicle</b>					
Berlingo all gear BE4R (manual adjust)	07=>	660/870	<b>01.1148</b>	2150CY-9664708080	•
Jumpy 2,0 BV BE3-BE3R (a/a)	95=>	410/765	<b>01.1103</b>	2150S4-1476637080-1479128080	0,576
Jumpy 2,0 (manual adjust)	95=>	360/760	<b>01.0078</b>	2150S4-1476637080	0,536
Jumpy 2,0 TB-1,9 TD (a/a)	95=>	550/855	<b>01.1104</b>	2150T1-1476638080	0,661
Jumpy 2,0 TB-1,9 TD (manual adjust)	95=>	515/855	<b>01.0079</b>	2150T1-1480346080-1476638080	0,555
Jumpy 2,1 TD (a/a)	96=>	765/1085	<b>01.1105</b>	2150P6-1476128080	0,472
Jumpy 2,1 TD (manual adjust)	96=>	750/1095	<b>01.0356</b>	2150P6-1476128080	0,405
Jumpy 1,9 D-2,0 BE4R (a/a)	00=>	685/965	<b>01.1118</b>	2150AC-1487268080	0,556
Jumpy 1,9 D-2,0 BE4R (manual adjust)	00=>	655/965	<b>01.1146</b>	2150AC	0,488
Jumpy 2,0 Hdi (a/a)	00=>	695/995	<b>01.1119</b>	2150AN-1487725080	0,549
Jumpy 2,0 Hdi BV/ML5C (manual adjust)	00=>	660/1000	<b>01.1147</b>	2150AN	0,494
C15 BZ (-ch. 4195)	85=>	245/440	<b>01.489</b>	95493316-95545123	0,137
C15 D (ch. 4496-) (1769cc)	07/87=>	380/690	<b>01.094</b>	95636991	0,217
C15 BZ (ch. 4196-) (954cc-1124cc-1360cc)	88=>	440/670	<b>01.999</b>	95636976	0,228
C15 D (-ch. 4495) (1769cc)	85=>	580/795	<b>01.144</b>	95496584-95594985	0,248
C25 all	83=>	920/1190	<b>01.451</b>	ZF04460471-2150E2	0,355
C35 all	77=>	1925/2120	<b>01.241</b>	ZF05437678	0,709
Jumper BV ME5T 2,0-D 1,9	94=>	540/1035	<b>01.0282</b>	2150J2-2150T4-2150T5 1310131080	0,289
Jumper BV ME5T 1,9 TD	94=>	555/1090	<b>01.0284</b>	2150J4-2150T6-1312633080 1318446080	0,540
Jumper BV MG5T 2,0-D-TD-3,5T	94=>	650/1080	<b>01.0283</b>	2150J3-2150T7-1310132080	0,429
Jumper D 2,8	03=>	925/1480	<b>01.0372</b>	2150AP-1335053080	0,730
Jumper D 2,8	03=>	910/1438	<b>01.0618</b>	2150AV-1335052080	0,431

<b>DAIHATSU</b>					
Applause A101-111 1,6	88=>	582/695	<b>01.1239</b>	3134087108000-721000	0,322
Charade (3 cyl.) G11-G30-G21	84=>87	510/715	<b>01.0289</b>	3134087713000	0,252
Charade (3 cyl.) G100-G101	88=>90	620/725	<b>01.0290</b>	3134087716000-29000	0,322
Charade (3 cyl.) G100 w/Efi (exc.T)	88=>	620/745	<b>01.0291</b>	3134087717000	0,335
Charade (4 cyl.)	89=>11/90	582/695	<b>01.1239</b>	3134087108000-3134087109000 3134087721000	0,322
Charmant 1,3	82=>88	750/1715	<b>01.0292</b>	3134019225000	0,391
Rocky 4WD	90=>92	2030/2235	<b>01.0294</b>	3134087625000	0,673

<b>FERRARI</b>					
308 GTB-GTS			<b>01.1240</b>	106745	•
308 GT4			<b>01.1241</b>	106598	•
308 GTB			<b>01.1242</b>	500748	•
					•
101			<b>01.1243</b>	110020	•





Cavo Frizione Autoregistrante - Selfadjusting Clutch Cables - à rattrapage Automatique - Samostavitelná spojková lanka - Саморегулируемые тросы сцепления  
Cavo Frizione Regolazione Manuale - Manual Adjusting Clutch Cable - à réglage manuel - Spojkové lanko staviteľné ručné - Тросы сцепления ручного регулирования

**CAVI FRIZIONE - CLUTCH CABLES - CABLES DE DEBRAYAGE  
KUPPLUNGSSEILE - CABLES EMBRAGUE - CABOS DE EMBRAIAGEM  
LINKI SPRZĘGŁA - SPOJKOVÁ LANKA - ТРОСЫ СЦЕПЛЕНИЯ**

				OEM REF.	
<b>FIAT</b>					
N 500 D	=>64	330/2100	<b>01.100</b>	980504	0,221
500 F-L (I° s.)	=>72	330/2100	<b>01.101</b>	4117460-4178169	0,233
500 L (II° s.)	72=>	330/2070	<b>01.102</b>	4285285	0,237
500 R	73=>	330/2060	<b>01.103</b>	4285573	0,205
126-126 Personal-126 Bis	73=>	330/2060	<b>01.103</b>	4285573	0,205
Cinquecento 700cc	92=>	400/680	<b>01.017</b>	7632289	0,196
Cinquecento 900cc	92=>	300/590	<b>01.018</b>	7680262	0,173
Cinquecento Sporting	94=>	400/780	<b>01.0183</b>	46406436	0,217
Nuova (New) Cinquecento 1,2	07=>	650/995	<b>01.1054</b>	55183097	0,331
Nuova (New) Cinquecento 1,3 MJTD	07=>	640/1025	<b>01.1055</b>	55196302	0,715
Nuova (New) Cinquecento 1,4	07=>	625/1000	<b>01.1225</b>	55210048	0,705
600	59=>	420/2060	<b>01.107</b>	982761	0,238
600 D	63=>	425/2050	<b>01.108</b>	996179	0,229
Seicento all	92=>	300/590	<b>01.018</b>	7680262	0,173
Seicento Sporting	98=>	400/780	<b>01.0183</b>	46406430	0,217
Seicento 1108 Mpi	98=>	300/615	<b>01.1145</b>	46771188	0,177
850 all (with bracket)	65=>	510/1955	<b>01.112</b>	4112752	0,326
Panda 30 650cc	80=>	450/625	<b>01.396</b>	4406586	0,153
Panda 30 all (manual adjust)	80=>	430/600	<b>01.498</b>	4406586	0,149
Panda 45 all	80=>	300/515	<b>01.397</b>	4406587	0,126
Panda 750/1000/4X4/Young/Dance/D	86=>	370/565	<b>01.106</b>	7555958-7550409	0,128
Panda 750/1000	07/91=>	375/565	<b>01.000</b>	7706794	0,140
Panda Weber ie/Maquillage	07/91=>	390/585	<b>01.910</b>	7702089	0,165
Nuova (New) Panda 1,1 8v/1,2 8v	03=>	650/995	<b>01.1054</b>	55183097	0,331
Nuova (New) Panda 1,3 MJTD 51 kw	03=>	640/1025	<b>01.1055</b>	55196302	0,715
Nuova (New) Panda 1,4 16v	03=>	625/1000	<b>01.1225</b>	55210048	0,705
127 all (iron)	=>12/76	290/440	<b>01.124</b>	4305713-4235527	0,138
127 all	01=>05/77	285/465	<b>01.260</b>	4378669	0,143
127 900cc-147 Brazil 850cc	06/77=>09/81	295/460	<b>01.176</b>	5988527	0,114
127 all 1050cc	77=>	300/480	<b>01.258</b>	4395851	0,116
127 900cc (5 doors)	83=>	343/505	<b>01.495</b>	3933947	0,129
127 D-Panorama	83=>	325/485	<b>01.0281</b>	4358923	0,135
Uno all	83=>	330/630	<b>01.471</b>	4444079	0,127
Uno all-D 1,3-TD-Sting-1,0-1,1	11/86=>93	340/630	<b>01.167</b>	7592915	0,160
Uno D 1,7	87=>	340/650	<b>01.180</b>	7628544	0,181
Uno T ie	10/87=>	335/695	<b>01.512</b>	7599190	0,173
Uno D 1,3cc R/89	09/89=>	350/630	<b>01.307</b>	7677537	0,163
Uno 900-1,0-1,1-Trend	09/89=>	345/700	<b>01.306</b>	7679548	0,187
Uno 900-1,0-1,1-Trend-Selecta	06/93=>	330/685	<b>01.506</b>	7711880-7781085	0,185
Uno 1,3-1,4-T ie-TD-D 1,7	90=>93	350/630	<b>01.015</b>	7709460	0,163
Uno 900-1,0-1,1 (exc.Trend)	93=>	455/810	<b>01.072</b>	7727939	0,231





Cavo Frizione Autoregistrante - Selfadjusting Clutch Cables - à rattrapage Automatique - Samostaviteľná spojková lanka - Саморегулируемые тросы сцепления  
Cavo Frizione Registrazione Manuale - Manual Adjusting Clutch Cable - à réglage manuel - Spojkové lanko staviteľné ručně - Тросы сцепления ручного регулирования

**CAVI FRIZIONE - CLUTCH CABLES - CABLES DE DEBRAYAGE  
KUPPLUNGSSEILE - CABLES EMBRAGUE - CABOS DE EMBRAIAGEM  
LINKI SPRZĘGŁA - SPOJKOVÁ LANKA - ТРОСЫ СЦЕПЛЕНИЯ**

				OEM REF.	
<b>FIAT</b>					
Uno 1,6 (Sevel Argentina)	91=>	270/650	<b>01.0076</b>	46590638	0,430
Uno D 1,7	94=>	360/640	<b>01.0064</b>	7781087	0,191
Uno CS	87=>	355/650	<b>01.171</b>	5963181	0,149
Uno CS	89=>	380/650	<b>01.318</b>	7515915	0,160
Uno CS-Premio-Pick Up (Brazil)	06/91=>	350/630	<b>01.0065</b>	7520132-50007676	0,196
Duna all	87=>	355/650	<b>01.171</b>	5963181	0,149
Duna all	89=>	380/650	<b>01.318</b>	7515915	0,160
Palio/Siena 75-100 1,2-1,6-16v (exc.D)	97=>	350/685	<b>01.0357</b>	46522367-46522369-46740887	0,242
Palio D	97=>	370/725	<b>01.0358</b>	46522370	0,178
Palio/Strada		325/685	<b>01.1056</b>	46558766-46781018	0,279
Palio 75 1,2/Siena/Strada	97=>	307/787	<b>01.0613</b>	46736944	0,337
Palio	00=>	350/685	<b>01.0357</b>	46740888	0,242
Palio	00=>	307/787	<b>01.1233</b>	46788229	0,335
Punto all (exc.GT-TD)	93=>94	435/850	<b>01.271</b>	7735823-7798973	0,260
Punto GT-TD	93=>94	220/705	<b>01.445</b>	7738397-7780034	0,209
Punto all	03=>06/94	450/855	<b>01.0185</b>	46437478	0,316
Punto all	07/94=>	450/850	<b>01.0186</b>	7780036-46451736-46469621 46461939	0,337
Punto all (exc. TD)	97=>	450/850	<b>01.0186</b>	7780036-46451736-46469621 46461939	0,337
Punto TD	97=>	220/700	<b>01.0355</b>	46461941	0,224
128 type 2	=>72	330/525	<b>01.126</b>	4234276-4306698	0,154
128 (servo brake)	73=>	300/530	<b>01.127</b>	4305712-4264454	0,146
Ritmo 60-65 all	78=>	410/630	<b>01.320</b>	4379430	0,150
Ritmo 60-65-75 (servo brake)	80=>	380/630	<b>01.432</b>	4419451-4445326	0,176
Ritmo all (exc.D)	05/81=>	390/625	<b>01.453</b>	5936838	0,136
Ritmo all (exc.D)	10/82=>	410/640	<b>01.472</b>	5967096	0,149
Ritmo all (exc.D)	01/84=>	395/620	<b>01.120</b>	7542416-92511290	0,145
Ritmo (New) 60-70-80	01/85=>	395/625	<b>01.121</b>	7556324	0,179
Ritmo 100-D	01/85=>	395/600	<b>01.117</b>	7559911	0,178
Ritmo 130TC	01/85=>	410/620	<b>01.119</b>	7558218	0,197
Ritmo D	=>04/81	330/575	<b>01.441</b>	4431992	0,160
Ritmo D	05/81=>	330/580	<b>01.449</b>	5937115	0,125
Ritmo 105TC-125TC-130TC-D	10/82=>	395/620	<b>01.473</b>	5977381-7536184	0,155
Tipo all	88=>	345/710	<b>01.185</b>	7610378-7674443	0,216
Tipo TD	89=>	350/775	<b>01.308</b>	7649509-7670999-7722751 7785747	0,218
Tipo 1,6ie (Bosch)-1,7 D	90=>	530/735	<b>01.0187</b>	7690073-7710210-7722749	0,251
Tipo all	94=>	350/735	<b>01.0187</b>	7784315	0,251
Bravo/Brava 1,4	95=>	410/940	<b>01.0605</b>	46453539-7770205	0,403
Bravo/Brava 1,6-1,8-D	=>06/95	360/860	<b>01.0189</b>	7771565	0,258
Bravo/Brava 1,6-1,8-1,9 D	07/95=>98	1065/1475	<b>01.0600</b>	46448106-46797595	0,529





Cavo Frizione Autoregistrante - Selfadjusting Clutch Cables - à rattrapage Automatique - Samostavitelná spojková lanka - Саморегулируемые тросы сцепления  
Cavo Frizione Registrazione Manuale - Manual Adjusting Clutch Cable - à réglage manuel - Spojkové lanko staviteľné ručné - Тросы сцепления ручного регулирования

**CAVI FRIZIONE - CLUTCH CABLES - CABLES DE DEBRAYAGE  
KUPPLUNGSSEILE - CABLES EMBRAGUE - CABOS DE EMBRAIAGEM  
LINKI SPRZĘGŁA - SPOJKOVÁ LANKA - ТРОСЫ СЦЕПЛЕНИЯ**

				OEM REF.	
<b>FIAT</b>					
Bravo/Brava 1,6-1,8-TD 75/100	96=>	1060/1510	<b>01.0188</b>	46467631-46475314 46475319-46472971	0,515
124	66=>	735/930	<b>01.114</b>	4141755-4152672	0,290
124-124 Special (exc.Coupé/Spyder)	68=>	740/935	<b>01.115</b>	4172525	0,266
124-124 Special-Special T (exc.Coupé/Spyder)	72=>	760/960	<b>01.116</b>	4264074-4285116	0,283
124 Coupé-Spyder	=>73	710/900	<b>01.118</b>	4231330	0,255
124 Coupé-Spyder	73=>	710/905	<b>01.157</b>	4297126	0,301
131 all	=>03/78	1010/1220	<b>01.129</b>	4336454	0,424
131 all-D (Bosch)	4/78=>	1010/1225	<b>01.322</b>	4395749-4441735	0,441
131 (air cond.)	04/78=>	945/1150	<b>01.323</b>	4400487-4477528	0,395
131 L-CL-FL	=>81	945/1150	<b>01.323</b>	4477528-4400487	0,395
131 D (Cav)		1105/1330	<b>01.364</b>	4428452	0,490
Regata all	=>12/83	410/640	<b>01.472</b>	5967096	0,149
Regata all	=>84	395/620	<b>01.120</b>	7542416	0,145
Regata all	01/85=>	395/620	<b>01.121</b>	7556324	0,179
Regata D	85=>	395/600	<b>01.117</b>	7559911	0,178
Regata TD	=>03/87	385/670	<b>01.174</b>	7584093	0,189
Regata TD-1,6ie	04/87=>	375/660	<b>01.186</b>	7616775	0,199
Marea 1,6-1,8	=>06/95	360/860	<b>01.0189</b>	7771565	0,258
Marea all BZ	96=>	1065/1475	<b>01.0600</b>	46448106	0,529
Marea 1,6-1,8-TD 75/100	96=>	1060/1510	<b>01.0188</b>	46467631-46475314 46475319-46472971	0,515
Tempra TD	89=>	350/775	<b>01.308</b>	7649509-7670999-7722751 7785747	0,218
Tempra all	90=>	345/710	<b>01.185</b>	7610378-7674443	0,216
Tempra 1,6ie (Bosch)-1,7 D	90=>	530/735	<b>01.0187</b>	7690073-7710210-7722749	0,251
Tempra 1,6 (Brazil)		395/620	<b>01.121</b>	7556324	0,179
Tempra all	94=>	350/735	<b>01.0187</b>	7784315	0,251
125-125 Special	69=>	885/1100	<b>01.122</b>	4175027-4154803	0,320
132 all	=>3/77	885/1100	<b>01.122</b>	4175027-4154803-4152672	0,320
132 all	04/77=>	885/1130	<b>01.259</b>	4380878	0,308
132 D (Bosch)	77=>	885/1130	<b>01.259</b>	4380878	0,308
132 D (Cav)	81=>	900/1160	<b>01.339</b>	4429871	0,377
Argenta all	81=>	885/1130	<b>01.259</b>	4380878	0,308
Argenta D (Bosch)	81=>	885/1130	<b>01.259</b>	4380878	0,308
Argenta D (Cav)	81=>	900/1160	<b>01.339</b>	4429871	0,377
Croma all (manual adjust)	=>88	670/960	<b>01.097</b>	82424220	0,400
Croma all (manual adjust)	89=>	690/920	<b>01.098</b>	82435483	0,368
Multipla all	98=>	425/870	<b>01.0617</b>	46538236	0,393

Cavo Frizione Autoregistrante - Selfadjusting Clutch Cables - à rattrapage Automatique - Samostavitelná spojková lanka - Саморегулируемые тросы сцепления  
Cavo Frizione Registrazione Manuale - Manual Adjusting Clutch Cable - à réglage manuel - Spojkové lanko staviteľné ručné - Тросы сцепления ручного регулирования

**CAVI FRIZIONE - CLUTCH CABLES - CABLES DE DEBRAYAGE  
KUPPLUNGSSEILE - CABLES EMBRAGUE - CABOS DE EMBRAIAGEM  
LINKI SPRZĘGŁA - SPOJKOVÁ LANKA - ТРОСЫ СЦЕПЛЕНИЯ**

				OEM REF.	
<b>FIAT</b>					
Barchetta	95=>	310/765	<b>01.1142</b>	46724233	0,226
Doblò all (exc.D)	03/01=>	250/730	<b>01.1089</b>	46816591	0,316
Ulisse 2,0-TDS (a/a)	95=>	410/765	<b>01.1103</b>	1476637080-1479128080	0,576
Ulisse 2,0-TD (manual adjust)	95=>	360/760	<b>01.0078</b>	1476637080-1479128080	0,536
Ulisse TB/1,9 TD (a/a)	95=>	550/855	<b>01.1104</b>	1476638080-1480346080	0,661
Ulisse TB/1,9 TD (manual adjust)	95=>	515/855	<b>01.0079</b>	1476638080-1480346080	0,555
Ulisse 2,0 16v (manual adjust)	95=>	655/965	<b>01.1146</b>	1487268080-2150AC	0,488
Ulisse 2,1 TD (a/a)	96=>	765/1085	<b>01.1105</b>	1476128080-2150P6	0,472
Ulisse 2,1 TD (manual adjust)	96=>	750/1095	<b>01.0356</b>	1476128080-2150P6	0,405
Ulisse 2,0 (a/a)	00=>	685/965	<b>01.1118</b>	1487268080-2150AC	0,556
Ulisse 2,0-2,2 JTD (a/a)	00=>	695/995	<b>01.1119</b>	1487725080-2150AN	0,549
Dino Coupé-Spyder		1020/1210	<b>01.010</b>	4257001	0,461
130 B		1270/1495	<b>01.008</b>	4330114	0,536







**FIAT - Commercial Vehicle**

N 500 Giardiniera	=>64	330/2215	<b>01.104</b>	4050451	0,253
500 F Giardiniera	=>74	330/2200	<b>01.105</b>	4119634-4286563-4184167	0,235
500 F Giardiniera	74=>	330/2150	<b>01.257</b>	4296472	0,247
600 D-M	63=>	430/2660	<b>01.109</b>	984816-4063590	0,277
600 T	=>69	400/2660	<b>01.110</b>	4109109	0,305
850 T-900 T-900 E-Van/Furg-Break/FAM		480/2650	<b>01.113</b>	4137242	0,301
Fiorino (900cc)	77=>	295/460	<b>01.176</b>	5988527	0,114
Fiorino (900cc-1050cc)	81=>	300/480	<b>01.258</b>	4395851	0,116
Fiorino D	83=>	325/485	<b>01.0281</b>	4358923	0,135
Fiorino/Spazio (Sevel Argentina)		325/485	<b>01.0281</b>	1481583	0,135
Fiorino BZ-D-Penny	88=>	355/650	<b>01.171</b>	5963181	0,149
Fiorino D	89=>	380/650	<b>01.318</b>	7515915	0,160
Fiorino BZ-D	06/91=>93	350/630	<b>01.0065</b>	7520132-50007676	0,196
Fiorino BZ-D	94=>	310/660	<b>01.0280</b>	7521110	0,234
Fiorino BZ-D	97=>	220/678	<b>01.1121</b>	50007727	0,239
Fiorino BZ-D	98=>	215/698	<b>01.1122</b>	50011681	0,250
242 all	77=>	1925/2120	<b>01.241</b>	5437678	0,709
Campagnola BZ	=>79	1170/1450	<b>01.265</b>	1377015	0,429
Campagnola D	80=>	1020/1270	<b>01.388</b>	4458685	0,426
Scudo 2,0-TDS (a/a)	95=>	410/765	<b>01.1103</b>	1476637080-1479128080	0,576

Cavo Frizione Autoregistrante - Selfadjusting Clutch Cables - à rattrapage Automatique - Samostaviteľná spojková lanka - Саморегулируемые тросы сцепления  
Cavo Frizione Registrazione Manuale - Manual Adjusting Clutch Cable - à réglage manuel - Spojkové lanko staviteľné ručně - Тросы сцепления ручного регулирования





**CAVI FRIZIONE - CLUTCH CABLES - CABLES DE DEBRAYAGE  
KUPPLUNGSSEILE - CABLES EMBRAGUE - CABOS DE EMBRAIAGEM  
LINKI SPRZĘGŁA - SPOJKOVÁ LANKA - ТРОСЫ СЦЕПЛЕНИЯ**

				OEM REF.	
<b>FIAT - Commercial Vehicle</b>					
Scudo 1,6 D (manual adjust)	95=>	360/760	<b>01.0078</b>	1476637080-1479128080	0,536
Scudo TB (a/a)	95=>	550/855	<b>01.1104</b>	1476638080-1480346080	0,661
Scudo 2,0 TB-1,9 TD (manual adjust)	95=>	515/855	<b>01.0079</b>	1476638080-1480346080	0,555
Scudo 2,1 TD (a/a)	96=>	765/1085	<b>01.1105</b>	1476128080-2150P6	0,472
Scudo 2,1 TD (manual adjust)	97=>	750/1095	<b>01.0356</b>	1476128080-2150P6	0,405
Scudo 1,9 TD-2,0 BZ (a/a)	95=>	685/965	<b>01.1118</b>	1487268080-2150AC	0,556
Scudo 1,9 TD-2,0 BZ (manual adjust)	95=>	655/970	<b>01.1146</b>	1487268080-2150AC	0,488
Scudo 2,0 JTD (a/a)	95=>	695/995	<b>01.1119</b>	2150AN-1487725080	0,549
Scudo 2,0 JTD 110 cv CF3 8v (manual adjust)	95=>	660/1000	<b>01.1147</b>	2150AN-1487725080	0,494
Ducato all	81=>	920/1190	<b>01.451</b>	7724708-4460471	0,355
Ducato D-4X4-RL 90	90=>	920/1190	<b>01.451</b>	7724708-4460471	0,355
Ducato BZ 10/14-2,5 D	94=>	540/1035	<b>01.0282</b>	1310131080-2150J2-2150T4	0,289
Ducato BZ 18-D 2,5 TDI/Eco	94=>	650/1080	<b>01.0283</b>	1310132080-2150J3-2150T7 1318446080	0,429
Ducato D-TD 2,0	94=>	555/1090	<b>01.0284</b>	1312633080-2150J4-2150T6	0,540
Ducato 2,8 D	98=>	910/1438	<b>01.0618</b>	1322174080-1335052080 1329672080-2150AV-2150Y5	0,431
Ducato 1,9 TD gear ML	98=>	925/1480	<b>01.0372</b>	1321581080-132967280 1335053080-2150AP-2150Z7	0,730
Ducato Jp-Psa	94=>01	535/1075	<b>01.1234</b>	1318449080-1311068080	0,224
Ducato D (ch. 6144101-)	06/01=>	660/1075	<b>01.1144</b>	1336423080	0,274
Talento all	81=>	920/1190	<b>01.451</b>	7724708-4460471	0,355
<b>FIAT IVECO</b>					
Daily/Grinta 30-32-35-40.8	=>11/94	995/1205	<b>01.387</b>	93800352	0,375
Daily/Grinta 30-35-40.8-30-32-35-40 SC (II° s.)	12/94=>	995/1190	<b>01.612</b>	93805586-93802517	0,364
Daily T 45.10-49.10	88=>	950/1125	<b>01.706</b>	93807127	0,381
Daily/Grinta T (I° s.)	03/85=>	990/1250	<b>01.177</b>	93807157	0,372
Daily T 35.10 (II° s.)-49.10 (II° s.)		955/1120	<b>01.814</b>	93812661-93809100	0,346
Daily all T (series "S")	=>92	920/1230	<b>01.0235</b>	93820871-93809922	0,384
New Daily 35.8-49.10-49.12 GD	96=>	1610/1935	<b>01.1143</b>	93820874	0,581

<b>FORD</b>					
Ka II all 1,2	11/08=>	650/995	<b>01.1054</b>	1558930	0,331
Ka II all 1,3 JTD	11/08=>	640/1025	<b>01.1054</b>	1558931	0,715
Fiesta all	76=>	430/670	<b>01.333</b>	6109041-6066678-6046205	0,154
Fiesta all (servo break)	76=>	430/670	<b>01.334</b>	6066679-6046206-6143071	0,155
Fiesta all	89=>	450/710	<b>01.313</b>	6174503-6612561	0,167
Nuova (New) Fiesta 16v all	93=>	360/680	<b>01.0285</b>	6900282	0,160
Escort all	=>75	840/980	<b>01.175</b>	1475933	0,328
Escort all	75=>	810/1010	<b>01.264</b>	1561360	0,265
Escort all	80=>	945/1230	<b>01.502</b>	6091957-6139192	0,348
Escort 1,6i	08/83=>	1100/1380	<b>01.309</b>	6140343-83AB7K553AA	0,411
Escort all	86=>	475/740	<b>01.312</b>	6082434-6166128	0,194
Escort all (exc.ABS)	09/90=>	520/810	<b>01.020</b>	6575413-91AB7K553AD	0,188
Escort all (ABS)	09/90=>	700/1010	<b>01.021</b>	6492352-91AB7K553EA	0,261

Cavo Frizione Autoregistrante - Selfadjusting Clutch Cables - à rattrapage Automatique - Samostaviteľná spojková lanka - Саморегулируемые тросы сцепления  
Cavo Frizione Registrazione Manuale - Manual Adjusting Clutch Cable - à réglage manuel - Spojkové lanko staviteľné ručně - Тросы сцепления ручного регулирования

**CAVI FRIZIONE - CLUTCH CABLES - CABLES DE DEBRAYAGE  
KUPPLUNGSSEILE - CABLES EMBRAGUE - CABOS DE EMBRAIAGEM  
LINKI SPRZĘGŁA - SPOJKOVÁ LANKA - ТРОСЫ СЦЕПЛЕНИЯ**

				OEM REF.	
<b>FORD</b>					
Escort 1,6-1,8 16v-1,8 D	90=>92	475/785	<b>01.0328</b>	6900281-6779976	0,180
Escort EA	90=>95	465/786	<b>01.1070</b>	1016071-94AB7K553AB	0,179
Escort FA HCS-B5-IB5 Zetec-E	95=>01	465/803	<b>01.1071</b>	1038239-6789186-94AB7K553FB	0,181
Escort FA HCS-B5-IB5 TR-CVH 1,6	95=>01	465/793	<b>01.1072</b>	1038238-94AB7K553AC	0,178
Escort FA Zetec 1,8 Efi-DOHC Efi 16v D 1,8 TI/TC	95=>01	440/862	<b>01.1073</b>	1038241-94AB7K553HC	0,172
Capri 1,3-1,6	72=>73	925/1100	<b>01.342</b>	1523359	0,469
Capri 1,6-2,0 MK I	11/70=>01/74	950/1115	<b>01.172</b>	1486791-1537014	0,360
Capri 1,6	75=>	970/1090	<b>01.099</b>	1555138-6066670	•
Orion all	80=>	945/1230	<b>01.502</b>	6091957-6139192	0,348
Orion 1,6i	08/83=>	1100/1380	<b>01.309</b>	6140343-83AB7K553AA	0,411
Orion all	86=>	475/740	<b>01.312</b>	6082434-6166128	0,194
Orion all (exc.ABS)	09/90=>	520/810	<b>01.020</b>	6575413-91AB7K553AD	0,188
Orion all (ABS)	09/90=>	700/1010	<b>01.021</b>	6492352-91AB7K553EA	0,261
Orion 1,6-1,8-16v-1,8 D	90=>92	475/785	<b>01.0328</b>	6900281-6779976	0,180
Orion EA	90=>95	465/786	<b>01.1070</b>	1016071-94AB7K553AB	0,179
Taunus 1,3	77=>	990/1220	<b>01.340</b>	1537005-6066664	0,363
Taunus 1,6	77=>	990/1220	<b>01.411</b>	6058146-76BB7K553HB	0,373
Taunus 2,0	80=>	970/1260	<b>01.508</b>	6103198-6085366	0,328
Taunus 2,0-2,3 6v	80=>	965/1230	<b>01.509</b>	6103197-6085364	0,353
Sierra 1,3-1,6	82=>	890/1190	<b>01.549</b>	6124274-83BB7K553AD	0,316
Sierra 1,3-1,6 type E	84=>	900/1175	<b>01.025</b>	6142026	0,310
Sierra 1,6	83=>84	970/1230	<b>01.187</b>	6128761-83BB7K553JA	0,317
Sierra 1,6	84=>	1000/1200	<b>01.316</b>	6142027-6151767	0,325
Sierra 2,0 (in line motor)	82=>	1080/1415	<b>01.550</b>	6128542-83BB7K553EE	0,369
Sierra 2,0	83=>	900/1190	<b>01.188</b>	6120915-83BB7K553EC	0,298
Sierra 1,8-2,0 (TL motor)	84=>	1130/1415	<b>01.317</b>	1629947-83BB7K553EF	0,364
Sierra 1,8-2,0	87=>	1270/1545	<b>01.319</b>	6166222-6194817	0,433
Sierra 1,8-2,0	90=>	1145/1430	<b>01.207</b>	1647679	0,396
Sierra 2,8 (6 cyl.)	84=>	1000/1320	<b>01.325</b>	1629948-6156055 83BB7K553FG	0,362
Sierra 2,8	87-89	1075/1380	<b>01.1240</b>	6166225-6191368	•
Sierra D	83=>	1100/1435	<b>01.190</b>	6122136-83BB7K553GC	0,374
Sierra D	87=>	1100/1400	<b>01.338</b>	6156056-83BB7K553GF	0,391
Sierra XR4i	=>09/82	970/1350	<b>01.026</b>	1623964-83BB7K553FF	0,399
Sierra XR4i	10/82=>	1000/1350	<b>01.027</b>	6131308-6128543	0,369
Sierra 2,0i DOHC (with cond.)	89=>	1385/1675	<b>01.1235</b>	6468330	0,600
Sierra 2,0i DOHC (no cond.)	89=>	1225/1520	<b>01.1236</b>	6754367-6166222-6194817	0,493
Sierra 1,6	87=>	865/1180	<b>01.0191</b>	6178916	0,311
Mondeo 1,6-1,8-D	93=>	410/670	<b>01.0286</b>	6966930-7105817	0,249
Granada 2,0	76=>77	850/1110	<b>01.029</b>	6066680	0,334
Granada 2,0	78=>	860/1140	<b>01.030</b>	1610384	0,315
Granada 2,3-2,6	72=>	1055/1250	<b>01.028</b>	6041089	0,362
Granada 2,5-2,8	78=>	970/1270	<b>01.501</b>	6066684-6066681	0,325

Cavo Frizione Autoregistrante - Selfadjusting Clutch Cables - à rattrapage Automatique - Samostavitelná spojková lanka - Саморегулируемые тросы сцепления  
Cavo Frizione Registrazione Manuale - Manual Adjusting Clutch Cable - à réglage manuel - Spojkové lanko staviteľné ručně - Тросы сцепления ручного регулирования

**CAVI FRIZIONE - CLUTCH CABLES - CABLES DE DEBRAYAGE  
KUPPLUNGSSEILE - CABLES EMBRAGUE - CABOS DE EMBRAIAGEM  
LINKI SPRZĘGŁA - SPOJKOVÁ LANKA - ТРОСЫ СЦЕПЛЕНИЯ**

				<b>OEM REF.</b>	
---	---	---	--	-----------------	---

<b>FORD</b>					
Granada D	76=>	980/1255	<b>01.499</b>	6066685	0,381
Scorpio 2,3-2,6-2,8	85=>	1000/1320	<b>01.325</b>	6156055	0,362
Scorpio 1,8-2,0-2,0i	85=>	1100/1400	<b>01.0287</b>	6153882-6153883 85GB7K553AA-85GB7K553BA	0,417
Scorpio D	83=>87	1100/1435	<b>01.190</b>	6122136-83BB7K553GC	0,374
Scorpio D	88=>	1100/1400	<b>01.343</b>	6191953-6608691	0,430
Scorpio 2,0i	90=>91	1300/1590	<b>01.1090</b>	6193139-6608690-6191795	0,487







<b>FORD - Commercial Vehicle</b>					
Transit D	=>75	830/1035	<b>01.504</b>	1538102-71VB7K553A2B	0,315
Transit D	75=>	1000/1200	<b>01.266</b>	6024977-75VB7K553E2A	0,367
Transit 75-190 D	72=>75	960/1140	<b>01.269</b>	1538103	0,344
Transit 1,6 (OHV)	75=>	925/1160	<b>01.031</b>	6040585-75VB7K553BIB	•
Transit D	76=>	760/1000	<b>01.267</b>		0,314
Transit D	78=>	1045/1280	<b>01.466</b>	6046700-78VB7K553DIA	0,404
Transit 1,6-2,0	86=>	865/1160	<b>01.199</b>	6156501-6158521	0,343
Transit D	86=>	1140/1400	<b>01.195</b>	6161414-6177410	0,455
Transit 2,0 all	08/94=>	1130/1545	<b>01.0302</b>	1011805-1086288	0,526
Transit 2,5 D all	08/94=>	1130/1490	<b>01.0301</b>	1011806-7343294 96VB7K553CA	0,489

<b>HONDA</b>					
Concerto 1,4 all	=>90	1288/1468	<b>01.0295</b>	22910SK3G10-22910SK3G11	0,547
Concerto 1,4 all	91=>	1288/1468	<b>01.0295</b>	22910SK3Z30	0,547
Concerto 1,6 all	=>90	1288/1468	<b>01.0295</b>	22910SK3G30-22910SK3G31 22910SK3G32	0,547
Concerto 1,6 all	=>91	1288/1468	<b>01.0295</b>	22910SK3Z40	0,547
Civic 1,2	73=>79	1150/1290	<b>01.540</b>	22910634673	0,488
Civic 1,3	80=>83	1320/1450	<b>01.0005</b>	22910SA0673-22910SA0674	0,552
Civic 1,3	84=>87	1380/1520	<b>01.0006</b>	22910SB2672-22910SA3A01	0,536
Civic 1,5-1,6	75=>79	1100/1295	<b>01.541</b>	22910657670	0,548
Civic 1,5-1,6-CRX	80=>87	1380/1520	<b>01.0006</b>	22910SB2672-22910SA3A01	0,536
Civic 1,5	80=>	1300/1460	<b>01.0008</b>	22910SA0670	0,469
Civic (exc.4WD)	84=>87	1350/1485	<b>01.0009</b>	22910SB6671	0,535
Civic 4WD	84=>87	1355/1485	<b>01.0010</b>	22910SD9671	0,652
Civic all	87=>	1365/1530	<b>01.0011</b>	22910SH3A05	0,652
Civic Wagon (exc.4WD)	88=>	1390/1505	<b>01.0297</b>	22910SH5A02-22910SH5A03	0,622
Civic 4WD	88=>	1400/1540	<b>01.0296</b>	22910SH5A62-22910AH5A63	•
Accord	82=>84	1420/1570	<b>01.0012</b>	22910SA5670-22910SA5671	0,650
Accord (exc.SEI)	85=>	1650/1800	<b>01.0013</b>	22910SA5672	0,652
Accord SEI	85=>	1665/1810	<b>01.0014</b>	22910SD7671	0,786
Accord all	86=>89	1750/1910	<b>01.0015</b>	22910SE0A01	0,564
Accord all	=>82	1380/1520	<b>01.0006</b>	22910SB2672	0,536

Cavo Frizione Autoregistrante - Selfadjusting Clutch Cables - à rattrapage Automatique - Samostavitelná spojková lanka - Саморегулируемые тросы сцепления  
Cavo Frizione Registrazione Manuale - Manual Adjusting Clutch Cable - à réglage manuel - Spojkové lanko staviteľné ručně - Тросы сцепления ручного регулирования

**CAVI FRIZIONE - CLUTCH CABLES - CABLES DE DEBRAYAGE  
KUPPLUNGSSEILE - CABLES EMBRAGUE - CABOS DE EMBRAIAGEM  
LINKI SPRZĘGŁA - SPOJKOVÁ LANKA - ТРОСЫ СЦЕПЛЕНИЯ**

				<b>OEM REF.</b>	
<b>HONDA</b>					
Prelude	83=>87	1300/1450	<b>01.0016</b>	22910SB0670	•
Prelude Si	84=>87	1810/1965	<b>01.0017</b>	22910SF0671	•

<b>HYUNDAI</b>					
Pony 1,2-1,4	78=>	665/830	<b>01.201</b>	4151011010	0,316
Atos Prime 1,0 12v	96=>00	595/795	<b>01.1091</b>	4151002010	0,577
Atos 1,0 12v	01=>	595/795	<b>01.1091</b>	4151002010	0,577
Excel (USA mod.)	86=>	1050/1280	<b>01.0018</b>	4151021010	0,533
Stellar/Sonata	89=>	980/1200	<b>01.0298</b>	4151031100	0,527

<b>INNOCENTI</b>					
Minitre	82=>	550/670	<b>01.534</b>	558221104	0,304
Minitre T	09/83=>	550/700	<b>01.552</b>	558221204	0,244
Minitre D	84=>	520/660	<b>01.132</b>	558210104	0,255
Mini 650	85=>	510/655	<b>01.134</b>	558200204	0,222
500	87=>	550/650	<b>01.344</b>	558202104	0,272
990-990 T-990 D	87=>	540/700	<b>01.345</b>	558250204	0,338
Elba Csl	91=>96	380/650	<b>01.318</b>	7515915	0,160
Elba all	92=>	350/630	<b>01.0065</b>	7520132	0,196

<b>ISUZU</b>					
Piazza T	90=>	675/940	<b>01.0020</b>	8944675714	0,412
KB Van 20-21-22-25-26-27	81=>87	1340/1575	<b>01.0021</b>	8942381851-8942381853	0,581
LUV	80=>	1310/1560	<b>01.0023</b>	94027192-94028795	0,561





<b>KIA</b>					
Rio	02=>	475/733	<b>01.1140</b>	OK30A41150C	0,268
Rio Brid			<b>01.1141</b>	KDX1841150B	•
Picanto	04=>	665/840	<b>01.1216</b>	4151007100-4151007110 4151007120	0,370

<b>LADA VAZ</b>					
Samara (I° s.)	=>87	480/720	<b>01.006</b>	21081602210	0,287
Samara (II° s.)	87=>	480/735	<b>01.007</b>	21091602210	0,299

<b>LANCIA</b>					
A 112 all	=>04/77	290/440	<b>01.124</b>	4235527-4305713	0,138
A 112 all	05/77=>	285/465	<b>01.260</b>	4378669	0,143





Cavo Frizione Autoregistrante - Selfadjusting Clutch Cables - à rattrapage Automatique - Samostavitelná spojková lanka - Саморегулируемые тросы сцепления  
Cavo Frizione Registrazione Manuale - Manual Adjusting Clutch Cable - à réglage manuel - Spojkové lanko stavitelné ručně - Тросы сцепления ручного регулирования

**CAVI FRIZIONE - CLUTCH CABLES - CABLES DE DEBRAYAGE  
KUPPLUNGSSEILE - CABLES EMBRAGUE - CABOS DE EMBRAIAGEM  
LINKI SPRZĘGŁA - SPOJKOVÁ LANKA - ТРОСЫ СЦЕПЛЕНИЯ**

				OEM REF.	
<b>LANCIA</b>					
A 112 all	79=>81	300/480	<b>01.258</b>	4395851	0,116
A 112 all	81=>	300/470	<b>01.464</b>	82365671	0,307
Y10 all	85=>	340/610	<b>01.128</b>	5987926	0,128
Y10 all	05/90=>	345/635	<b>01.050</b>	7704066	0,176
Y10 all (exc.4WD)	92=>	450/770	<b>01.625</b>	7715102	0,220
Y10 4WD	92=>	340/630	<b>01.626</b>	7715688	0,181
Y10 all (exc.4WD)	94=>	440/770	<b>01.0069</b>	7786996	0,218
Y10 4WD	94=>	340/630	<b>01.0070</b>	7784941	0,188
Y all	96=>	450/850	<b>01.0186</b>	46451736-46469621-46461939	0,337
Delta 1,3-1,5 all	79=>	475/695	<b>01.398</b>	82353561-82401672	0,213
Delta HF-GT 1,6	83=>86	460/655	<b>01.476</b>	82384558-82423334	0,160
Delta HF-GT 1,6	86=>	400/680	<b>01.205</b>	82421773	0,215
Delta 1,3-1,5-1,6-TD	10/88=>	380/670	<b>01.034</b>	82456527-82462183	0,233
Delta 4WD	86=>	450/645	<b>01.206</b>	82422002-82446624	0,295
Delta 1,4-1,6	93=>	400/750	<b>01.0067</b>	7756520	0,229
Delta 1,8	93=>	340/755	<b>01.0068</b>	7766558	0,239
Delta TD	94=>	350/735	<b>01.0187</b>	7781507	0,251
Prisma 1,3-1,5 all	79=>	475/695	<b>01.398</b>	82353561-82401672	0,213
Prisma 1,6-D-TD	83=>86	460/655	<b>01.476</b>	82384558-82423334	0,160
Prisma 1,6-D-TD	86=>	400/680	<b>01.205</b>	82421773	0,215
Prisma 1,3-1,5-1,6-TD	10/88=>	380/670	<b>01.034</b>	82456527-82462183	0,233
Prisma 4WD	86=>	450/645	<b>01.206</b>	82422002-82446624	0,295
Flavia 2,0		475/705	<b>01.140</b>	81817265	0,178
Fulvia all (5 speed)/Coupé		475/705	<b>01.140</b>	81817265	0,178
Beta	75=>	395/740	<b>01.138</b>	82310983-82350878	0,197
Trevi all	75=>	395/740	<b>01.138</b>	82310983-82350878	0,197
Dedra 1,6-1,8	89=>	345/710	<b>01.185</b>	7674443-7610378	0,216
Dedra 1,6 (Bosch)	05/90=>	350/735	<b>01.0187</b>	7690073-7710210-7722749	0,251
Dedra 1,6 all	94=>	340/720	<b>01.0200</b>	7781509	0,249
Dedra 1,8-2,0-TD	89=>	350/775	<b>01.308</b>	7670999-7649509-7722751	0,218
Dedra 1,8-2,0-TD	05/90=>	345/770	<b>01.036</b>	7691166-7710212	0,241
Dedra 1,8-2,0-TD	94=>	340/755	<b>01.0068</b>	7766558	0,239
Gamma	77=>	370/645	<b>01.439</b>	82345354-82350880	•
Thema all (manual adjust)	=>88	670/960	<b>01.097</b>	82424220	0,400
Zeta TB (a/a)	94=>02	550/855	<b>01.1104</b>	1476638080-1480346080	0,661
Zeta TB (manual adjust)	94=>02	515/855	<b>01.0079</b>	1476638080	0,555
Zeta 2,0 ie TB-2,0 TD-2,0 16v (a/a)	94=>02	765/1085	<b>01.1105</b>	1476128080	0,472
Zeta 2,0 ie TB-2,0 TD-2,0 16v (manual adjust)	94=>02	750/1095	<b>01.0356</b>	1476128080	0,405

Cavo Frizione Autoregistrante - Selfadjusting Clutch Cables - à rattrapage Automatique - Samostaviteľná spojková lanka - Саморегулируемые тросы сцепления  
Cavo Frizione Registrazione Manuale - Manual Adjusting Clutch Cable - à réglage manuel - Spojkové lanko staviteľné ručně - Тросы сцепления ручного регулирования

**CAVI FRIZIONE - CLUTCH CABLES - CABLES DE DEBRAYAGE  
KUPPLUNGSSEILE - CABLES EMBRAGUE - CABOS DE EMBRAIAGEM  
LINKI SPRZĘGŁA - SPOJKOVÁ LANKA - ТРОСЫ СЦЕПЛЕНИЯ**

				OEM REF.	
<b>LANCIA</b>					
Zeta 2,0 16v CEE F3 (a/a)	94=>02	685/965	<b>01.1118</b>	1487268080	0,556
Zeta 2,0 16v CEE F3 (manual adjust)	94=>02	655/965	<b>01.1146</b>	1487268080	0,488
Zeta 2,0 TD (a/a)	95=>	410/765	<b>01.1103</b>	1476637080-1479128080	0,576
Zeta 2,0 TD (manual adjust)	95=>	360/760	<b>01.0078</b>	1476637080-2150S4-1479128080	0,536
Zeta 2,0 JTD (a/a)	00=>	695/995	<b>01.1119</b>	1487725080-2150AN	0,549

<b>MAZDA</b>					
323 GLC	77=>80	530/700	<b>01.551</b>	395841150B	0,359
323 GLC	81=>85	480/730	<b>01.701</b>	BA2941150A	0,309
323 all	86=>	540/765	<b>01.0024</b>	BF6741150C	0,485
626 all	83=>85	520/760	<b>01.0025</b>	GA9741150D	0,489

<b>MERCEDES</b>					
MB 100	87=>	1000/1450	<b>01.095</b>	6312930238-6312930638	0,523
MB 130-150		1510	<b>01.1120</b>	6312930038	0,375

<b>MITSUBISHI</b>					
Colt all	80=>	1150/1345	<b>01.0026</b>	MB012071	0,489
Colt/Lancer D	84=>05/86	1100/1345	<b>01.0201</b>	MB527464	0,705
Colt/Lancer	06/86=>	1150/1395	<b>01.0202</b>	MB484815-MB527467	0,475
Colt/Lancer 1,5	92=>	1240/1450	<b>01.0027</b>	MB698993	0,566
Lancer/Celeste all	80=>	1050/1260	<b>01.0029</b>	MB011949	0,390
Galant 1,6	78=>	580/805	<b>01.554</b>	MB011955	0,295
Galant 1,6-1,8-2,0	85=>88	1130/1320	<b>01.0030</b>	MB012288	0,528
L300 Van/Delica	79=>86	1835/2035	<b>01.0619</b>	MB012466	•
L300 Van all	87=>	1853/2032	<b>01.0620</b>	MB527400	0,720
Pick-Up L200/Forte LO23-26P 2WD	79=>86	640/825	<b>01.0621</b>	MB012460-MB012060	0,292
Pick-Up L200/Forte LO23-26P 2WD	79=>86	609/797	<b>01.0622</b>	MB012475	•
Pick-Up L200/Forte all	87=>90	654/870	<b>01.0623</b>	MB598411-MB527073	0,320

<b>NISSAN</b>					
Almera 1,4-1,6	95=>	500/755	<b>01.0624</b>	307701M200-307702M115	0,303
Almera 2,0 GTI 16v	95=>	515/755	<b>01.0205</b>	307701M800	0,362
Micra all	10/82=>92	420/625	<b>01.0031</b>	3067005B00	0,324
Micra all	93=>	410/625	<b>01.0203</b>	307705F200	0,280
Micra all	99=>	400/655	<b>01.1232</b>	307706F610	0,266
Micra II 1,5 D	98=>02	450/760	<b>01.1250</b>	307706F800-307706F801	•
Pixo all	09=>	420/665	<b>01.1218</b>	306804A00B-23710M68K01	•
Cherry BZ	82=>86	450/670	<b>01.0032</b>	3067004A00	0,282
Cherry D	82=>86	530/720	<b>01.0033</b>	3067017A00	0,354

Cavo Frizione Autoregistrante - Selfadjusting Clutch Cables - à rattrapage Automatique - Samostaviteľná spojková lanka - Саморегулируемые тросы сцепления  
Cavo Frizione Registrazione Manuale - Manual Adjusting Clutch Cable - à réglage manuel - Spojkové lanko staviteľné ručně - Тросы сцепления ручного регулирования

**CAVI FRIZIONE - CLUTCH CABLES - CABLES DE DEBRAYAGE  
KUPPLUNGSSEILE - CABLES EMBRAGUE - CABOS DE EMBRAIAGEM  
LINKI SPRZĘGŁA - SPOJKOVÁ LANKA - ТРОСЫ СЦЕПЛЕНИЯ**

				<b>OEM REF.</b>	
---	---	---	--	-----------------	---

<b>NISSAN</b>					
Pulsar	89=>	560/770	<b>01.0034</b>	3077065A00-3077084A00	0,354
Pulsar	86=>89	565/800	<b>01.0204</b>	3077060A01	0,328
Pulsar 1,4-1,6	91=>	515/755	<b>01.0205</b>	3077062Y01-307701M800	0,362
Pulsar 2,0	91=>	465/725	<b>01.0349</b>	3077064Y01	0,362
Sentra BZ	82=>86	450/670	<b>01.0032</b>	3067004A00	0,282
Sentra D	82=>86	530/720	<b>01.0033</b>	3067017A00	0,354
Sentra	89=>	560/770	<b>01.0034</b>	3077065A00-3077084A00	0,354
Sentra	86=>89	565/800	<b>01.0204</b>	3077060A01	0,328
Sentra 1,4-1,6	91=>	515/755	<b>01.0205</b>	3077062Y01-307701M800	0,362
Sentra 2,0	91=>	465/725	<b>01.0349</b>	3077064Y01	0,362
Sunny B11	82=>86	450/670	<b>01.0032</b>	3067004A00	0,282
Sunny B11 D	82=>86	530/720	<b>01.0033</b>	3067017A00	0,354
Sunny B11	89=>	560/770	<b>01.0034</b>	3077065A00-3077084A00	0,354
Sunny B11	86=>89	565/800	<b>01.0204</b>	3077060A01	0,328
Sunny B11 1,4-1,6	91=>	515/755	<b>01.0205</b>	3077062Y01-307701M800	0,362
Sunny 2,0	91=>	465/765	<b>01.0349</b>	3077064Y01	0,362
Stanza 1,6	82=>	510/645	<b>01.0035</b>	30670D1200	0,292
Primera 1,6	91=>	530/735	<b>01.0036</b>	3077099J11	0,340
Primera 2,0	91=>	480/695	<b>01.0037</b>	3077097J10	0,349
Primera 2,0 GT	91=>	500/720	<b>01.0038</b>	3077094J10	0,330
Primera P11		545/740	<b>01.1149</b>	307702F015	0,353
Primera P11		505/720	<b>01.1150</b>	307702F216-307702F221	0,338
Primera W10-W10 Kombi		510/765	<b>01.1151</b>	3077081N00-3077081N05	0,357
Primera W10 Kombi Abs		485/765	<b>01.1152</b>	3077083N00-3077083N05	•
200 ZX	95=>	515/755	<b>01.0205</b>	307701M800	0,362







<b>NISSAN - Commercial Vehicle</b>					
Vanette		1460/1705	<b>01.0039</b>	30680Y9501	0,532
Kubistar all 1,2-1,4	04=>	680/960	<b>01.0303</b>	3067000QAC	0,712
Kubistar all 1,5 D	04=>	658/960	<b>01.1162</b>	3067000QAD	0,750

<b>OPEL</b>					
Corsa all	82=>	400/690	<b>01.524</b>	669132-669157	0,198
Corsa B all	93=>	480/730	<b>01.0071</b>	669186-90446929	0,247
Corsa	09/96=>	410/795	<b>01.0193</b>	669187-90522447	0,230
Corsa 1,0 (3 cyl.)	98=>	440/840	<b>01.0628</b>	669019-90578482	0,263
Corsa 1,4	98=>	440/820	<b>01.1059</b>	669002-90522980	0,243

Cavo Frizione Autoregistrante - Selfadjusting Clutch Cables - à rattrapage Automatique - Samostavitelná spojková lanka - Саморегулируемые тросы сцепления  
Cavo Frizione Registrazione Manuale - Manual Adjusting Clutch Cable - à réglage manuel - Spojkové lanko staviteľné ručně - Тросы сцепления ручного регулирования

**CAVI FRIZIONE - CLUTCH CABLES - CABLES DE DEBRAYAGE  
KUPPLUNGSSEILE - CABLES EMBRAGUE - CABOS DE EMBRAIAGEM  
LINKI SPRZĘGŁA - SPOJKOVÁ LANKA - ТРОСЫ СЦЕПЛЕНИЯ**

				OEM REF.	
<b>OPEL</b>					
Agila 1,0-1,2	01=>	430/690	<b>01.0627</b>	4705606-4705607-9210082 9210079	0,202
Agila 1,2 16v mot. XE	04=>	413/675	<b>01.1133</b>	4707843-9216431	0,239
Agila 1,2 mot. XEP	04=>	355/627	<b>01.1226</b>	4707942-55555830	0,190
Agila 1,3 CTDI	04=>	355/660	<b>01.1227</b>	4707845-9216434	0,187
Agila all	08=>	435/720	<b>01.1256</b>	4709651-93195010-2371051K00	•
Kadett B	66=>	615/795	<b>01.191</b>	669021	0,361
Kadett C	73=>	760/960	<b>01.193</b>	669046	0,307
Kadett C (servo brake)	75=>	1035/1265	<b>01.329</b>	669049-669062	0,482
Kadett C	77=>	1070/1260	<b>01.520</b>	669061	0,445
Kadett D all	79=>	560/785	<b>01.525</b>	669088	0,338
Kadett D all	81=>	550/800	<b>01.521</b>	669124-90157009	0,341
Kadett E all	84=>	520/820	<b>01.158</b>	669142-90209335	0,265
Astra all	84=>	520/820	<b>01.158</b>	669142-90209335	0,265
Astra 1,4-1,8 8v (ch. 6000001-)	09/94=>	490/880	<b>01.0330</b>	669189-90522146	0,272
Astra 1,4-1,6-1,8-2,0 16v (ch. 6000001-)	09/94=>	490/900	<b>01.0195</b>	669003-669005-90522995 90523132	0,319
Tigra all	93=>	480/730	<b>01.0071</b>	669186-90446929	0,247
Tigra	09/96=>	410/795	<b>01.0193</b>	669187-90522447	0,230
Ascona B 1,3	79=>	1130/1420	<b>01.522</b>	669084-90086422	0,427
Ascona B 1,6-1,9	=>74	900/1115	<b>01.197</b>	669034	0,337
Ascona B 1,6-1,9	75=>	850/1060	<b>01.383</b>	669050-92777760	0,345
Ascona B 1,6-1,9-2,0 (8")	77=>	950/1190	<b>01.367</b>	669053-90280843	0,456
Ascona B 1,6-1,9-2,0	78=>	900/1200	<b>01.417</b>	669077-90092494	0,405
Ascona B 1,6-1,9-2,0	79=>	900/1200	<b>01.417</b>	669098-90147157	0,405
Ascona B D	78=>	1095/1370	<b>01.523</b>	669082	0,593
Ascona C-Ascona D	81=>	550/800	<b>01.521</b>	669124-90157009	0,341
Ascona C-Ascona D	83=>	560/795	<b>01.593</b>	669136-90193980	0,267
Manta 1,3	79=>	1130/1420	<b>01.522</b>	669084-90086422	0,427
Manta 1,6-1,9	=>74	900/1115	<b>01.197</b>	669034	0,337
Manta 1,6-1,9-2,0 (8")	77=>	950/1190	<b>01.367</b>	669053-90280843	0,456
Manta 1,6-1,9	75=>	850/1060	<b>01.383</b>	669050-92777760	0,345
Manta 1,6-1,9-2,0	78=>	900/1200	<b>01.417</b>	669077-90092494	0,405
Manta 1,6-1,9-2,0	79=>	900/1200	<b>01.417</b>	669098-90147157	0,405
Vectra all (exc.16v)	89=>	555/835	<b>01.039</b>	669161-669170	0,288
Vectra 16v-D	89=>	490/835	<b>01.040</b>	669166-90344249	0,711
Vectra 4x4	92=>95	495/785	<b>01.1060</b>	669179-90423340	•
Calibra	89=>	490/835	<b>01.040</b>	669166-90344249	0,711
Calibra 4x4	92=>95	495/785	<b>01.1060</b>	669179-90423340	•
Calibra all	95=>	450/895	<b>01.0329</b>	669194-90522460	0,648
Rekord C (8")	=>73	640/870	<b>01.203</b>	669031	0,330
Rekord C-D 1,7-1,9-2,0 (8")	74=>	785/955	<b>01.204</b>	669038	0,346

Cavo Frizione Autoregistrante - Selfadjusting Clutch Cables - à rattrapage Automatique - Samostaviteľná spojková lanka - Саморегулируемые тросы сцепления  
Cavo Frizione Registrazione Manuale - Manual Adjusting Clutch Cable - à réglage manuel - Spojkové lanko staviteľné ručně - Тросы сцепления ручного регулирования

**CAVI FRIZIONE - CLUTCH CABLES - CABLES DE DEBRAYAGE  
KUPPLUNGSSEILE - CABLES EMBRAGUE - CABOS DE EMBRAIAGEM  
LINKI SPRZĘGŁA - SPOJKOVÁ LANKA - ТРОСЫ СЦЕПЛЕНИЯ**

				<b>OEM REF.</b>	
---	---	---	--	-----------------	---

<b>OPEL</b>					
Rekord D 1,7-1,9-2,0 (9")	74=>	755/945	<b>01.246</b>	669042	0,330
Rekord D D	76=>	800/1050	<b>01.420</b>	669067-90086817	0,343
Rekord D D	78=>	800/1000	<b>01.452</b>	669073-90086966	0,456
Rekord E 1,7-1,9 (-ch. 100028)	78=>	720/985	<b>01.037</b>	669121-90147156-669075 90092615	0,305
Rekord E 1,7-2,0-2,2 (ch. 100029-)	80=>	750/1030	<b>01.038</b>	669096-90125946	0,367
Rekord E 1,8 (S-N)	83=>	800/1040	<b>01.349</b>	669130-90157384	0,336
Rekord E 2,2 (22E0028063)	83=>	750/1040	<b>01.766</b>	669146-90222211	0,361
Rekord E 1,7-2,0 D	79=>	750/1010	<b>01.418</b>	669071-90075823	0,522
Rekord E D (-ch. 0133688)	=>84	760/1030	<b>01.421</b>	669135-90182287	0,468
Rekord E D (ch. 0133689-)	85=>	785/1070	<b>01.208</b>	669140-90216224	0,498
Omega 1,8-2,0	08/86=>	800/1210	<b>01.215</b>	669149-90223402	0,394
Omega 1,8-2,0	87=>93	800/1250	<b>01.0072</b>	669159-90335385	0,385
Omega D 2,3-2,3 TD	86=>	800/1210	<b>01.216</b>	669154-90288756	0,267
Omega 3,0	88=>93	830/1270	<b>01.0073</b>	669168-90345232	0,502
Omega	86=>88	800/1210	<b>01.0331</b>	669151-90288231	0,503
Senator B 2,5 NE	86=>88	800/1210	<b>01.0331</b>	669151-90288231	0,503
Senator 3,0	88=>93	830/1270	<b>01.0073</b>	669168-90345232	0,502







<b>OPEL - Commercial Vehicle</b>					
Bedford CF (Perkins mot.)		1630/1810	<b>01.475</b>	2701364	0,583
Rascal all (-ch. YV609532)		1209/1588	<b>01.244</b>	91124889	0,615

<b>PEUGEOT</b>					
104 all	76=>	275/440	<b>01.326</b>	215039	0,149
104 all	80=>	280/455	<b>01.485</b>	215051	0,193
106 1,1 all	92=>	400/640	<b>01.251</b>	2150E0	0,234
106 1,4 all	92=>	1030/1275	<b>01.253</b>	2150C9	0,456
106 all (power steering)	92=>04/96	440/680	<b>01.0107</b>	2150E7	0,228
106 all (a/a)	96=>	1120/1350	<b>01.1075</b>	2150Q5	0,601
106 all (manual adjust)	96=>	1120/1350	<b>01.0334</b>	2150Q5	0,613
106 all (power steering) (a/a)	04/96=>	1237/1474	<b>01.1076</b>	2150Q6-96254125	0,638
106 all (power steering) (manual adjust)	96=>	1237/1474	<b>01.0335</b>	2150Q6-96254125	0,628
106 D	92=>04/96	510/670	<b>01.0180</b>	2150L8-2150Q3	0,446
107 1,0 all	05=>	1400/1565	<b>01.1123</b>	2150CQ	0,527
107 1,4 D all	05=>	1285/1450	<b>01.1124</b>	2150CR	0,478
205 all (gear BH3)	83=>	260/425	<b>01.555</b>	215059	0,164
205 all (gear BH3)	07/88=>	270/430	<b>01.756</b>	215094	0,172
205 1,1 (950) (gear MA-mot. TU)	=>07/88	420/615	<b>01.738</b>	215085	0,224





Cavo Frizione Autoregistrante - Selfadjusting Clutch Cables - à rattrapage Automatique - Samostavitelná spojková lanka - Саморегулируемые тросы сцепления  
Cavo Frizione Registrazione Manuale - Manual Adjusting Clutch Cable - à réglage manuel - Spojkové lanko staviteľné ručně - Тросы сцепления ручного регулирования

**CAVI FRIZIONE - CLUTCH CABLES - CABLES DE DEBRAYAGE  
KUPPLUNGSSEILE - CABLES EMBRAGUE - CABOS DE EMBRAIAGEM  
LINKI SPRZĘGŁA - SPOJKOVÁ LANKA - ТРОСЫ СЦЕПЛЕНИЯ**

				OEM REF.	
<b>PEUGEOT</b>					
205 1,1 (950) (gear MA)	07/88=>	430/620	<b>01.754</b>	215091	0,225
205 1,1 (950) Junior (gear MA)	07/89=>	435/620	<b>01.044</b>	2150A8	0,181
205 XS 1,3 (gear BH3)	=>07/88	1060/1270	<b>01.755</b>	215088	0,420
205 1,3 (gear MA)	07/88=>	1070/1270	<b>01.753</b>	215093	0,387
205 1,3 (gear MA)	07/89=>	1040/1270	<b>01.255</b>	2150C0	0,391
205 D all-205 GTI (gear BE1)	83=>	510/710	<b>01.165</b>	215065-215071	0,286
205 XA-XRA	87=>88	615/775	<b>01.166</b>	215060-215068	0,300
205 D all-205 GTI (gear BE1)	07/88=>	530/715	<b>01.757</b>	215096-215098	0,253
205 D-205 GTI (mot. XU) (gear BE3)	07/88=>89	380/640	<b>01.256</b>	2150A1	0,239
205 D-205 GTI (mot. XU) (gear BE3)	07/89=>	410/670	<b>01.261</b>	2150A6	0,219
206 all (gear MA) (a/a)	98=>	330/680	<b>01.1077</b>	2150X3-9652759680	0,350
206 all (gear MA) (manual adjust)	98=>	330/680	<b>01.0337</b>	2150X3	0,271
206 all (gear BE4) (a/a)	98=>	594/934	<b>01.1078</b>	2150X4	0,409
206 all-1,9 D (gear BE4) (manual adjust)	98=>	594/934	<b>01.0338</b>	2150X4	0,358
206 1,1-1,3-1,6 (ch. 9683-) (manual adjust)	00=>	350/570	<b>01.1154</b>	2150AX	0,245
206 1,1-1,3-1,6 (ch. 9683-) (a/a)	00=>	385/580	<b>01.1092</b>	2150AX	0,340
206 D Hdi 90 cv (ch. -9456)-206 2,0 16v GT (a/a)	00=>	645/915	<b>01.1079</b>	2150Y6	0,536
206 D Hdi 90 cv (-ch. 9456)/206 2,0 16V GT-Gti (manual adjust)	00=>	610/900	<b>01.0630</b>	2150Y6	0,508
206 D Hdi 90 cv (ch. 9457-) (manual adjust)	00=>	620/820	<b>01.1158</b>	2150AY-2150AZ	0,431
206 D Hdi 90 cv (ch. 9457-) (a/a)	00=>	645/833	<b>01.1074</b>	2150AY-2150AZ	0,539
206 2,0L 138 cv (ch. 9583-) (manual adjust)	00=>	620/820	<b>01.1158</b>	9633433280-9646323580	0,431
206 2,0L 138 cv (ch. 9583-) (a/a)	00=>	645/833	<b>01.1074</b>	9633433280-9646323580	0,539
206 all BZ (ch. 10556-) (a/a)	00=>	337/580	<b>01.1155</b>	2150CK	0,342
206 all BZ (ch. 10556-) (manual adjust)	00=>	345/575	<b>01.1247</b>	2150CK	0,249
206 all D Hdi (ch. 9583) (a/a)	00=>	597/828	<b>01.1156</b>	2150CH-9652759480	0,572
206 all 1,9 D (ch. 9583-) (manual adjust)	00=>	605/820	<b>01.1252</b>	2150CH-2150EE-9652759480 9686559480	•
206 all 1,9 D (ch. 9583-) (a/a)	02=>	640/820	<b>01.1251</b>	2150EG-9686559380	•
304 all	77=>06/82	730/1010	<b>01.385</b>	215045	0,282
305 all	77=>06/82	730/1010	<b>01.385</b>	215045	0,282
305 all (power steering)	07/82=>	565/720	<b>01.557</b>	215061	0,212
305 all	07/82=>	540/705	<b>01.556</b>	215057	0,193
306 all (gear MA) (1,4-1,6)	93=>	400/675	<b>01.631</b>	2150E9	0,251
306 all (gear BE3) (manual adjust)	93=>	330/655	<b>01.630</b>	2150E8-2150K3-2150G9-2150J1	0,526
306 all (mot. XU10JA) (gear BE3)	93=>	490/720	<b>01.0208</b>	2150F9-2150L6-2150K4	0,344
306 TD 1905cc (manual adjust)	94=>	500/750	<b>01.0336</b>	2150S2-2150X0-2150Y2	0,611
306 TD 1905cc (a/a)	94=>	513/725	<b>01.1228</b>	2150S2-2150X0-2150Y2 9632326780	0,692
306 all (mot. XU7JP) (gear BE3) (manual adjust)	93=>	314/667	<b>01.1093</b>	2150V9-9625276780	0,508
306 all (mot. XU7JP) (gear BE3) (a/a)	97=>	314/667	<b>01.1100</b>	2150V9	1,573
306 all 1,3-1,6 (gear MA) (manual adjust)	09/99=>	370/610	<b>01.1159</b>	2150Y7-9635749880	0,251
306 all 1,3-1,6 (gear MA) (a/a)	09/99=>	405/620	<b>01.1094</b>	2150Y7-9635749880	0,358
306 1,8-1,8 D-TD (-ch. 8336) SW TD (a/a)	=>00	366/655	<b>01.1095</b>	2150Y1-9634114380-2150L5 9622137780	0,631
306 D (mot. XUD7/9)-306 Hdi (ch. 8337-) (a/a)	00=>	368/626	<b>01.1080</b>	2150Y8-9634901780	0,616

Cavo Frizione Autoregistrante - Selfadjusting Clutch Cables - à rattrapage Automatique - Samostavitelná spojková lanka - Саморегулируемые тросы сцепления  
Cavo Frizione Registrazione Manuale - Manual Adjusting Clutch Cable - à réglage manuel - Spojkové lanko staviteľné ručně - Тросы сцепления ручного регулирования

**CAVI FRIZIONE - CLUTCH CABLES - CABLES DE DEBRAYAGE  
KUPPLUNGSSEILE - CABLES EMBRAGUE - CABOS DE EMBRAIAGEM  
LINKI SPRZĘGŁA - SPOJKOVÁ LANKA - ТРОСЫ СЦЕПЛЕНИЯ**

				OEM REF.	
<b>PEUGEOT</b>					
306 D (mot. XUD7/9)-306 Hdi (ch. 8337-) (manual adjust)	00=>	350/630	<b>01.0631</b>	2150Y8-9634901780	0,510
306 TD (mot. XUD97E) (manual adjust)	00=>	517/698	<b>01.0632</b>	2150Y9-9634729480	0,475
306 2,0 (mot. XU10J4 /S) (ch. 8337-) (manual adjust)	00=>	517/698	<b>01.0632</b>	2150Y9-9634729480	0,475
306 TD (mot. XUD97G) (a/a)	00=>	490/695	<b>01.1081</b>	2150Y9-9634729480	0,572
306 2,0 (mot. XU10J4 /S) (ch. 8337-) (a/a)	00=>	490/695	<b>01.1081</b>	2150Y9-9634729480	0,572
306 all (mot. XU10J4) (gear BE/3) (a/a)	93=>	510/720	<b>01.1157</b>	2150L6-2150K4	0,455
306 1,3-1,6 (gear MA) (manual adjust)	96=>99	475/642	<b>01.1184</b>	2150H1-9619147580	0,295
306 1,3-1,6 (gear MA) (a/a)	96=>99	365/642	<b>01.1160</b>	2150H1-9619147580	0,374
309 GL-Profil 1,1-1,3-E1-G1 (1118-1294cc)	85=>	615/775	<b>01.166</b>	215060-215068	0,300
309 GR-SR-GT (mot. XYU) (1580-1905cc)	85=>	510/710	<b>01.165</b>	215065-215071	0,286
309 GL 1,1-1,3 (1118-1294cc)	07/88=>	620/780	<b>01.759</b>	215089	0,264
309 (gear MA) (1124-1360cc)	07/88=>	1070/1270	<b>01.753</b>	215093	0,387
309 GR-SR-GT-D (1580/1905cc)	07/88=>	530/715	<b>01.757</b>	215096-215098	0,253
309 1,1-1,3 all (gear MA)	07/89=>	435/620	<b>01.044</b>	2150A8	0,181
309 1,6-1,9-GTI-D all (gear MA)	89=>	410/670	<b>01.261</b>	2150A6	0,219
405 GL 1,3 (6 cv)	88=>	1130/1335	<b>01.750</b>	215087-215083	0,433
405 all (exc.1,3) (-ch. 8102525)	88=>	545/750	<b>01.752</b>	215081	0,234
405 all (exc.1,3) (ch. 8102526-)	88=>	1130/1370	<b>01.751</b>	215079	0,487
405 all (exc.1,3-TD) (gear B3)	07/92=>12/92	1100/1355	<b>01.632</b>	2150E5	0,441
405 TD-M16	=>12/92	1120/1310	<b>01.633</b>	2150E3	0,542
405 (air cond.) (gear B3)	07/92=>12/92	1200/1455	<b>01.634</b>	2150F4-2150E4	0,482
405 1,6-1,8-2,0-1,9 D (a/a)	93=>	1185/1458	<b>01.1082</b>	2150G2-2150G5-96182662 0815705-6815081	0,647
405 1,6-1,8-2,0-1,9 D (manual adjust)	93=>	1200/1460	<b>01.0363</b>	2150G5-96182662-0815705 6815081-2150G2	0,668
405 TD-M16 (a/a)	93=>	1106/1323	<b>01.1106</b>	2150G3-96182664	0,638
405 TD-M16 (manual adjust)	93=>	1106/1323	<b>01.0209</b>	2150G3-96182664	0,609
406 all 1,6-1,8-1,8 16v (a/a)	96=>	406/811	<b>01.1107</b>	2150N1-2150W3-96192572	0,394
406 all 1,6-1,8-1,8 16v (manual adjust)	96=>	415/810	<b>01.0251</b>	2150N1-2150W3-96192572	0,307
406 all 2,0 16v-1,9 TD (a/a)	96=>	520/857	<b>01.1108</b>	2150N2-2150W4-96192573	0,443
406 all 2,0 16v-1,9TD (manual adjust)	96=>	540/855	<b>01.0250</b>	2150N2-2150W4-96192573	0,384
406 TD (XU95D) (gear BE3) (a/a)	98=>	390/811	<b>01.1109</b>	2150W5	0,615
406 TD (XU95D) (gear BE3) (manual adjust)	98=>	410/800	<b>01.0633</b>	2150W5	0,552
505 all	=>81	465/695	<b>01.492</b>	215050	0,195
505 all	82=>	465/790	<b>01.493</b>	215054-2150C5	0,219
605 BE3 (manual adjust)		516/826	<b>01.0635</b>	2150A3-2150CC	0,650
605 all (manual adjust)	=>90	486/783	<b>01.0634</b>	2150A4	0,630
806 BV-BE3-BE3R (a/a)	95=>	410/765	<b>01.1103</b>	2150S4-1476637080-1479128080	0,576
806 BV-BE3-BE3R (manual adjust)	95=>	360/760	<b>01.0078</b>	2150S4-1476637080-1479128080	0,536
806 2,0 TB-1,9 TD-BV ME (a/a)	95=>	550/855	<b>01.1104</b>	2150T1-1480346080-1476638080	0,661
806 2,0 TB-1,9 TD-BV ME (manual adjust)	95=>	515/855	<b>01.0079</b>	2150T1-1480346080-1476638080	0,555
806 2,1 TD BV ML (a/a)	96=>	765/1085	<b>01.1105</b>	2150P6-1476128080	0,472

Cavo Frizione Autoregistrante - Selfadjusting Clutch Cables - à rattrapage Automatique - Samostavitelná spojková lanka - Саморегулируемые тросы сцепления  
Cavo Frizione Registrazione Manuale - Manual Adjusting Clutch Cable - à réglage manuel - Spojkové lanko staviteľné ručne - Тросы сцепления ручного регулирования

**CAVI FRIZIONE - CLUTCH CABLES - CABLES DE DEBRAYAGE  
KUPPLUNGSSEILE - CABLES EMBRAGUE - CABOS DE EMBRAIAGEM  
LINKI SPRZĘGŁA - SPOJKOVÁ LANKA - ТРОСЫ СЦЕПЛЕНИЯ**

				<b>OEM REF.</b>	
---	---	---	--	-----------------	---

**PEUGEOT**

806 2,1 TD BV ML (manual adjust)	97=>	750/1095	<b>01.0356</b>	2150P6-1476128080	0,405
806 1,9 D-2,0 BE4R (a/a)	00=>	685/965	<b>01.1118</b>	2150AC-1487268080	0,556
806 1,9 D-2,0 BE4R (manual adjust)	00=>	655/965	<b>01.1146</b>	2150AC-1487268080	0,488
806 2,0 HDI BV ML5C (a/a)	00=>	695/995	<b>01.1119</b>	2150AN-1487725080	0,549
806 2,0 HDI BV ML5C (manual adjust)	00=>	660/1000	<b>01.1147</b>	2150AN	0,494



**PEUGEOT - Commercial Vehicle**





J5 all	81=>	920/1190	<b>01.451</b>	215055-2150E2	0,355
Partner all 1,4-1,6 (exc.1,8 D) (manual adjust)	97=>	340/635	<b>01.0325</b>	2150R1	0,264
Partner all 1,4-1,6 (exc.1,8 D) (a/a)	97=>	340/635	<b>01.1138</b>	2150R1	0,333
Partner 1,8 all (a/a)	97=>	310/650	<b>01.1085</b>	2150V1	0,365
Partner 1,8 all (manual adjust)	97=>	310/660	<b>01.0326</b>	2150V1	0,263
Partner DS all (manual adjust)	97=>	375/655	<b>01.1084</b>	2150R2	0,529
Partner all D (a/a)	97=>	366/653	<b>01.0651</b>	2150R2	0,634
Partner all 1,6 16v (a/a)	98=>	724/902	<b>01.0611</b>	2150AH	0,527
Partner all 1,6 16v (manual adjust)	98=>	700/895	<b>01.1135</b>	2150AH	0,502
Partner all (gear BE4) (a/a)	96=>99	705/870	<b>01.1183</b>	2150CY-9664708080	0,578
Partner all (gear BE4) (manual adjust)	03=>	700/895	<b>01.1139</b>	2150CF-9648780380R	0,500
Partner all (gear BE4R) (a/a)	03=>	724/902	<b>01.1083</b>	2150CF-2150CX-2150CS 9648780380-9661239180	0,559
Expert 1,6 D BV-BE3-BE3R (a/a)	95=>	410/765	<b>01.1103</b>	2150S4-1476637080-1479128080	0,576
Expert 1,6 D BV-BE3-BE3R (manual adjust)	95=>	360/760	<b>01.0078</b>	2150S4-1476637080-1479128080	0,536
Expert TD BV-ME (a/a)	95=>	550/855	<b>01.1104</b>	2150T1-1476638080	0,661
Expert TD BV-ME (manual adjust)	95=>	515/855	<b>01.0079</b>	2150T1-1476638080	0,555
Expert 2,1 TD BV-ML (a/a)	97=>	765/1085	<b>01.1105</b>	2150P6-1476128080	0,472
Expert 2,1 TD BV-ML (manual adjust)	97=>	750/1095	<b>01.0356</b>	2150P6-1476128080	0,405
Expert 1,9 D-2,0 BV BE4R (a/a)	00=>	685/965	<b>01.1118</b>	2150AC-1487268080	0,556
Expert 1,9 D-2,0 BV BE4R (manual adjust)	00=>	655/965	<b>01.1146</b>	2150AC-1487268080	0,488
Expert 2,0 HDI 95 cv BV-ML 5C (a/a)	00=>	695/995	<b>01.1119</b>	2150AN	0,549
Expert 2,0 HDI 95 cv BV-ML 5C (manual adjust)	00=>	660/1000	<b>01.1147</b>	2150AN	0,494
Boxer BV ME5T 2,0-D 1,9	94=>	540/1035	<b>01.0282</b>	2150J2-2150T4-2150T5 1310131080	0,289
Boxer BV ME5T TD 1,9	94=>	555/1090	<b>01.0284</b>	2150J4-2150T6-1312633080 1318446080	0,540
Boxer BV MG5T 2,0-D-TD-3,5T	94=>	520/1058	<b>01.0283</b>	2150J3-2150T7-1310132080	0,429
Boxer D 2,8	03=>	910/1435	<b>01.0618</b>	2150AV-1335052080	0,431
Boxer D 2,8	03=>	925/1480	<b>01.0372</b>	2150AP-1335053080 1321581080	0,730

**POLSKI**

126		330/2060	<b>01.103</b>	4285573	0,205
Polonez 1,3-1,5		920/1235	<b>01.465</b>	4355910	0,390

Cavo Frizione Autoregistrante - Selfadjusting Clutch Cables - à rattrapage Automatique - Samostavitelná spojková lanka - Саморегулируемые тросы сцепления  
Cavo Frizione Registrazione Manuale - Manual Adjusting Clutch Cable - à réglage manuel - Spojkové lanko staviteľné ručně - Тросы сцепления ручного регулирования

**CAVI FRIZIONE - CLUTCH CABLES - CABLES DE DEBRAYAGE  
KUPPLUNGSSEILE - CABLES EMBRAGUE - CABOS DE EMBRAIAGEM  
LINKI SPRZĘGŁA - SPOJKOVÁ LANKA - ТРОСЫ СЦЕПЛЕНИЯ**





				<b>OEM REF.</b>	
<b>POLSKI</b>					
Polonez UT		291/2077	<b>01.0264</b>	0230102	•
Polonez (II° s.)		950/1235	<b>01.0347</b>		•

<b>PORSCHE</b>					
914	69=>	880/2590	<b>01.0342</b>	91442340105	•
914/4		880/2580	<b>01.0339</b>	91442340200	•

<b>RENAULT</b>					
R4 L-TL (1120-21-22-23)	=>06/66	675/825	<b>01.053</b>	8546540	0,390
R4 L-TL (1120-21-22-23)	67=>72	705/800	<b>01.213</b>	7700553736	0,245
R4 L-TL	73=>	975/1060	<b>01.209</b>	7700560091-7704001996	0,293
R4 GTL	79=>	520/670	<b>01.310</b>	7704001778-7700620231	0,164
R4 GTL	=>10/82	550/715	<b>01.214</b>	7700553737	0,175
R5 L (1220-21) (dashboard gear)	72=>	795/970	<b>01.210</b>	7700539864	0,289
R5 L (1220-21)	73=>	500/690	<b>01.311</b>	7700637793-7700637783	0,219
R5 TL-TS (with shock absorber)	75=>79	480/630	<b>01.422</b>	7700585084	0,345
R5 TL-TS (1222-23-24-25) (without shock absorber)	=>79	480/630	<b>01.212</b>	7700653308-7700539862	0,185
R5 TL-TS-GTL (1222-23-24-25-27)/Alpine	80=>	480/610	<b>01.211</b>	7700643947-7700659964 7704001872	0,196
Supercinque	84=>	665/1085	<b>01.168</b>	7700761088	0,249
Supercinque	87=>	665/1085	<b>01.354</b>	7700783813-7700859233	0,538
Supercinque	95=>	650/1050	<b>01.0332</b>	6006004557	0,531
Twingo all	92=>	565/940	<b>01.273</b>	7700823050	0,223
Twingo all	98=>	565/930	<b>01.0300</b>	7700430111	0,220
Clio 1,1-1,2-1,4	90=>	645/1035	<b>01.200</b>	7700802682	0,540
Clio all	93=>	645/1035	<b>01.0210</b>	7700809961-7700832877	0,506
Clio 1,2-1,4-1,6-1,9 D	98=>	680/960	<b>01.0303</b>	7701421960-7700417050	0,712
Clio II 1,5 D	07/01=>	658/960	<b>01.1162</b>	8200098019	0,750
R6 (5cv)	67=>	705/800	<b>01.213</b>	7700553736	0,245
R6 (6cv)	70=>	550/715	<b>01.214</b>	7700553737	0,175
R6 (5cv)	73=>	975/1060	<b>01.209</b>	7700560091-7704001996	0,293
R9 all	=>81	620/1030	<b>01.481</b>	7704001506	0,229
R9 all	84=>	665/1085	<b>01.168</b>	7700761088	0,249
R9 all	87=>	665/1085	<b>01.354</b>	7700783813-7700859233	0,538
R11 all	=>81	620/1030	<b>01.481</b>	7704001506	0,229
R11 all	84=>	665/1085	<b>01.168</b>	7700761088	0,249
R11 all	87=>	665/1085	<b>01.354</b>	7700783813-7700859233	0,538
R12 L-TL (1170) (1330)	=>10/72	590/750	<b>01.217</b>	7701348555	0,204
R12 TS	=>72	710/865	<b>01.218</b>	7701454202-7700568945	0,501
R12 L-TL-TS (1179-1337-1338-2360)	75=>	635/785	<b>01.314</b>	7701348399-7700577706	0,235
R12 L-TL (1170)	75	550/710	<b>01.054</b>	7701457093	0,196

Cavo Frizione Autoregistrante - Selfadjusting Clutch Cables - à rattrapage Automatique - Samostavitelná spojková lanka - Саморегулируемые тросы сцепления  
Cavo Frizione Registrazione Manuale - Manual Adjusting Clutch Cable - à réglage manuel - Spojkové lanko staviteľné ručně - Тросы сцепления ручного регулирования

**CAVI FRIZIONE - CLUTCH CABLES - CABLES DE DEBRAYAGE  
KUPPLUNGSSEILE - CABLES EMBRAGUE - CABOS DE EMBRAIAGEM  
LINKI SPRZĘGŁA - SPOJKOVÁ LANKA - ТРОСЫ СЦЕПЛЕНИЯ**

				OEM REF.	
<b>RENAULT</b>					
R14 all (1210-1211)	76=>	400/620	<b>01.315</b>	7701348493	0,235
R15 TL-GTL (1300)	=>06/74	710/865	<b>01.218</b>	7701454202-7700568945	0,501
R15 TL-GTL (1300)	06/74=>	635/785	<b>01.314</b>	7701348399-7700577706	0,235
R16 all (1150cc)	=>68	360/540	<b>01.051</b>	09842538-09842613-7700500419	0,168
R16 all	69=>	380/560	<b>01.220</b>	7700547794	0,162
R18 TL-GTL	=>10/79	860/1065	<b>01.424</b>	7700636494	0,578
R18 TS-GTS	=>79	1315/1520	<b>01.425</b>	7700636493-7700665849	0,445
R18 TL-GTL (1340-1350-1360-2350)	80=>	865/1075	<b>01.459</b>	7701349128-7704002279	0,318
R18 TS-GTS (1358-1380)	80=>	1320/1525	<b>01.460</b>	7701349971-7704002282	0,461
R18 T (1345)	=>81	725/950	<b>01.545</b>	7701349129	0,268
R18 TX-GTX-TD-GTD	81=>	830/1030	<b>01.546</b>	7704002286-7700688586	0,659
R18 TX-GTX-TD-GTD (1366)	83=>	800/1000	<b>01.169</b>	7700761516	0,625
R18 GTS-T-Break	81=>	1235/1470	<b>01.052</b>	7700696229-7704002290	0,425
Fuego TL-GTL (1360)	80=>	865/1075	<b>01.459</b>	7701349128-7704002279	0,318
Fuego GTI-GTS (1358-1380)	80=>	1320/1525	<b>01.460</b>	7701349971-7704002282	0,461
Fuego GTX-TD	81=>	830/1030	<b>01.546</b>	7704002286-7700688586	0,659
Fuego GTS-T (USA model)	81=>	1235/1470	<b>01.052</b>	7700696229-7704002290	0,425
Fuego (1366)	83=>	800/1000	<b>01.169</b>	7700761516	0,625
Fuego (with power steering)		1210/1465	<b>01.0196</b>	7700672614	0,438
R19 all	88=>	620/1045	<b>01.357</b>	7700787470-7700811013	0,225
R19 all	95=>	610/1010	<b>01.0636</b>	7700834725	0,239
R20 TS (1272)-D	=>80	1110/1310	<b>01.560</b>	7700672631	0,594
R20 TS (1277)-D	81=>	1110/1310	<b>01.561</b>	7700678753-7704001240	0,625
R21 TL-TS-GTS-RS-TSE (Cat.) (481)	86=>	880/1140	<b>01.219</b>	7700756971	0,324
R21 TL-TS-GTS-RS-TSE (Cat.) (481)	88=>	885/1140	<b>01.359</b>	7700781858-7700803913	0,659
R21 TXE-RX/Nevada/Medallion (USA)	88=>	890/1230	<b>01.362</b>	7700763190	0,428
R21 TD-TDX-GTD (486/48v)	86=>	1130/1400	<b>01.224</b>	7700763191	0,641
R21 TXE-RX-Nevada TD-DX (L483/48Y-488) Medallion (USA)	86=>	875/1120	<b>01.221</b>	7700769247	0,615
R21 TD-TDX-Nevada (488)	05/89=>	900/1225	<b>01.0113</b>	7700799501	0,695
Laguna all (exc.3,0 V6) (a/a)	94=>	890/1250	<b>01.1068</b>	7700413205-7700413206	0,870
Laguna all (exc.3,0 V6)	94=>	880/1248	<b>01.1248</b>	7700413205-7700413206	•
Laguna all (exc.3,0 V6) (manual adjust)	94=>	890/1250	<b>01.0211</b>	7700840014-7700847976	0,551
Laguna 3,0 V6 (a/a)	94=>	730/1150	<b>01.1069</b>	7700432383	1,039
Laguna 3,0 V6 (manual adjust)	94=>	730/1150	<b>01.0212</b>	7700840097-7700428748	0,861
Laguna 1,9 Dti (a/a)	94=>	865/1197	<b>01.1117</b>	8200018668	1,152
Laguna 1,9 Dti (manual adjust)	94=>	865/1197	<b>01.0637</b>	8200018668	1,066
Laguna all (exc. 3,0 V6) (manual adjust)	94=>98	900/1130	<b>01.1254</b>	7700432383	•
Laguna all (exc.2,0-1,9 Dti-3,0 V6) (a/a)	98=>	870/1196	<b>01.1163</b>	7700431360	0,740
Laguna I 1,9 Dci/Dti (a/a)	07/98=>	900/1245	<b>01.1253</b>	7700421415	•

Cavo Frizione Autoregistrante - Selfadjusting Clutch Cables - à rattrapage Automatique - Samostavitelná spojková lanka - Саморегулируемые тросы сцепления  
Cavo Frizione Registrazione Manuale - Manual Adjusting Clutch Cable - à réglage manuel - Spojkové lanko staviteľné ručně - Тросы сцепления ручного регулирования

**CAVI FRIZIONE - CLUTCH CABLES - CABLES DE DEBRAYAGE  
KUPPLUNGSSEILE - CABLES EMBRAGUE - CABOS DE EMBRAIAGEM  
LINKI SPRZĘGŁA - SPOJKOVÁ LANKA - ТРОСЫ СЦЕПЛЕНИЯ**

				OEM REF.	
<b>RENAULT</b>					
Megane 1,4-1,6/Coach/Scenic	09/95=>	615/970	<b>01.0197</b>	7700843206-7700429330	0,699
Megane 2,0 16v/Coach 2,0 16v (exc.Dti)	09/95=>	615/970	<b>01.0198</b>	7700843188	0,709
Megane/Scenic Dti	97=>	615/970	<b>01.0305</b>	7700423684-8200073170	0,748
R25 TS-GTS	84=>	1140/1320	<b>01.183</b>	7700757740	0,679
R25 all	89=>	1120/1345	<b>01.620</b>	7700795943 7700804476	0,766
R30 TD	81=>	1110/1310	<b>01.561</b>	7700678753-7704001240	0,625
Safrane all (manual adjust)	11/92=>	920/1295	<b>01.0214</b>	7700813657-7700827853	0,888
Espace all	84=>	445/715	<b>01.477</b>	6025002833-6025002522	0,216
Espace D all	84=>	445/715	<b>01.399</b>	6025002832	0,261
Espace all	91=>	1100/1300	<b>01.281</b>	6025103091-6025170727	0,470
Espace D all	91=>	1100/1295	<b>01.290</b>	6025103090-6025170728	0,748
Espace D all (manual adjust)	12/95=>	1130/1320	<b>01.0333</b>	6025171255	0,500
Espace III (a/a)	91=>96	1132/1318	<b>01.1130</b>	6025171256	0,504
Espace III (a/a)	97=>02	858/1072	<b>01.1131</b>	6025304915	0,602
Espace III all (manual adjust)	97=>02	855/1070	<b>01.1255</b>	6025304915	•
Espace III 1,9 Dti Multispace	08/00=>08/01	900/1075	<b>01.1249</b>	6025312553	•
 					
<b>RENAULT - Commercial Vehicle</b>					
R4 F4 Cargo (2106-2109)	67=>72	705/800	<b>01.213</b>	7700553736	0,245
R4 F4 Cargo (2106-2109-2391-2392)	73=>	975/1060	<b>01.209</b>	7700560091-7704001996	0,293
R4 F6 Cargo (2370-2430)	79=>	520/670	<b>01.310</b>	7704001778-7700620231	0,164
R4 F6 Cargo (2370-2430)	=>10/82	550/715	<b>01.214</b>	7700553737	0,175
Kangoo all 1,2-1,4-1,9 D	97=>	680/960	<b>01.0303</b>	7700417050	0,712
Kangoo all 1,5 D	06/01=>	658/960	<b>01.1162</b>	8200098019	0,750
Express	84=>	730/1150	<b>01.168</b>	7700761088	0,249
Express	08/91=>94	665/1085	<b>01.354</b>	7700783813-7700859233	0,538
Express	95=>	650/1050	<b>01.0332</b>	6006004557	0,531
Estafette all (2137)	72=>	510/780	<b>01.563</b>	7700548640	0,198
Trafic PR/AR 1,4-1,7 BZ (847) TP 3-5-6-8	81=>	490/750	<b>01.564</b>	7700690096	0,168
Trafic TR/AV 1,4-1,7 BZ (TO 847-T8 FN1)TA1-3-4-5	81=>	470/720	<b>01.225</b>	7700690094	0,208
Trafic TR/AV 1,4-1,7 BZ	11/87=>	480/725	<b>01.292</b>	7700743104	0,202
Trafic TR/AV 2,0 BZ-2,1 D	88=>	1100/1400	<b>01.047</b>	7700747426-7700736293	0,400
Trafic PR/AR (841) 1,7 BZ	81=>	680/1140	<b>01.619</b>	7700690097	0,218
Trafic TR/AV 2,4-2,5 (4x4)	90=>	1050/1270	<b>01.298</b>	7700744556	0,390
Trafic PR/AR 2,0 BZ-2,1 D	90=>	1110/1365	<b>01.301</b>	7700738424	0,346
Trafic PR/AR 1,9 D	97=>	840/1284	<b>01.0638</b>	7700310086	0,364

Cavo Frizione Autoregistrante - Selfadjusting Clutch Cables - à rattrapage Automatique - Samostavitelná spojková lanka - Саморегулируемые тросы сцепления  
Cavo Frizione Registrazione Manuale - Manual Adjusting Clutch Cable - à réglage manuel - Spojkové lanko staviteľné ručně - Тросы сцепления ручного регулирования

**CAVI FRIZIONE - CLUTCH CABLES - CABLES DE DEBRAYAGE  
KUPPLUNGSSEILE - CABLES EMBRAGUE - CABOS DE EMBRAIAGEM  
LINKI SPRZĘGŁA - SPOJKOVÁ LANKA - ТРОСЫ СЦЕПЛЕНИЯ**

				<b>OEM REF.</b>	
---	---	---	--	-----------------	---

**RENAULT - Commercial Vehicle**

Master TA (4 speed)	81=>	1040/1260	<b>01.744</b>	5000390299	0,397
Master TP	81=>	1650/1930	<b>01.743</b>	5000390303	0,601
Master TR-AV (4 speed)	=>82	1040/1300	<b>01.0243</b>	5000390326	0,401
Master TR-AV (5 speed)	82=>	1150/1400	<b>01.048</b>	5000395159	0,732
Master TR-AV T (5 speed)	89=>	1180/1360	<b>01.049</b>	7700745352-6006000873	0,712
Master PR/AR (8903-)	89=>97	1737/1980	<b>01.0244</b>	7700745354	0,680
SG2-SG4 BZ		710/1285	<b>01.369</b>	8546097	0,286
SG2-SG4 D	=>06/80	550/1285	<b>01.352</b>	5000002223-5000515126	0,246

**RENAULT - DACIA**

Logan all BZ-D	04=>	690/1135	<b>01.1161</b>	6001546867-8200215961	0,352
----------------	------	----------	----------------	-----------------------	-------

**ROVER**

Metro	84=>92	1080/1130	<b>01.242</b>	GVC5021	0,503
Metro 100-D 1,4-1,5 all (manual adjust)	92=>	572/835	<b>01.0215</b>	GVC5056	•
Maestro	83=>84	950/1190	<b>01.243</b>	ADU6205	0,368
213 1,3 all (manual adjust)	84=>12/89	1137/1577	<b>01.0364</b>	GVC5005	0,655
214-414 all (manual adjust)	10/89=>	480/735	<b>01.0216</b>	GVC5044	0,332
216 1,6 all (manual adjust)	84=>09/89	728/947	<b>01.0365</b>	GVC5003	0,454
216-416 GSI	89=>	1280/1415	<b>01.0217</b>	GVC5030-GVC5039	0,601
216-416 all	89=>	1300/1440	<b>01.0218</b>	GVC5053	0,546
220-420 all (-ch. 231761)	89=>	1300/1440	<b>01.0218</b>	GVC5053	0,546
220-420 all (-ch. 231762) (manual adjust)	92=>	610/875	<b>01.0219</b>	GVC5050	0,400

**SAAB**





900 all 4 cyl. (manual adjust)	94=>	479/812	<b>01.0220</b>	4490181-4901724	0,267
900 all 6 cyl. (manual adjust)	94=>	479/812	<b>01.0220</b>	4490199	0,267

**SEAT**

Marbella (4 speed)	=>89	300/515	<b>01.397</b>	SE141126201A	0,126
Marbella (5 speed)	=>89	410/565	<b>01.184</b>	SE141126201B	0,146
127	=>08/75	290/440	<b>01.124</b>	HB12623100	0,138
127	09/75=>	285/465	<b>01.260</b>	HB12623101	0,143
127 L-CL	78=>	300/480	<b>01.258</b>	HH12623104	0,116
127 Fura	84=>	343/505	<b>01.495</b>	X039339470	0,129
Arosa w/ESP (manual adjust)	03/01=>	833/1073	<b>01.0639</b>	6N1721335K	0,529
Arosa 1,0 (a/a)	98=>	833/1073	<b>01.1110</b>	6N1721335D-6N1721335J 6X1721335	0,721
Ritmo 60		410/630	<b>01.320</b>	RF12620102	0,150
Ritmo 65 (servo brake)	=>81	380/630	<b>01.432</b>	X044453260	0,176

Cavo Frizione Autoregistrante - Selfadjusting Clutch Cables - à rattrapage Automatique - Samostavitelná spojková lanka - Саморегулируемые тросы сцепления  
Cavo Frizione Registrazione Manuale - Manual Adjusting Clutch Cable - à réglage manuel - Spojkové lanko staviteľné ručně - Тросы сцепления ручного регулирования

**CAVI FRIZIONE - CLUTCH CABLES - CABLES DE DEBRAYAGE  
KUPPLUNGSSEILE - CABLES EMBRAGUE - CABOS DE EMBRAIAGEM  
LINKI SPRZĘGŁA - SPOJKOVÁ LANKA - ТРОСЫ СЦЕПЛЕНИЯ**

				OEM REF.	
<b>SEAT</b>					
Ritmo D	=>05/81	330/575	<b>01.441</b>	X044319920	0,160
Ritmo	=>83	390/625	<b>01.453</b>	X059368380	0,136
Ritmo D	03/83=>	330/580	<b>01.449</b>	X059371150	0,125
Ronda 1,2-1,5	=>03/83	390/625	<b>01.453</b>	X059368380	0,136
Ronda D	03/83=>	330/580	<b>01.449</b>	X059371150	0,125
Ronda all (exc.D)	83=>86	390/640	<b>01.135</b>	SE022126201-3943010	0,139
Ronda all (exc.D)	87=>	365/620	<b>01.607</b>	SE022126201A-39553500	0,169
Ronda D	87=>	330/580	<b>01.608</b>	SE138126201A-39553510	0,148
Ibiza Junior (903cc)	87=>91	300/590	<b>01.376</b>	SE021126201	0,128
Ibiza Junior (903cc)	91=>92	300/600	<b>01.601</b>	SE021126201A	0,159
Ibiza all (exc.D)	83=>86	390/640	<b>01.135</b>	SE022126201-3943010	0,139
Ibiza all (exc.D)	87=>	365/620	<b>01.607</b>	SE022126201A-39553500	0,169
Ibiza D	03/83=>	330/580	<b>01.449</b>	X059371150	0,125
Ibiza D	87=>	330/580	<b>01.608</b>	SE138126201A-39553510	0,148
Ibiza 1,4-1,6 (manual adjust)	93=>94	823/1097	<b>01.0221</b>	6K1721335A	0,372
Ibiza 1,4-1,6 (a/a)	93=>94	823/1097	<b>01.1111</b>	6K1721335A	0,434
Ibiza 1,4-1,6	95=>	804/1065	<b>01.0222</b>	6K1721335G-6K1721335H	0,338
Ibiza 1050cc-1,4	09/96=>	804/1065	<b>01.0222</b>	6K1721335G-6K1721335H	0,338
Ibiza 1,4 all	99=>	804/1065	<b>01.0222</b>	6K1721335G-6K1721335H	0,338
Ibiza 1,6-1,8 (a/a)	93=>	630/830	<b>01.0224</b>	6K1721335B	0,380
Ibiza 1,6-1,8-D (manual adjust)	93=>	598/865	<b>01.0313</b>	6K1721335B-6K1721335C	0,294
Ibiza D (a/a)	93=>	640/860	<b>01.0225</b>	6K1721335C	0,390
Ibiza 1,6-1,8-TD 90CV (manual adjust)	09/96=>	973/1333	<b>01.0354</b>	6K1721335L	0,470
Ibiza 1,6-1,8-TD 90CV (a/a)	09/96=>	985/1300	<b>01.1112</b>	6K1721335L	0,489
Ibiza 1,6-1,8-TD term. T (manual adjust)	09/97=>	1016/1350	<b>01.0640</b>	6K1721335J	0,459
Ibiza 1,6-1,8-TD term. T (a/a)	09/97=>	1028/1340	<b>01.1113</b>	6K1721335J	0,609
Ibiza 1,4-1,6	99=>	715/985	<b>01.0645</b>	6K1721335Q-6K1721335T 6K1721335AA	0,276
Cordoba 1,4-1,6 all	95=>	804/1065	<b>01.0222</b>	6K1721335G-6K1721335H	0,338
Cordoba 1,4	09/96=>	804/1065	<b>01.0222</b>	6K1721335G-6K1721335H	0,338
Cordoba 1,4 all	99=>	804/1065	<b>01.0222</b>	6K1721335G-6K1721335H	0,338
Cordoba 1,6-1,8 (a/a)	93=>	630/830	<b>01.0224</b>	6K1721335B	0,380
Cordoba 1,6-1,8-D (manual adjust)	93=>	598/865	<b>01.0313</b>	6K1721335B-6K1721335C	0,294
Cordoba D (a/a)	93=>	640/860	<b>01.0225</b>	6K1721335C	0,390
Cordoba 1,4-1,6 (manual adjust)	93=>94	823/1097	<b>01.0221</b>	6K1721335A	0,372
Cordoba 1,4-1,6 (a/a)	93=>94	823/1097	<b>01.1111</b>	6K1721335A	0,434
Cordoba 1,6-1,8-TD 90CV (manual adjust)	09/96=>	973/1333	<b>01.0354</b>	6K1721335L	0,470
Cordoba 1,6-1,8-TD 90CV (a/a)	09/96=>	985/1300	<b>01.1112</b>	6K1721335L	0,489
Cordoba 1,6-1,8-TD term. T (manual adjust)	09/97=>	1016/1350	<b>01.0640</b>	6K1721335J	0,459
Cordoba 1,6-1,8-TD term. T (a/a)	09/97=>	1028/1340	<b>01.1113</b>	6K1721335J	0,609
Cordoba 1,4-1,6	99=>	715/985	<b>01.0645</b>	6K1721335Q-6K1721335T 6K1721335AA	0,276
Malaga BZ	=>90	340/620	<b>01.0226</b>	X03970398	0,130
Malaga BZ	90=>	730/1100	<b>01.377</b>	SE023126201A	0,274
Malaga D	90=>	620/900	<b>01.378</b>	SE023126201B	0,245
Malaga all (exc.D)	83=>86	390/640	<b>01.135</b>	SE022126201-3943010	0,139

Cavo Frizione Autoregistrante - Selfadjusting Clutch Cables - à rattrapage Automatique - Samostavitelná spojková lanka - Саморегулируемые тросы сцепления  
Cavo Frizione Registrazione Manuale - Manual Adjusting Clutch Cable - à réglage manuel - Spojkové lanko stavitelné ručně - Тросы сцепления ручного регулирования

**CAVI FRIZIONE - CLUTCH CABLES - CABLES DE DEBRAYAGE  
KUPPLUNGSSEILE - CABLES EMBRAGUE - CABOS DE EMBRAIAGEM  
LINKI SPRZĘGŁA - SPOJKOVÁ LANKA - ТРОСЫ СЦЕПЛЕНИЯ**

				<b>OEM REF.</b>	
---	---	---	--	-----------------	---

<b>SEAT</b>					
Malaga all (exc.D)	87=>	365/620	<b>01.607</b>	SE022126201A-39553500	0,169
Malaga D	87=>	330/580	<b>01.608</b>	SE138126201A-39553510	0,148
124 all		760/960	<b>01.116</b>	FA12623103	0,283
131 (1430-1600)	=>02/78	1010/1220	<b>01.129</b>	JA12620100	0,424
131 (1430-1600)	03/78=>	1010/1225	<b>01.450</b>	JA12620101	0,441
Toledo all (a/a)	92=>	530/800	<b>01.382</b>	191721335AB	0,425
Toledo all (manual adjust)	92=>	520/830	<b>01.0307</b>	191721335AB	0,324
132 all	=>07/77	885/1100	<b>01.122</b>	GE12623100	0,320







<b>SEAT - Commercial Vehicle</b>					
Terra (4 speed)	=>89	310/520	<b>01.397</b>	SE141126201A	0,126
Terra (5 speed)	=>89	410/565	<b>01.184</b>	SE141126201B	0,146
Terra all 1,3-1,4-D (5 speed)	90=>	350/580	<b>01.371</b>	X03961680-SE029110699A	0,164
Terra all (4 speed)	90=>	310/527	<b>01.0366</b>	SE029110699C	0,127
Inca BZ all	95=>96	804/1065	<b>01.0222</b>	6K1721335G-6K1721335H	0,338
Inca D all (manual adjust)	95=>96	598/865	<b>01.0313</b>	6K1721335B-6K1721335C	0,294
Inca mot. AKK+LD+UC+NV+NW	99=>02	715/985	<b>01.0645</b>	6K1721335Q-6K1721335T 6K1721335AA	0,276

<b>SKODA</b>					
Felicia D all		520/745	<b>01.0316</b>	6U2721335D	0,230
Felicia BZ all		520/745	<b>01.1164</b>	6U0721335	0,255
Favorit all	88=>	370/595	<b>01.0641</b>	6UD721335-115522744	0,235

<b>SUBARU</b>					
Justy all	89=>	1060/1165	<b>01.0228</b>	737026301-737026302	0,430
DL/GL 2D-3D-4D-SW 1,4-1,6	=>79	430/605	<b>01.0049</b>	637120163-637120164	0,300
DL 2D-3D-4D/hatch 1,6 (exc.SW)	80=>83	470/605	<b>01.0040</b>	737026011	0,577
DL/GL SW 1,6-1,8	80=>83	730/880	<b>01.0041</b>	737026032	0,393
DL 1,3-1,6-1,8	84=>	670/845	<b>01.0042</b>	37026GA081	0,349
DL/GL 1,8 4WD T	85=>89	670/845	<b>01.0042</b>	37026GA081	0,349
DL/GL 1,8 4WD	84=>89	720/900	<b>01.0043</b>	737026033	•
GL 1800 2WD	85=>88	770/915	<b>01.0045</b>	37026GA100	0,341
Impreza 1,8-2,0	93=>	580/775	<b>01.0229</b>	37214AA030	0,336
XT all (exc.T)	85=>88	770/945	<b>01.0046</b>	37026GA200	0,335

Cavo Frizione Autoregistrante - Selfadjusting Clutch Cables - à rattrapage Automatique - Samostavitelná spojková lanka - Саморегулируемые тросы сцепления  
Cavo Frizione Registrazione Manuale - Manual Adjusting Clutch Cable - à réglage manuel - Spojkové lanko staviteľné ručně - Тросы сцепления ручного регулирования

**CAVI FRIZIONE - CLUTCH CABLES - CABLES DE DEBRAYAGE  
KUPPLUNGSSEILE - CABLES EMBRAGUE - CABOS DE EMBRAIAGEM  
LINKI SPRZĘGŁA - SPOJKOVÁ LANKA - ТРОСЫ СЦЕПЛЕНИЯ**

				OEM REF.	
<b>SUBARU</b>					
XT all (exc.T)	89=>	770/915	<b>01.0045</b>	37026GA100	0,341
XT T	85=>88	650/855	<b>01.0048</b>	37026GA310	0,331
XT 6 all	88=>	650/855	<b>01.0048</b>	37026GA310	0,331
XT T	89=>	670/845	<b>01.0042</b>	37026GA081	0,349

<b>SUZUKI</b>					
Alto all	85=>	290/525	<b>01.0050</b>	2371078162	0,159
Alto all	89=>	240/525	<b>01.0199</b>	2371078164	0,192
Alto all	94=>	350/560	<b>01.1229</b>	23710M72F30	0,231
Alto all	09=>	420/665	<b>01.1218</b>	23710M68K01	•
Swift all	89=>	395/555	<b>01.0051</b>	2371063B10-2371063B11	0,192
Swift all	95=>	395/570	<b>01.0351</b>	2371050GB01	0,202
Splash all	08=>	435/720	<b>01.1256</b>	4709651-93195010-2371051K00	•
Ignis 1,3 all	02=>	390/655	<b>01.1230</b>	2371086G00	0,199
Ignis D	02=>	380/685	<b>01.1231</b>	2371086G80	0,280
Jimny	00=>	1767/1925	<b>01.1245</b>	2371081A61	0,663
Santana SJ 410	84=>	1370/1670	<b>01.0052</b>	2371080420	0,505
Santana SJ 413	85=>	1550/1875	<b>01.0053</b>	2371083023-2371083024	0,628
Vitara 1,3 all	89=>	1530/1840	<b>01.0054</b>	2371063A10-2371063A11 2371060B00	0,632
Vitara 1,6	89=>	1610/1850	<b>01.0230</b>	2371057B10-2371057B11 2371057B12-2371060A10 2371060A11-2371060AA0 237108C60	0,548
Baleno	95=>	400/630	<b>01.0260</b>	2371060G20-2371060G21	0,231
Wagon R all	99=>	413/675	<b>01.1133</b>	2371083E41	0,239

<b>TALBOT</b>					
Samba all	82=>	280/455	<b>01.665</b>	9150101780	0,193





<b>TOYOTA</b>					
Aygo 1,0 all	05=>	1400/1564	<b>01.1123</b>	2150CQ	0,527
Aygo 1,4 Hdi	05=>	1285/1450	<b>01.1124</b>	2150CR	0,478
Starlet	78=>82	690/1600	<b>01.0057</b>	3134019196-3134019197	0,310
Starlet	82=>	700/1670	<b>01.0058</b>	3134019245-3134019275	0,351
Corolla KE 20	70=>74	775/1740	<b>01.536</b>	3134019125	0,311
Corolla KE 70	80=>	755/1715	<b>01.0059</b>	3134019225	0,405
Tercel AL 11	08/82=>	695/975	<b>01.539</b>	3134016110	0,316
Tercel AL 20	82=>	650/905	<b>01.0062</b>	3134016130	0,369

Cavo Frizione Autoregistrante - Selfadjusting Clutch Cables - à rattrapage Automatique - Samostavitelná spojková lanka - Саморегулируемые тросы сцепления  
Cavo Frizione Registrazione Manuale - Manual Adjusting Clutch Cable - à réglage manuel - Spojkové lanko staviteľné ručně - Тросы сцепления ручного регулирования





# ERRATA CORRIGE

## page. 27

**CAVI FRIZIONE - CLUTCH CABLES - CABLES DE DEBRAYAGE  
KUPPLUNGSSEILE - CABLES EMBRAGUE - CABOS DE EMBRAIAGEM  
LINKI SPRZĘGŁA - SPOJKOVÁ LANKA - ТРОСЫ СЦЕПЛЕНИЯ**

				OEM REF.	
<b>SUZUKI</b>					
Vitara 1,6 (exc. 16v)	89=>	1650/1870	<b>01.0230</b>	2371060A10-2371060A11 2371060AA0	0,548
Vitara 1,6 16v	89=>	1615/1870	<b>01.0367</b>	2371057B10-2371057B11 2371057B12-237108C60	0,548

**CAVI FRIZIONE - CLUTCH CABLES - CABLES DE DEBRAYAGE  
KUPPLUNGSSEILE - CABLES EMBRAGUE - CABOS DE EMBRAIAGEM  
LINKI SPRZĘGŁA - SPOJKOVÁ LANKA - ТРОСЫ СЦЕПЛЕНИЯ**

				<b>OEM REF.</b>	
<b>TOYOTA</b>					
Lite Ace Van 1,3	80=>85	2230/2485	<b>01.0063</b>	3134029085	•

<b>VOLKSWAGEN</b>					
Polo/Derby	74=>	375/595	<b>01.670</b>	867721335C-861721335A	0,181
Polo/Derby all	87=>	340/620	<b>01.363</b>	867721335E	0,181
Polo Classic all (a/a)	93=>	789/1041	<b>01.1115</b>	6N1721335B	0,614
Polo Classic all (manual adjust)	94=>	790/1040	<b>01.0314</b>	6N1721335B	0,565
Polo all (a/a)	09/94=>	833/1073	<b>01.1110</b>	6X1721335-6N1721335	0,721
Polo (manual adjust)	09/94=>	820/1110	<b>01.0315</b>	6N1721335-6X1721335	0,532
Lupo (manual adjust)	09/94=>	820/1110	<b>01.0315</b>	6N1721335-6X1721335	0,532
Lupo all (a/a)		865/1050	<b>01.0044</b>	6N1721335K	0,721
Lupo all (a/a)	09/94=>	833/1073	<b>01.1110</b>	6X1721335-6N1721335	0,721
1200 Beetle	=>60	2265	<b>01.982</b>	111721335	0,161
1200/1300 Beetle	61=>	2270	<b>01.227</b>	113721335A	0,145
1200/1300/1600 Beetle	72=>	2290	<b>01.228</b>	111721335C	0,148
1200/1300/1600 Beetle	73=>	2280	<b>01.440</b>	111721335D	0,139
1300/1600 Beetle	74=>	2280	<b>01.331</b>	111721335E	0,161
1300/1600 Beetle	74=>	2270	<b>01.227</b>	113721335-113721335A 113721335C	0,145
1500 (type 3)/1600 (type 3)/Variant/Ghia	61=>	2330	<b>01.230</b>	311721335A-311721335	0,137
Golf Rabbit all	=>74	615/855	<b>01.291</b>	171721335B	0,238
Golf Rabbit all	74=>	840/1070	<b>01.234</b>	171721335C	0,307
Golf Rabbit 1,1-1,3-1,5	76=>	845/1060	<b>01.427</b>	171721335D	0,323
Golf GTI-D-TD	76=>	580/810	<b>01.297</b>	171721335E	0,227
Golf 1,1-1,3-1,5/Jetta 1,3	09/83=>	825/1100	<b>01.527</b>	191721335	0,306
Golf D/Jetta D	09/83=>	545/810	<b>01.528</b>	191721335A	0,214
Golf 1,6 GTI/Jetta 1,6 GTI	09/84=>	550/820	<b>01.328</b>	191721335C-191721335M	0,315
Golf GTI/Jetta GLI	87=>89	550/820	<b>01.328</b>	191721335C-191721335M	0,315
Golf 1,3-1,5/Jetta 1,5	86=>	820/1115	<b>01.231</b>	191721335J-191721335R	0,290
Golf GTI-Jetta GLI (a/a)	86=>	550/805	<b>01.389</b>	191721335G-191721335Q	0,351
Golf GTI/Jetta GLI (manual adjust)	86=>	550/830	<b>01.0368</b>	191721335G-191721335Q	0,270
Golf GTI/Jetta GLI (a/a)	90=>	530/800	<b>01.382</b>	191721335AB	0,425
Golf GTI/Jetta GLI (manual adjust)	90=>	520/830	<b>01.0307</b>	191721335AB	0,324
Golf D/Jetta D	09/84=>	575/850	<b>01.240</b>	191721335D	0,226
Golf D/Jetta D	86=>	575/860	<b>01.237</b>	191721335N	0,225
Golf D-GTD/Jetta D (a/a)	90=>	820/1080	<b>01.391</b>	191721335F	0,492
Golf D/Jetta D (manual adjust)	90=>91	810/1115	<b>01.0309</b>	191721335F	0,453
Golf/Vento BZ-D (a/a)	90=>	530/820	<b>01.386</b>	1H1721335A-1H1721335B	0,410
Golf/Vento BZ (manual adjust)	09/91=>09/92	510/855	<b>01.0308</b>	1H1721335A-1H1721335B	0,331
Golf/Vento BZ (a/a)	09/96=>	700/1050	<b>01.0232</b>	1H1721335M-1H1721335H 1H1721335K-1H1721335C	0,764
Golf/Vento BZ (manual adjust)	09/96=>	710/1055	<b>01.0306</b>	1H1721335M-1H1721335H	0,577
Golf/Vento BZ (manual adjust)	09/92=>	580/910	<b>01.0370</b>	1H1721335K-1H1721335C	0,523
Scirocco all	=>75	675/915	<b>01.293</b>	531721335A	0,267
Scirocco all	76=>	680/885	<b>01.294</b>	531721335C	0,251

Cavo Frizione Autoregistrante - Selfadjusting Clutch Cables - à rattrapage Automatique - Samostavitelná spojková lanka - Саморегулируемые тросы сцепления  
Cavo Frizione Registrazione Manuale - Manual Adjusting Clutch Cable - à réglage manuel - Spojkové lanko staviteľné ručně - Тросы сцепления ручного регулирования

**CAVI FRIZIONE - CLUTCH CABLES - CABLES DE DEBRAYAGE  
KUPPLUNGSSEILE - CABLES EMBRAGUE - CABOS DE EMBRAIAGEM  
LINKI SPRZĘGŁA - SPOJKOVÁ LANKA - ТРОСЫ СЦЕПЛЕНИЯ**

				<b>OEM REF.</b>	
---	---	---	--	-----------------	---

**VOLKSWAGEN**

Scirocco all (a/a)	86=>	810/1030	<b>01.394</b>	533721335C	0,457
Scirocco all (manual adjust)	86=>	800/1065	<b>01.0310</b>	533721335C	0,365
Passat/Dasher	75=>	655/950	<b>01.567</b>	843721335	0,328
Passat/Dasher	01/78=>10/78	805/1100	<b>01.429</b>	321721335B	0,397
Passat/Dasher	11/78=>	805/1115	<b>01.671</b>	321721335C	0,414
Passat/Santana (4 cyl.)	79=>83	640/940	<b>01.249</b>	811721335F	0,323
Passat/Santana (4 cyl.)	84=>	680/960	<b>01.247</b>	321721335H	0,310
Passat/Santana (5 cyl.)	84=>	685/970	<b>01.248</b>	321721335G	0,372
Passat/Santana all (exc.D) (a/a)	89=>	960/1295	<b>01.395</b>	357721335E	0,524
Passat/Santana all (manual adjust)	89=>	950/1335	<b>01.0311</b>	357721335E	0,425
Passat/Santana D	79=>83	650/940	<b>01.603</b>	811721335H	0,390
Passat/Dasher D-TD/Santana	83=>89	670/970	<b>01.602</b>	321721335E-321721335D	0,413



**VOLKSWAGEN - Commercial Vehicle**

Caddy all	76=>	580/810	<b>01.297</b>	171721335E	0,227
Caddy all	09/83=>	545/810	<b>01.528</b>	191721335A	0,214
Caddy all BZ-Petrol-Gasol	95=>	804/1065	<b>01.0222</b>	6K1721335G-6K1721335H	0,338
Caddy all D (a/a)	95=>	640/860	<b>01.0225</b>	6K1721335B-6K1721335C	0,390
Caddy all (manual adjust)	95=>	598/865	<b>01.0313</b>	6K1721335B-6K1721335C	0,294
Transporter 1,6	71=>	3200	<b>01.302</b>	211721335G	0,192
Transporter 1,7-1,8	72=>75	3220	<b>01.233</b>	211721335J	0,186
Transporter 2,0	76=>	3215	<b>01.303</b>	211721335H	0,173
Transporter 1,6-2,0	80=>	360/3800	<b>01.484</b>	251721335	0,414
Transporter T4 all (a/a)	09/90=>	960/1250	<b>01.403</b>	701721335-701721335B	0,557
Transporter T4 all (manual adjust)	09/90=>	920/1290	<b>01.0312</b>	701721335-701721335B 7D1721335	0,400
LT (Perkins mot. 4 cyl.)	=>75	1580/1725	<b>01.574</b>	281721335	0,471
LT	75=>	1545/1705	<b>01.431</b>	281721335A	0,617
LT	83=>	1670/1830	<b>01.618</b>	281721335B	0,697
LT	89=>	1600/1820	<b>01.0233</b>	281721335E	0,718

**VOLKSWAGEN**

**GUAINE PROTEZIONE CAVI FRIZIONE/SLEEVE CABLES**

1500/1600 (type 3)		305	<b>01.057</b>	311721361	0,155
Transporter	74=>	330	<b>01.059</b>	211721361C-211721361D	0,155
Transporter 2,0	79=>	295	<b>01.061</b>	251721361B	0,191

**VOLVO**

142/144/145 all	69=>	1030/1170	<b>01.222</b>	12062055	0,501
343/345 B14 (-ch. 609999)	=>80	852/1112	<b>01.568</b>	32947541-32032948	0,341

Cavo Frizione Autoregistrante - Selfadjusting Clutch Cables - à rattrapage Automatique - Samostavitelná spojková lanka - Саморегулируемые тросы сцепления  
Cavo Frizione Registrazione Manuale - Manual Adjusting Clutch Cable - à réglage manuel - Spojkové lanko staviteľné ručně - Тросы сцепления ручного регулирования

**CAVI FRIZIONE - CLUTCH CABLES - CABLES DE DEBRAYAGE  
KUPPLUNGSSEILE - CABLES EMBRAGUE - CABOS DE EMBRAIAGEM  
LINKI SPRZĘGŁA - SPOJKOVÁ LANKA - ТРОСЫ СЦЕПЛЕНИЯ**

				<b>OEM REF.</b>	
---	---	---	--	-----------------	---

**VOLVO**

343/345 B14 (ch. 610000-)-B19	80=>	800/1050	<b>01.569</b>	32947046-32831067	0,302
340 B14 (ch. 796163-120999)	=>85	852/1112	<b>01.568</b>	32032948	0,341
340 B14 (ch. 121000-)	86=>90	870/1155	<b>01.068</b>	32092538	0,339
240/260/740 all BZ	74=>	920/1080	<b>01.287</b>	1228633-12289120-13776695	0,484
240/260/760 GLE-D	79=>	970/1120	<b>01.496</b>	12722294	0,550
440 GL-GLT-T	88=>	790/1030	<b>01.069</b>	3450294-34509158-3450915	0,288
440/460 all (ch. 12314-185080)	89=>91	750/1010	<b>01.0317</b>	33441767-33446600	0,310
440/460 T	91=>	775/1030	<b>01.0263</b>	3460763-3470372-34598680	0,307
460 TD	93=>	1350/1575	<b>01.0319</b>	3475466	0,495
480 ES (ch. 521203)	88=>	710/1025	<b>01.070</b>	33441726-3344858-3344661	0,274
480 T (ch. 523614-565116)	88=>91	750/1010	<b>01.0317</b>	3344176-3344856	0,310
480 T	91=>	775/1030	<b>01.0263</b>	3460763-3470372-34598680	0,307

**ZASTAVA**

Yugo 45	=>86	355/505	<b>01.467</b>	4402475	0,129
Yugo 45	87=>	360/530	<b>01.075</b>	46625514-46623277	0,159
Yugo Florida-Miami	89=>	360/610	<b>01.071</b>	46618456	0,179
101	83=>		<b>01.1246</b>		•













**automotive products**



**COMANDI ARIA CARBURATORE  
CHOKE CABLES  
TIRETTES DE STARTER  
STARTERZUGE  
CABLES DE CHOQUE  
CABOS DE CHOKE  
LINKI SSANIA  
LANKA SYTIČE  
ТРОСЫ УПРАВЛЕНИЯ  
ДРОССЕЛЬНОЙ ЗАСЛОНКОЙ  
КАРБЮРАТОРА**

ALFA ROMEO .....	pag. 31
CITROEN .....	pag. 31
FIAT .....	pag. 31-32
LADA VAZ .....	pag. 32
LANCIA .....	pag. 32
PEUGEOT.....	pag. 32-33
POLSKI.....	pag. 33
RENAULT.....	pag. 33
SEAT .....	pag. 33
TALBOT.....	pag. 33-34
ZASTAVA .....	pag. 34

**COMANDI ARIA CARBURATORE - CHOKE CABLES - TIRETTES DE STARTER  
STARTERZUGE - CABLES DE CHOQUE - CABOS DE CHOKE  
LINKI SSANIA - LANKA SYTIČE - ТРОСЫ УПРАВЛЕНИЯ ДРОСсельНОЙ ЗАСЛОНКОЙ КАРБЮРАТОРА**

				OEM REF.	
<b>ALFA ROMEO</b>					
Alfasud all 		1200/1620	<b>02.135</b>	531733-531730-542774	•
33 all 		1200/1620	<b>02.135</b>	531733-531730-542774	•
Alfetta/2000			<b>02.236</b>	105124203700-105124203703	•

<b>CITROEN</b>					
2 CV/Dyane/Mehari/Ami 6-8	76=>	1270/1620	<b>02.210</b>	5470139-5470931-5459284	•
LN		1090/1200	<b>02.211</b>	5490886	•
AX (-ch.3856) 	86=>	1500/1570	<b>02.112</b>	95613456	0,175
Axel 	85=>	1400/1530	<b>02.114</b>	95493245	0,162
GS	=>73	1170/1255	<b>02.212</b>	GX54119601A	0,134
BX 14 	83=>	1620/1770	<b>02.264</b>	95495357	0,173
BX 16 	83=>	1050/1190	<b>02.265</b>	95597849	•

<b>FIAT</b>					
500 D-F-L		1460/2000	<b>02.101</b>	4017952-4017953	0,173
500 D-F-Giardiniera		1560/2000	<b>02.102</b>	4050429-875675	0,162
500/600/850 (unif. inner cable)		3700	<b>02.103</b>	4017953-875675	0,037
500 R		1460/1835	<b>02.100</b>	4230244-4230245	0,149
126		1460/1835	<b>02.100</b>	4230244-4230245	0,149
126 (inner cable only)		1600	<b>02.105</b>	4230245	0,023
126 Bis	87=>	1790/1930	<b>02.180</b>	7558587-7558588	0,184
Cinquecento 700cc (Cat.)	93=>	1510	<b>02.093</b>	1824752780	0,101
600 D-E		1730/2350	<b>02.104</b>	4006240-4007356	0,179
850 all		1570/1960	<b>02.107</b>	4103231-4103232	0,178
Panda all	80=>	1150/1380	<b>02.176</b>	4406531-4467961-7609324	0,112
Panda all	92=>	1026/1105	<b>02.252</b>	7699920	•
127 CL-Sport	06/77=>	945/1010	<b>02.154</b>	4380848-4418455	0,104
127 all	=>05/77	1150/1380	<b>02.176</b>	4254544-4275259	0,112
127 all/Fura	82=>	940/1030	<b>02.214</b>	5954768-5936040	0,088
127/147 (Brazil)	82=>	1150/1380	<b>02.176</b>	4349177-4376917-4377951	0,112
Uno 45	83=>	1170/1270	<b>02.195</b>	5954247	0,050
Uno all 	83=>	1170/1280	<b>02.196</b>	5954276	0,119
Uno	89=>	1042/1149	<b>02.400</b>	182179480	0,167
Uno 	89=>	976/1108	<b>02.401</b>	182179580	0,150
Uno CS 	87=>	1170/1290	<b>02.115</b>	181036570-181036580	0,128

**COMANDI ARIA CARBURATORE - CHOKE CABLES - TIRETTES DE STARTER  
STARTERZUGE - CABLES DE CHOQUE - CABOS DE CHOKE  
LINKI SSANIA - LANKA SYTIČE - ТРОСЫ УПРАВЛЕНИЯ ДРОССЕЛЬНОЙ ЗАСЛОНКОЙ КАРБЮРАТОРА**

				<b>OEM REF.</b>	
---	---	---	--	-----------------	---

<b>FIAT</b>					
128 all		1150/1380	<b>02.176</b>	4218530-4273441-4275280 4275286-4376917-4377951	0,112
128 all-128 Sport	82=>	1150/1380	<b>02.176</b>	4218530-4273441-4275286	0,112
Duna ⚡	87=>	1170/1290	<b>02.115</b>	181036570-181036580	0,128
Ritmo all	=>09/82	1700/1330	<b>02.157</b>	4406453-4436802-4449977	0,049
Ritmo ⚡	10/82=>	1335/1410	<b>02.197</b>	5963586	0,211
Tipo 1,1 ⚡	88=>	900/1200	<b>02.181</b>	181211280	0,144
Tipo 1,4-1,6 ⚡	88=>	1050/1190	<b>02.182</b>	181304280	0,120
Regata all ⚡	10/82=>	1335/1410	<b>02.197</b>	5963586	0,211
Tempra 1,4-1,6	90=>	970/1170	<b>02.001</b>	181721280-182333580	0,162
132 1,6-1,8 ⚡		765/880	<b>02.122</b>	4284483	0,095







<b>FIAT - Commercial Vehicle</b>					
600 T/850 T	=>73	2670/3700	<b>02.106</b>	4059160-4059161	0,274
850 T/900 T	73=>	2600/4100	<b>02.175</b>	4230310	•
850 T/900 T (inner cable only)	73=>	4100	<b>02.108</b>	4230310	0,042
Fiorino (900cc)	82=>	940/1030	<b>02.214</b>	5954768-5936040	0,088
Fiorino BZ (Brazil)		1150/1380	<b>02.176</b>	4349177	0,112
Fiorino BZ	88=>	1360/1450	<b>02.253</b>	7542825	0,125



<b>LADA VAZ</b>					
1200		720/900	<b>02.171</b>	21011108100	•
1300/1500/1600/Niva		1100/1220	<b>02.224</b>	21031108100-21051108100	0,139
Samara		1100/1290	<b>02.002</b>	21081108100	0,185

<b>LANCIA</b>					
A112 all		1150/1380	<b>02.176</b>	4206761-4288608	0,112
A112 LX ⚡		845/930	<b>02.200</b>	82393671	0,127
Y10 Fire-Touring-Turbo ⚡	85=>	1000/1120	<b>02.183</b>	7535578-7573808-7584703 5994618-7533799	0,119
Y10 all	92=>	1120	<b>02.168</b>	7702943	•

<b>PEUGEOT</b>					
104/204/304/404/504		1220/1325	<b>02.226</b>	166165-166171	0,192
104		1170/1295	<b>02.227</b>	166186	0,060
205	83=>	850/930	<b>02.117</b>	166011-166013	0,159

COMANDI ARIA CARBURATORE - CHOKE CABLES - TIRETTES DE STARTER STARTERZUGE - CABLES DE CHOQUE - CABOS DE CHOKE LINKI SSANIA - LANKA SYTIČE - ТРОСЫ УПРАВЛЕНИЯ ДРОССЕЛЬНОЙ ЗАСЛОНКОЙ КАРБЮРАТОРА					
				OEM REF.	
<b>PEUGEOT</b>					
305	=>83	1270/1370	<b>02.228</b>	166184	•
305	83=>	1560	<b>02.119</b>	166035	•
309 1,1-1,3 (mot. E1A)	85=>	1060/1170	<b>02.300</b>	166026	0,200
309 1,6 (XU51C)	85=>	920/1010	<b>02.301</b>	166025	0,187

<b>POLSKI</b>					
125 P		600/960	<b>02.120</b>	4070428	0,224
126 Bis	87=>	1790/1930	<b>02.180</b>	7558587-7558588	0,184
Polonez 1,3-1,5		1150/1380	<b>02.176</b>	4384840	0,112







<b>RENAULT</b>					
R4/R6	=>79	730/845	<b>02.205</b>	7700500708-7701346519 7700526998	0,089
R5	=>79	1420	<b>02.206</b>	7700548173	•
R5/R9/R11/R14/R18 	79=>	1660	<b>02.269</b>	7704000093-7701365520 7704348431	0,196
Supercinque 	84=>	1795	<b>02.270</b>	7700766035	0,187
Clio	90=>	1700	<b>02.290</b>	7700803223	0,200
R19 TS-GTS-TSE 		1900	<b>02.283</b>	7700793639	•

 					
<b>RENAULT - Commercial Vehicle</b>					
Express 	84=>	1795	<b>02.270</b>	7700766035	0,187

<b>SEAT</b>					
Marbella		1150/1380	<b>02.176</b>	HB11010202	0,112
Panda		1150/1380	<b>02.176</b>	HB11010202	0,112
133		1570/1960	<b>02.107</b>	EA11011000	0,178
127		1150/1380	<b>02.176</b>	HB11010202	0,112
127 C-CL		945/1010	<b>02.154</b>	HH11010202	0,104
Ibiza		1395	<b>02.003</b>	X039519800	0,151
124		1150/1380	<b>02.176</b>	HB11010202	0,112

<b>TALBOT</b>					
1100	76=>	1100/1180	<b>02.230</b>	47150B-16723900	0,185

**COMANDI ARIA CARBURATORE - CHOKE CABLES - TIRETTES DE STARTER  
 STARTERZUGE - CABLES DE CHOQUE - CABOS DE CHOKE  
 LINKI SSANIA - LANKA SYTIČE - ТРОСЫ УПРАВЛЕНИЯ ДРОСсельной ЗАСЛОНКОЙ КАРБЮРАТОРА**

				<b>OEM REF.</b>	
<b>TALBOT</b>					
Horizon 		1590/1700	<b>02.233</b>	521580200	0,173
1307/1308	=>77	1760	<b>02.231</b>	47077A-48071C	0,250
1307/1308/1510/Solara	77=>	1610/1710	<b>02.232</b>	16743400	0,186

<b>ZASTAVA</b>					
Jugo 45		1150/1380	<b>02.176</b>	4436682	0,112
Jugo/Florida/Miami	89=>	1460	<b>02.005</b>	46618640	0,264







**automotive products**

**COMANDI APERTURA COFANO**  
**BONNET CABLES**  
**CABLES CAPOT**  
**HAUBENZUGE**  
**CABLES DE CAPOTA**  
**CABOS DO CAPOT**  
**LINKI MECHANIZMU PODNOSZENIA**  
**MASKI**  
**ЛАНКА КАРОТУ**  
**ТРОСЫ КАПОТА**

ALFA ROMEO.....	pag. 35
AUDI .....	pag. 35
BMW .....	pag. 35
CITROEN .....	pag. 35
FIAT .....	pag. 35-37
INNOCENTI (BRITISH LEYLAND) .....	pag. 37
LADA VAZ .....	pag. 37
LANCIA .....	pag. 37
MERCEDES .....	pag. 37
OPEL .....	pag. 37
PEUGEOT.....	pag. 37
POLSKI.....	pag. 38
RENAULT.....	pag. 38
SEAT.....	pag. 38
SUZUKI.....	pag. 38
TALBOT.....	pag. 38
VOLKSWAGEN.....	pag. 38
ZASTAVA.....	pag. 38

**COMANDI APERTURA COFANO - CABLES CAPOT - BONNET CABLES  
HAUBENZUGE - CABLES DE CAPOTA - CABOS DO CAPOT  
LINKI MECHANIZMU PODNOSZENIA MASKI - LANKA KAPOTY - ТРОСЫ КАПОТА**

				OEM REF.	
<b>ALFA ROMEO</b>					
Alfasud (rear boot)		2400/2850	<b>03.125</b>	510105	0,240
Alfasud (inner)		1250	<b>03.419</b>	518086	•
33 all		1125	<b>03.122</b>	60504313	0,130
Giulia all		1310/1560	<b>03.124</b>	105485602001	0,040
1750/2000		1250/1550	<b>03.123</b>	105485602006	0,160
1750/2000		680/840	<b>03.216</b>	105485602000-105485602003	•
2.0 Spyder (sport. BZ)		1680/1860	<b>03.204</b>	60520126	0,200
2.0 Spyder (rear boot)		2900/3100	<b>03.206</b>	105955603501	0,310
2.0 Spyder (rear boot)	71=>	2048/2248	<b>03.401</b>	105955603500	0,230





<b>AUDI</b>					
80		1460/2270	<b>03.108</b>	811823531	0,050

<b>BMW</b>					
Serie 3-5 all (inner only)		1490	<b>03.307</b>	51231817624-51231827318	0,020
Serie 3-5 all			<b>03.308</b>	51231960853	0,080

<b>CITROEN</b>					
AX		1310/1480	<b>03.132</b>	95631877	•
Visa		1600	<b>03.133</b>	95611132	•
BX		1425/1845	<b>03.134</b>	95568309-95496410	0,070

<b>FIAT</b>					
500 D-Giardiniera		950/1370	<b>03.101</b>	970131-985992	0,110
500 F-L-R		950/1560	<b>03.102</b>	4109112-4170429	0,100
126 all		615/1210	<b>03.100</b>	4313078-4313079	0,070
126 Bis	87=>	220/340	<b>03.135</b>	7543700-7543701	•
Cinquecento (rear boot)	92=>	2130/2290	<b>03.350</b>	7692023	0,320
600 D		940/1250	<b>03.106</b>	4108491-4108492	•
850 all		580/1490	<b>03.107</b>	4106392	•
Panda	=>81	1430/1550	<b>03.161</b>	4404120-4204121	0,040
Panda	81=>	1370/1550	<b>03.219</b>	4484785	0,050
Panda 750/1000	=>89	1385/1600	<b>03.208</b>	5967166-7602810-7962685	0,050
127 all		740/1250	<b>03.104</b>	4237699-4237700-4405267	0,080
127 Brasil/147		740/1250	<b>03.104</b>	4237699-4237700-4405267	0,080
Uno all	=>89	1385/1600	<b>03.208</b>	5967166-7602810-7962685	0,050
Uno all (rear boot)	=>89	2675/2785	<b>03.209</b>	5967167	0,260

**COMANDI APERTURA COFANO - CABLES CAPOT - BONNET CABLES  
HAUBENZUGE - CABLES DE CAPOTA - CABOS DO CAPOT  
LINKI MECHANIZMU PODNOSZENIA MASKI - LANKA KAPOTY - ТРОСЫ КАПОТА**

				OEM REF.	
<b>FIAT</b>					
Uno R89 (rear boot)	89=>	2250/2425	<b>03.120</b>	7637710-7710408	0,210
Uno CS	87=>	1370/1600	<b>03.139</b>	5973151	0,040
Duna	87=>	1370/1600	<b>03.139</b>	5973151	0,040
Duna Weekend (rear boot)	87=>	2680/2760	<b>03.137</b>	7544076	•
128 all		755/1500	<b>03.112</b>	4193933-4265207	•
Palio 1,3-1,6	97=>	1380/1575	<b>03.362</b>	46455996	0,150
Palio all (rear boot)	97=>	2662/2761	<b>03.363</b>	46432588	0,240
Punto all	11/93=>	1500	<b>03.000</b>	7736069	0,140
Punto all (rear boot)	11/93=>	2580	<b>03.001</b>	7734573	0,240
Idea	03=>		<b>03.118</b>	46844599	0,060
X 1/9		450/540	<b>03.200</b>	4245888-4245868	•
X 1/9 (cofano mot.) (front-avt)		1180/1430	<b>03.215</b>	4246012	0,170
X 1/9 (5 speed-marce) (rear)		1700/1820	<b>03.159</b>	4246009-4246020	0,050
X 1/9 5 speed (front-avt)		725/910	<b>03.198</b>	4403334	0,110
Ritmo/Regata		1685/1850	<b>03.147</b>	4380817-4380818	0,120
Tipo/Tempra	88=>	1360/1495	<b>03.136</b>	7602979-7663094	0,040
124 all		780/1150	<b>03.109</b>	4135975-4163409-4274553 4274554	0,040
131 all		830/1810	<b>03.115</b>	4340126-4340128-4352898	0,090
1300/1500		1810/2270	<b>03.114</b>	4061949	•
125 all		810/950	<b>03.111</b>	4157458	•
132 all		780/1150	<b>03.109</b>	4135975-4163409-4274553 4274554	0,040
Croma all	86=>	1550/2360	<b>03.138</b>	82415297	0,210
<b>FIAT - KIT COMPLETO STANDARD</b>					
500/126/600 D/850/127/Panda/128/Ritmo/Regata 124/131/132/Ducato			<b>03.207</b>		0,050
<b>FIAT - INNER CABLES</b>					
Panda (inner only)	=>81		<b>03.420</b>	4380818-4404121	•
Panda (inner only)	82=>	1500	<b>03.220</b>	4484785	0,040
124/126/127/128/131/132/500/850/Panda/Ritmo (inner only)			<b>03.146</b>		0,020
Ritmo/Regata/Ducato/Daily (inner only)			<b>03.420</b>	4380818-4404121	•

**COMANDI APERTURA COFANO - CABLES CAPOT - BONNET CABLES  
HAUBENZUGE - CABLES DE CAPOTA - CABOS DO CAPOT  
LINKI MECHANIZMU PODNOSZENIA MASKI - LANKA KAPOTY - ТРОСЫ КАПОТА**



OEM REF.



**FIAT - Commercial Vehicle**

Fiorino		1370/1600	<b>03.139</b>	5973151	0,040
Fiorino (porta post.)			<b>03.352</b>	7519178	•
Ducato		1380/1890	<b>03.197</b>	4401246-4401247	0,050

**INNOCENTI (BRITISH LEYLAND)**

Mini 90/120 (porta post.)		2345/2505	<b>03.406</b>	53471006	•
---------------------------	--	-----------	---------------	----------	---

**LADA VAZ**

1200/1300/1500		780/1140	<b>03.109</b>	21018406142	0,040
----------------	--	----------	---------------	-------------	-------

**LANCIA**

A 112	=>77	715/1520	<b>03.121</b>	4204667-4204668	•
A 112	78=>	530/780	<b>03.221</b>	4482419-4482342	0,040
Y10	85=>	1395/1570	<b>03.241</b>	5979003-5979004	0,050
Y all	96=>	1330/1490	<b>03.364</b>	46417288	0,160
Prisma		400/550	<b>03.246</b>	82393341	•
Dedra	90=>		<b>03.407</b>	82483355	•
Thema	86=>	1575/2415	<b>03.140</b>	82415203-82450563	0,210
Kappa	90=>		<b>03.407</b>	82483355	•

**MERCEDES**

200	70=>	1770/1850	<b>03.182</b>	1158800159-1158800059	0,270
200/280		1870/1950	<b>03.183</b>	1238800158-1238800159	0,080

**OPEL**

Corsa A	=>92		<b>03.371</b>	1178447-90119337	0,080
Corsa B	93=>		<b>03.372</b>	1178462-90482081	0,240
Astra/Vestra/Ascona/Kadett		1577/1653	<b>03.373</b>	1178451-90159584	0,090

**PEUGEOT**

104/204/304/404/504/604		1410/1660	<b>03.211</b>	793716	•
205		1570/1720	<b>03.141</b>	793765	•
309		1500/1675	<b>03.142</b>	793775	0,190
405	=>93	380/460	<b>03.148</b>	793780	0,040
405	93=>	1350	<b>03.128</b>	793793-793797	0,150

**COMANDI APERTURA COFANO - CABLES CAPOT - BONNET CABLES  
HAUBENZUGE - CABLES DE CAPOTA - CABOS DO CAPOT  
LINKI MECHANIZMU PODNOSZENIA MASKI - LANKA KAPOTY - ТРОСЫ КАПОТА**



OEM REF.



**POLSKI**

126		600/1250	<b>03.100</b>	4313078-4313079	0,070
126 Bis		220/340	<b>03.135</b>	7543700-7543701	•
125 P		1810/2270	<b>03.114</b>	4061649	•

**RENAULT**

R5 all		805/870	<b>03.149</b>	7701348950	0,130
R18 all/Fuego		1780	<b>03.127</b>	7701348670	•

**SEAT**

Panda		1370/1430	<b>03.219</b>	X04404120	0,050
Marbella		1670/1930	<b>03.162</b>	SE141559630A-SE141559640A	•
127		740/1150	<b>03.104</b>	HB55964000	0,080
Ritmo/Ronda/Malaga		1685/1850	<b>03.147</b>	RF13032702	0,120
Ibiza		1150/1440	<b>03.151</b>	SR138559630A	0,160
124		780/1140	<b>03.109</b>	FA55922800	0,040

**SUZUKI**

SJ 410/413	87=>		<b>03.416</b>	8216080010	•
------------	------	--	---------------	------------	---

**TALBOT**

Samba		1410/1660	<b>03.211</b>	793716	•
-------	--	-----------	---------------	--------	---

**VOLKSWAGEN**

Polo/Derby		1580/1650	<b>03.126</b>	867823531	0,080
Polo/Derby			<b>03.374</b>	867823531B	0,050
Polo Classic/Polo SW	96=>	1600/1635	<b>03.375</b>	6N1823531	0,040
Golf	=>08/83	1625/1715	<b>03.145</b>	171823531	0,080
Golf	09/83=>	1690/1750	<b>03.144</b>	191823531-192823531	0,060
Golf	10/91=>		<b>03.417</b>	1H1823531	0,050
Scirocco		1650/1770	<b>03.192</b>	531823531	•
Passat	=>77	1800/1950	<b>03.248</b>	321823531A	0,080
Passat	78=>	1970/2020	<b>03.250</b>	321823531C-321823531D	0,080
Transporter T	91=>	1614/1667	<b>03.376</b>	701823531B	0,050

**ZASTAVA**

Florida/Miami		1690	<b>03.210</b>	46616224	•
---------------	--	------	---------------	----------	---







**automotive products**

**COMANDI AVVIAMENTO MOTORINO  
COMPLETE STARTER CABLES  
CABLES COMPLETS DEMARREUR  
ANLASSERLEITUNGEN  
CABLES DE MOTORILLO  
CABOS DE M/ARRANQUE  
CIEGNA ROZRUSZNIKA  
LANKA STARTÉRU  
ПРОВОДА СТАРТЕРА**

FIAT..... pag. 39

**COMANDI AVVIAMENTO MOTORINO - COMPLETE STARTER CABLES  
 CABLES COMPLETS DEMARREUR - ANLASSERLEITUNGEN - CABLES DE MOTORILLO  
 CABOS DE M/ARRANQUE - CIEGNA ROZRUSZNIKA - LANKA STARTÉRU - ПРОВОДА СТАРТЕРА**

				OEM REF.	
<b>FIAT</b>					
126	73=>	1230	<b>04.100</b>	4297135	0,078
500 D		1160	<b>04.102</b>	4082456-4102883	0,094
500 F-L	=>72	1150	<b>04.103</b>	4111483-4117460	0,094
500 L	72=>	1150	<b>04.104</b>	4112474-4212571	0,093
500 R	73=>	1230	<b>04.100</b>	4297135	0,078
500 D Giardiniera		1310	<b>04.105</b>	4065010-4102884	0,098
500 F Giardiniera	=>72	1320	<b>04.106</b>	4124929	0,099
500 F-L Giardiniera	73=>	1310	<b>04.107</b>	4231737	0,094







**automotive products**





**COMANDI ACCELERATORE A  
PEDALE  
ACCELERATOR CABLES  
(THROTTLE)  
CABLES D' ACCELERATEUR  
VERGASERZUGE  
CABLES DE ACELERADOR  
CABOS DE ACELERADOR  
LINKI GAZU  
LANKA PEDÁLU PLYNU  
ТРОСЫ ГАЗА**

ALFA ROMEO .....	pag. 40
AUDI .....	pag. 41
BMW .....	pag. 41-42
CITROEN .....	pag. 42-44
FERRARI .....	pag. 44-45
FIAT .....	pag. 45-51
FORD .....	pag. 51-52
HONDA .....	pag. 52
INNOCENTI .....	pag. 52
LADA VAZ .....	pag. 52
LANCIA .....	pag. 52-54
MERCEDES .....	pag. 54
NISSAN .....	pag. 54-55
OPEL .....	pag. 55-56
PEUGEOT .....	pag. 56-59
POLSKI .....	pag. 59
RENAULT .....	pag. 60-63
ROVER .....	pag. 63-64
SAAB .....	pag. 64
SEAT .....	pag. 64-65
SKODA .....	pag. 65
SUBARU .....	pag. 66
SUZUKI .....	pag. 66
TALBOT .....	pag. 66
TOYOTA .....	pag. 66-67
VOLKSWAGEN .....	pag. 67-69
VOLVO .....	pag. 69
ZASTAVA .....	pag. 69

**COMANDI ACCELERATORE A PEDALE - ACCELERATOR CABLES (THROTTLE) - CABLES D'ACCELERATEUR  
VERGASERZUGE - CABLES DE ACELERADOR - CABOS DE ACELERADOR  
LINKI GAZU - LANKA PEDÁLU PLYNU - ТРОСЫ ГАЗА**





				OEM REF.	
<b>ALFA ROMEO</b>					
Alfasud N (5 speed)	70=>	715/815	<b>05.148</b>	530751	0,085
Alfasud TI-Sprint	72=>	890/1000	<b>05.298</b>	530631	0,139
Alfasud Super 1,2-1,3-1,5	76=>	720/810	<b>05.578</b>	533299	0,108
Alfasud TI-Sprint	76=>	890/990	<b>05.581</b>	533354	0,129
Alfasud TI-Sprint	81=>	600/720	<b>05.579</b>	536577-60506803	0,095
Arna 1,2	83=>	550/650	<b>05.723</b>	542545	0,058
Arna TI	83=>	485/580	<b>05.724</b>	542659	0,056
Alfa 33 all (single carb.)	83=>	785/890	<b>05.725</b>	542776-60504315	0,119
Alfa 33 all (twin carb.)	83=>	600/720	<b>05.579</b>	536577-60506803	0,095
Alfa 33 1,7	86=>	565/715	<b>05.910</b>	549491-60537915	0,101
Alfa 33 1,8 TD	86=>	750/925	<b>05.000</b>	60537910	0,081
Alfa 33 1,7ie	88=>	1005/1155	<b>05.913</b>	60537971	0,141
Giulietta 1,6-1,8-2,0	83=>	620/780	<b>05.730</b>	117014405102-60523120	0,084
Giulietta 2,4 TD	83=>	615/745	<b>05.441</b>	117023905100-60734859	0,108
Alfa 75 1,6-1,8-2,0	83=>	620/780	<b>05.730</b>	117014405102-60523120	0,084
Alfa 75 TD	85=>	595/735	<b>05.553</b>	161043105401-60528459	•
Alfa 75 Twin Spark	87=>	755/895	<b>05.558</b>	60534138-162243105401	0,156
Alfa 75 2,5-3,0	87=>	665/810	<b>05.559</b>	60533984-162183105400	0,074
Alfa 75 T Evoluzione	87=>	470/610	<b>05.262</b>	60518349	0,069
Alfa 90 1,8-2,0	83=>	620/780	<b>05.730</b>	117014405102-60523120	0,084
Alfa 90 TD	=>84	615/750	<b>05.447</b>	162060405600-60742180	0,090
Alfa 90 2,0ie	85=>	1055/1200	<b>05.728</b>	117134405102-60703269	0,175
Alfa 90 TD	85=>	595/735	<b>05.553</b>	161043105401-60528459	•
Alfa 90 TD	85=>	615/745	<b>05.441</b>	117023905100-60734859	0,108
155 all	92=>	760/940	<b>05.263</b>	60557449	0,164
156 1,6 TS	98=>	519/659	<b>05.0501</b>	60653544	0,114
156 1,8-2,0 TS	98=>	720/907	<b>05.0502</b>	60622696	0,160
Alfetta 2,0ie	83=>	1055/1200	<b>05.728</b>	117134405102-60703269	0,175
Alfetta	83=>	615/790	<b>05.727</b>	117014405101	0,100
Alfetta 2,4 TD	83=>	615/745	<b>05.441</b>	117023905100-60734859	0,108
Alfetta	83=>	620/780	<b>05.730</b>	117014405102-60523120	0,084
Alfetta/GTV/Spyder 2,0 (USA mod.)	72=>84	205/410	<b>05.577</b>	105504405101-60715011	0,050
Alfetta GTV 6	84=>	320/455	<b>05.676</b>	60701677	0,058
Spyder	89=>	840/990	<b>05.272</b>	60562135	0,161
164 Twin Spark	88=>	455/630	<b>05.003</b>	60511688-60561731	0,080
164 T 2,0	88=>	545/695	<b>05.004</b>	60511545	0,146
164 3,0 V6 (ch. 06212021-)	90=>	390/650	<b>05.270</b>	60563884	0,123
164 TD	88=>	1070/1280	<b>05.006</b>	60510138-60542561	0,230
166 2,0 TS	99=>	721/937	<b>05.0503</b>	60651739	0,126

**COMANDI ACCELERATORE A PEDALE - ACCELERATOR CABLES (THROTTLE) - CABLES D'ACCELERATEUR  
VERGASERZUGE - CABLES DE ACELERADOR - CABOS DE ACELERADOR  
LINKI GAZU - LANKA PEDÁLU PLYNU - ТРОСЫ ГАЗА**

				OEM REF.	
<b>AUDI</b>					
50	75=>	300/485	<b>05.210</b>	861721555A	•
50	75=>79	300/490	<b>05.383</b>	861721555	0,072
50	79=>	350/550	<b>05.718</b>	861721555F	0,083
A3 1,8 T	96=>	1035/1280	<b>05.0250</b>	1J0721555D-1J0721555T	0,241
A3 all 1,8 20v	=>97	1505/1710	<b>05.0210</b>	1J0721555J-1J0721555Q 1J1721555J	0,162
A3 1,8 20v	=>97	1505/1710	<b>05.0210</b>	1J0721555J-1J0721555Q 1J1721555J	0,162
A3 1,6	=>97	1505/1710	<b>05.0210</b>	1J0721555J-1J0721555Q 1J1721555J	0,162
A3 all (exc.1,8 T)	97=>	1505/1710	<b>05.0210</b>	1J0721555J-1J0721555Q 1J1721555J	0,162
A3 1,6		1505/1710	<b>05.0210</b>	1J0721555J-1J0721555Q 1J1721555J	0,162
80 GL-GLS 1,6	09/78=>79	580/810	<b>05.341</b>	811721555D	0,100
80 GL-GLS 1,6	09/79=>81	665/860	<b>05.342</b>	811721555C	0,128
80 GLS 1,6-1,9	08/81=>	805/1035	<b>05.339</b>	811721555AL-811721555AD	0,125
80 1,6	86=>	680/900	<b>05.344</b>	811721555AA	0,110
80 1,8-Quattro/90 Quattro	=>87	530/905	<b>05.008</b>	811721555AM	0,129
80 2,2	86=>	565/960	<b>05.401</b>	811721555AB	0,125
80 D-TD		515/740	<b>05.764</b>	321721555F-321721555R 811721555AE	0,087
100 1,6 (4 cyl)	76=>	870/1100	<b>05.277</b>	431721555K	0,147
100	78=>	755/1165	<b>05.343</b>	431721555C	0,108
100 1,9-2,2	08/80=>	1055/1300	<b>05.732</b>	431721555J	0,199
100 2,2 (5 cyl)	78=>83	780/1180	<b>05.770</b>	431721555L	•
100 2,2 (5 cyl) (autotrans)	78=>	405/690	<b>05.278</b>	431723555D	•
100 D (5 cyl)	77=>	465/660	<b>05.733</b>	431721555N	•
200 T	91=>	935/1270	<b>05.281</b>	447721555	0,149

<b>BMW</b>					
315		620/800	<b>05.779</b>	35411153166	•
316 (4 cyl)	=>80	455/650	<b>05.605</b>	35411116161	0,074
316 (4 cyl)	80=>	490/600	<b>05.606</b>	35411152684	0,081
316	=>09/83	420/570	<b>05.299</b>	35411154282	0,086
316	10/83=>87	420/600	<b>05.304</b>	35411154823	0,081
316i	10/87=>	525/760	<b>05.305</b>	35411154625	0,106
316	88=>	560/800	<b>05.0504</b>	35411160526	0,109
316 (autotrans)	90=>	566/795	<b>05.0505</b>	35411160938	0,101
318 (4 cyl)	=>80	455/650	<b>05.605</b>	35411116161	0,074
318i (4 cyl)	80=>	490/600	<b>05.606</b>	35411152684	0,081
318i	88=>	560/800	<b>05.0504</b>	35411160526	0,109
318i (autotrans)	90=>	566/795	<b>05.0505</b>	35411160938	0,101
320 (4 cyl)	=>80	455/650	<b>05.605</b>	35411116161	0,074
320i (4 cyl)	82=>	490/640	<b>05.780</b>	35411116187	0,083
320 M60 (6 cyl)	=>82	670/800	<b>05.607</b>	35411120357	0,096

**COMANDI ACCELERATORE A PEDALE - ACCELERATOR CABLES (THROTTLE) - CABLES D'ACCELERATEUR  
VERGASERZUGE - CABLES DE ACELERADOR - CABOS DE ACELERADOR  
LINKI GAZU - LANKA PEDÁLU PLYNU - ТРОСЫ ГАЗА**

				OEM REF.	
<b>BMW</b>					
320i (6 cyl)	82=>	400/640	<b>05.402</b>	35411154285	0,069
323i (6 cyl)	=>82	490/615	<b>05.608</b>	35411121007	0,087
324 D	85=>	580/825	<b>05.403</b>	35411156094	0,084
518 (4 cyl)	=>80	490/680	<b>05.609</b>	35411116090-35411186090	0,083
518 (4 cyl)	82=>	601/822	<b>05.0507</b>	35411154821	•
520 (6 cyl)	=>82	685/835	<b>05.610</b>	35411120358	0,107
520i	83=>	415/640	<b>05.404</b>	35411153859	0,075
520 (4 cyl)	=>80	490/680	<b>05.609</b>	35411116090-35411186090	0,083
520i (6 cyl)	=>82	495/635	<b>05.611</b>	35411116468	0,089
524 TD	85=>	560/845	<b>05.405</b>	35411154508	0,074
525i	81=>93	510/745	<b>05.0251</b>	35411153001	0,098
525i	83=>	415/640	<b>05.404</b>	35411153859	0,075
528i	81=>93	510/745	<b>05.0251</b>	35411153001	0,098
535i-M535i	81=>93	510/745	<b>05.0251</b>	35411153001	0,098

**CITROEN**

Dyane 6/2CV/Acadyane	77=>	610/770	<b>05.345</b>	5491447S	0,059
Mehari	78=>	495/650	<b>05.013</b>	75492414-75492415	0,050
LN-LNA	79=>	475/600	<b>05.575</b>	75492030-75492031	0,054
Visa Special Club (652cc)	79=>	475/600	<b>05.575</b>	75492030-75492031	0,054
Visa Super 1,1	79=>82	690/970	<b>05.576</b>	75492213-75492214	0,024
Visa Super 1,1	82=>84	310/500	<b>05.142</b>	95494610	0,030
Visa 950-1,1	84=>	460/560	<b>05.014</b>	95496866-95600210	0,061
Visa GTI	84=>	1320/1470	<b>05.143</b>	95610422-95605369	0,135
Visa D	84=>	830/1015	<b>05.818</b>	95595357	0,052
AX all (5 cv)	86=>	1180/1320	<b>05.144</b>	95636403	0,125
AX all (6 cv)	87=>	1065/1230	<b>05.145</b>	95636402	0,113
AX 1,0-1,1-1,4 GT (ch. 4193-)	88=>	905/1060	<b>05.015</b>	96016640	0,116
AX D	88=>	985/1110	<b>05.016</b>	96016641	0,111
AX 1,4 (ch. 3949-4192)	08/87=>05/88	850/1030	<b>05.308</b>	96016639	0,133
AX Sport (ch. 4277-)	88=>	1020/1190	<b>05.309</b>	95638604-96060371	0,125
Axel all	85=>	345/560	<b>05.820</b>	95495918	0,051
GS all (Solex carb.)	76=>	475/650	<b>05.695</b>	GX5458422-5490019	0,043
GSA (Weber carb.)	80=>	510/740	<b>05.734</b>	75491096	0,086
GSA (Solex carb.)	80=>	350/560	<b>05.735</b>	75492244	0,046
BX 1,4	82=>	825/1120	<b>05.736</b>	95496078-95496127	0,051

**COMANDI ACCELERATORE A PEDALE - ACCELERATOR CABLES (THROTTLE) - CABLES D'ACCELERATEUR  
VERGASERZUGE - CABLES DE ACELERADOR - CABOS DE ACELERADOR  
LINKI GAZU - LANKA PEDÁLU PLYNU - ТРОСЫ ГАЗА**

				<b>OEM REF.</b>	
---	---	---	--	-----------------	---

<b>CITROEN</b>					
BX 1,6	82=>	1080/1355	<b>05.737</b>	95496079	0,101
BX D	83=>	1230/1440	<b>05.819</b>	95605660	0,086
BX Sport	86=>	1210/1370	<b>05.406</b>	95612286	0,190
CX 2,0-2,2	74=>	620/835	<b>05.347</b>	5463299-75492153	0,059
CX D-Rotodiesel	09/82=>	820/985	<b>05.147</b>	5490877-75492623-75492624	0,082
CX D Bosch	09/82=>	750/860	<b>05.348</b>	5490627	0,096
CX D 2,5	86=>	1015/1105	<b>05.157</b>	95495730	0,142
CX 2,5ie-T	86=>	1415/1640	<b>05.407</b>	95496467	0,278
XM (exc. 24v)	90=>	1510	<b>05.311</b>	96080638	0,270

<b>CITROEN KIT</b>					
AX/BX/CX/C15/ZX/Visa		1714	<b>05.062</b>	162986	0,024
BX/C15/ZX/Visa	08/89=>	1460/1805	<b>05.1156</b>	95656496	0,302
LNA 11/AX	83=>	1550/1805	<b>05.1114</b>	95656497	•
Saxo	97=>	1210/1510	<b>05.0233</b>	1629A7	0,215
Saxo	02=>	1410/1600	<b>05.1139</b>	1629F9	0,312
C1 all 1,0	05=>	1135/1330	<b>05.1103</b>	1629G4	0,244
C3	02=>	1410/1600	<b>05.1139</b>	1629F9	0,312
C5	00=>	2005/2345	<b>05.1157</b>	1629F8	0,222
Xantia	96=>	2490/2677	<b>05.180</b>	1629C6	0,083
Xantia/XM/Xsara/Berlingo	97=>	2500/2710	<b>05.0255</b>	1629E8	0,451
Xsara/Picasso	00=>	2490/2677	<b>05.180</b>	1629C6-1629G0	0,083
Evasion	95=>	1018/1185	<b>05.0005</b>	5894946	0,258

**Voir suivante le dessin - See the following drawing - Der Zeichnen an seite folgend - Siguiente el dibujo**

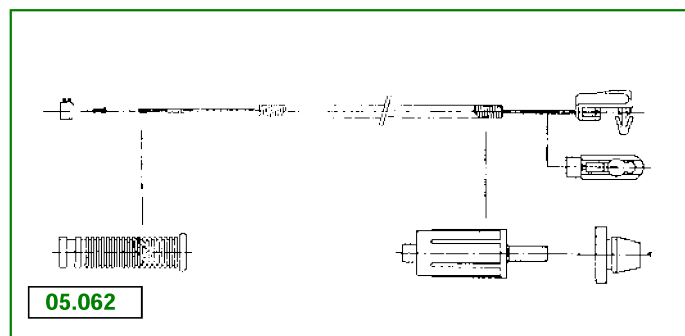
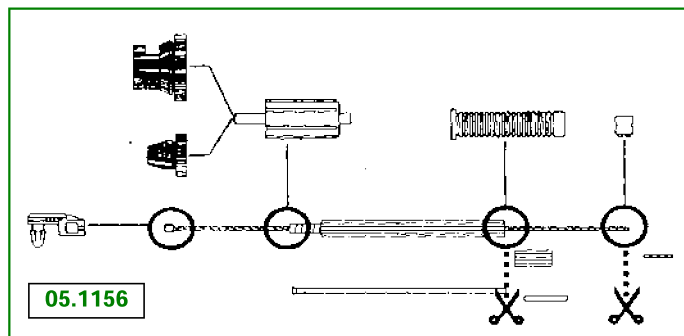



**COMANDI ACCELERATORE A PEDALE - ACCELERATOR CABLES (THROTTLE) - CABLES D'ACCELERATEUR  
VERGASERZUGE - CABLES DE ACELERADOR - CABOS DE ACELERADOR  
LINKI GAZU - LANKA PEDÁLU PLYNU - ТРОСЫ ГАЗА**



OEM REF.

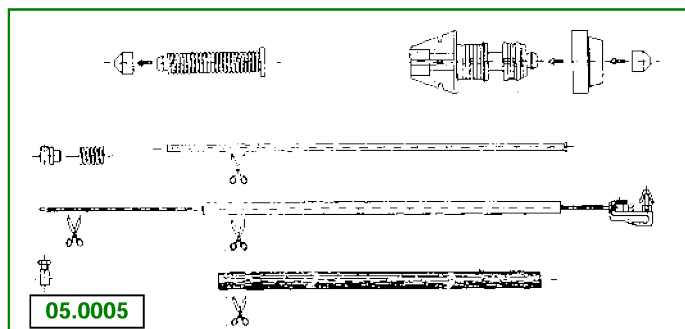
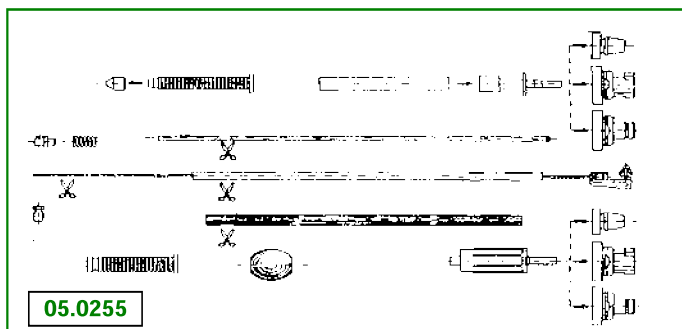
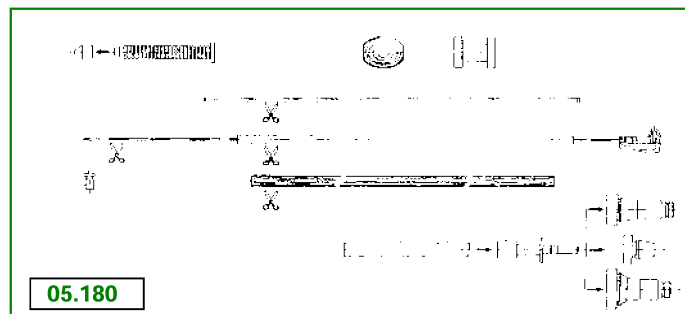
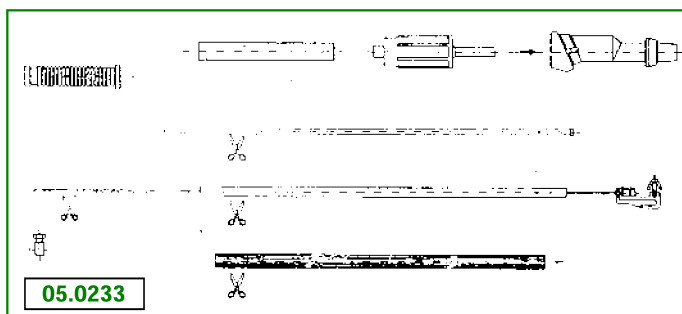

**CITROEN KIT**







**CITROEN - Commercial Vehicle**

C15 D	84=>	830/1015	<b>05.818</b>	95595357	0,052
C15 BZ	88=>	450/560	<b>05.014</b>	95496866-95600210	0,061
C25 BZ	83=>	900/1150	<b>05.567</b>	ZF4477021	0,190
C25 D	83=>	645/780	<b>05.841</b>	ZF05929979	0,148
C25	94=>		<b>05.0195</b>	1629E6	0,478
C25 D		615/770	<b>05.0211</b>	5929982	0,132
C25		960/1030	<b>05.1113</b>	ZF07618342	•
C32-C35 BZ		700/895	<b>05.793</b>	5436394	0,102
C32 D	=>09/80	865/1060	<b>05.295</b>	5441578	0,128
C32-C35 D	10/80=>	1130/1290	<b>05.443</b>	95492680	0,150
Jumper 2.0 BZ	94=>	777/1018	<b>05.0007</b>	1629C0-1305031080	0,211
Jumper 1,9 D-1,9 TD	94=>	921/1107	<b>05.0008</b>	1629D0-1302854080	0,231
Jumper 2,5 D	94=>	950/1150	<b>05.0009</b>	1629D1-1305051080	0,233
Jumper 2,0-1,9 D-2,5 D	94=>		<b>05.0195</b>	1629E6	0,478
Jumper 2,5 TD	94=>	920/1120	<b>05.0273</b>	1629D2-1309896080	0,263

**FERRARI**





246 GT			<b>05.0248</b>	181380	•
308 GTB-GTS			<b>05.0249</b>	106492	•
308 GT			<b>05.0338</b>	120260	•

**COMANDI ACCELERATORE A PEDALE - ACCELERATOR CABLES (THROTTLE) - CABLES D'ACCELERATEUR  
VERGASERZUGE - CABLES DE ACELERADOR - CABOS DE ACELERADOR  
LINKI GAZU - LANKA PEDÁLU PLYNU - ТРОСЫ ГАЗА**





				OEM REF.	
<b>FERRARI</b>					
308			<b>05.0339</b>	105574	•
308			<b>05.0340</b>	115134	•
308			<b>05.0342</b>	137578	•
308 GT4		1045/2345	<b>05.1148</b>	106294	•
328 GTB		1355/2260	<b>05.1147</b>	120498	•
512 BB			<b>05.0341</b>	110809	•
-		1078/2117	<b>05.1146</b>	108355	•

<b>FIAT</b>					
500 all	64=>	860/2140	<b>05.102</b>	4127902-4130875	0,117
500 Giardiniera all	64=>	960/2400	<b>05.104</b>	4127153-4132151	0,120
126 all		860/2140	<b>05.102</b>	4127902-4130875	0,117
126 Bis	87=>	1260/2460	<b>05.181</b>	7557124	0,199
600 (type III)		220/3300	<b>05.106</b>	984814-978721	0,068
600 Multipla (type III)		220/3300	<b>05.106</b>	984814-978721	0,068
600 D	63=>	455/3300	<b>05.108</b>	4130053-4076032-4062360	0,079
850 all	65=>	1015/3300	<b>05.112</b>	4103422-4103425-4127153	0,124
500-126-600-850-900T (unified inner cable)		3300	<b>05.310</b>	4062432-4103422-4130875	0,035
Cinquecento (700cc)	02/92=>	460/640	<b>05.017</b>	7699064	0,111
Cinquecento (900cc)	02/92=>	585/750	<b>05.019</b>	7700305	0,119
Cinquecento (900cc) cat.	02/92=>	490/660	<b>05.022</b>	7700172	0,111
Cinquecento (700cc) cat.	93=>	410/565	<b>05.018</b>	7709408	0,098
Cinquecento Sporting	95=>	685/835	<b>05.0242</b>	46406434	0,108
Seicento (900cc)	02/92=>	490/660	<b>05.022</b>	7700172	0,111
Seicento (1108cc)	03/98=>	685/835	<b>05.0242</b>	46406434	0,108
Seicento (900cc)	98=>	530/708	<b>05.0508</b>	7749741	0,089
Seicento (900cc) Antiskid	03/98=>	540/670	<b>05.0308</b>	46737306	0,094
Seicento (1100cc) Sporting Antiskid	03/98=>	710/850	<b>05.0309</b>	46737307	0,145
Seicento (1100cc) Sporting	00=>	525/760	<b>05.0310</b>	46841644-46557485	•
Panda 30	80=>	485/655	<b>05.333</b>	4414598	0,141
Panda 45	80=>	420/535	<b>05.334</b>	4406533	0,098
Panda 45 Super	10/82=>	650/800	<b>05.589</b>	5960963	0,182
Panda 750-1000-4x4	86=>	720/950	<b>05.900</b>	7562094-7532652-7639374	0,230
Panda D	86=>	560/750	<b>05.901</b>	7583539	0,186
Panda 750 Young	87=>	420/535	<b>05.334</b>	4406533	0,098
Panda 750-1000ie	88=>	700/880	<b>05.408</b>	7618770	0,181
Panda 750-1000-4x4 Fire	90=>	855/735	<b>05.805</b>	7699907-7737766	0,133
Panda 900 Dance	89=>91	650/800	<b>05.589</b>	5960963	0,182
Panda all-Panda 4x4	92=>	560/815	<b>05.1118</b>	46783014	0,086
Panda Dance	92=>93	745/875	<b>05.856</b>	7687765	0,232
Panda Dance-Regimental (cat.)	93=>	505/635	<b>05.852</b>	7739999	0,087





**COMANDI ACCELERATORE A PEDALE - ACCELERATOR CABLES (THROTTLE) - CABLES D'ACCELERATEUR  
VERGASERZUGE - CABLES DE ACELERADOR - CABOS DE ACELERADOR  
LINKI GAZU - LANKA PEDÁLU PLYNU - ТРОСЫ ГАЗА**

				OEM REF.	
<b>FIAT</b>					
Panda 1,1 SPI	93=>94	430/550	<b>05.854</b>	7724754	0,095
Panda 1,1 SPI	94=>	690/825	<b>05.0003</b>	7740732-7760314	0,117
Nuova Panda 1,1-1,2	03=>	605/765	<b>05.1104</b>	46800470-51733652-51739117	0,120
127 (900 cc)	06/77=>	340/410	<b>05.206</b>	4365648	0,053
127 (900 cc) (5 doors)		365/475	<b>05.633</b>	3921303	0,062
127 (900 cc)	10/82=>	820/950	<b>05.631</b>	5932425	0,224
127 (1050 cc)-Sport	06/77=>	530/665	<b>05.205</b>	4364354	0,114
127 Panorama/147 Brazil	81=>	540/665	<b>05.289</b>	4359989	0,130
127-127 Panorama D	81=>	490/685	<b>05.552</b>	4471188-5928954	0,173
Uno 45	83=>	650/800	<b>05.589</b>	5960963	0,182
Uno D all	83=>	580/780	<b>05.621</b>	5970581	0,175
Uno 55-70 all	83=>	1100/1220	<b>05.591</b>	5944272	0,315
Uno 45 (mot. Fire)	05/85=>	880/1120	<b>05.848</b>	7556948	0,268
Uno 60-70 all	85=>	1040/1295	<b>05.844</b>	7563347	0,275
Uno T ie (funne-snodo)	85=>	125	<b>05.419</b>	7565759	•
Uno 1,1-1,3	85=>86	990/1180	<b>05.814</b>	7566908-92322818	0,266
Uno T ie	85=>87	1180	<b>05.590</b>	7551997	0,238
Uno TD	86=>	880/1050	<b>05.166</b>	7596797-7586797	0,260
Uno T ie	87=>	975/1155	<b>05.421</b>	7620591	0,238
Uno Sting	=>89	650/800	<b>05.589</b>	5960963	0,182
Uno 1,4	89=>	460/640	<b>05.315</b>	7656628	0,155
Uno Trend (903 cc)	89=>	650/800	<b>05.589</b>	5960963	0,182
Uno T ie 1,3	89=>	1180	<b>05.590</b>	7551997	0,238
Uno ie 1,4 (Bosch)	89=>	555/650	<b>05.464</b>	7625388	0,160
Uno 1,5ie (Bosch)	88=>	820/940	<b>05.414</b>	7615151	0,228
Uno T ie 1,4	89=>	1075/1325	<b>05.418</b>	7578874	0,316
Uno 1,7 D	89=>	850/1020	<b>05.465</b>	7671678	0,263
Uno CS-Trend (1116cc) (mot. Brasil)	88=>	775/1080	<b>05.926</b>	7606511-7665628	0,229
Uno CS-Top 1,5	=>89	1200	<b>05.040</b>	7509509	0,096
Uno 60/Trend (w/metal)	=>05/90	940/1060	<b>05.0258</b>	7711510-7719939-7719932	0,146
Uno 1,0-1,1 (mot. Fire)	90=>	720/830	<b>05.466</b>	7706323-7748536	0,138
Uno CS	88=>91	660/790	<b>05.560</b>	5963186	0,145
Uno 1,1 (mot. Fire cat.)	92=>	830/1005	<b>05.855</b>	7732285	0,237
Uno Sting (903cc)-Trend	92=>	745/875	<b>05.856</b>	7687765	0,232
Uno D 1,7 all	92=>	785/995	<b>05.0212</b>	7764057	0,262
Premio 1,5	=>89	1200	<b>05.040</b>	7509509	0,096
Punto 55-60-75	11/93=>	700/830	<b>05.857</b>	7736507	0,103
Punto (6 speed)	11/93=>	720/850	<b>05.858</b>	7775116	0,111
Punto GTI	11/93=>	560/720	<b>05.859</b>	7722083	0,191
Punto D	11/93=>	1015/1185	<b>05.860</b>	7739541	0,253
Punto (6 speed)	97=>	630/890	<b>05.0260</b>	7780032	0,116
Punto 55-60-75	97=>	720/880	<b>05.0259</b>	7780024	0,111
Punto 85 1,2 16v	97=>	490/730	<b>05.0261</b>	46473223	0,102
Punto 1,4 Racing	97=>	760/940	<b>05.0262</b>	46467449	0,150
Punto D	97=>	920/1105	<b>05.0263</b>	7780028	0,286
Punto 1,2 8v-Spi	99=>	640/800	<b>05.0509</b>	46749873-46749874	0,159
Punto 1,8 HGT 16v	99=>	696/866	<b>05.0510</b>	46540245	0,115

**COMANDI ACCELERATORE A PEDALE - ACCELERATOR CABLES (THROTTLE) - CABLES D'ACCELERATEUR  
VERGASERZUGE - CABLES DE ACELERADOR - CABOS DE ACELERADOR  
LINKI GAZU - LANKA PEDÁLU PLYNU - ТРОСЫ ГАЗА**

				OEM REF.	
<b>FIAT</b>					
Duna	86=>90	660/790	<b>05.560</b>	5963186	0,145
Duna 60-70	87=>	775/1080	<b>05.926</b>	7606511-7665628	0,229
Duna D	87=>	860/1025	<b>05.925</b>	7588302	0,170
Palio 70 1,2	97=>	820/965	<b>05.0267</b>	46449119-46449120-46470590	0,144
Palio 100 1,6	97=>	230/575	<b>05.0265</b>	46419108	0,068
Palio TD 70	97=>	880/1050	<b>05.0266</b>	46440558	0,282
Palio (extra Europa)	97=>02	875/1025	<b>05.1109</b>	46523140	•
Palio all 1,2	04=>	775/915	<b>05.1105</b>	46740789	0,143
Siena 1,3	04=>	775/915	<b>05.1105</b>	46740789	0,143
Ritmo 60-65 all	=>02/79	280/400	<b>05.221</b>	4392879	0,064
Ritmo 60 L	03/79=>81	510/655	<b>05.424</b>	4394605	0,092
Ritmo all	04/81=>	930/1140	<b>05.446</b>	4479233	0,308
Ritmo 75 (autotrans)	78=>	690/855	<b>05.284</b>	4413988	0,186
Ritmo 60-70	05/85=>	950/1200	<b>05.110</b>	7562689-92322817	0,256
Ritmo 100-105 TC	81=>	550/695	<b>05.550</b>	4468518	0,163
Ritmo 125 TC	81=>	355/485	<b>05.638</b>	4472632	0,102
Ritmo 130 TC Abarth	82=>	710/875	<b>05.630</b>	5981882	0,199
Ritmo 130 TC Abarth (ch. 2836831-)	05/85=>	725/930	<b>05.843</b>	5995379	0,172
Ritmo D all	80=>	720/880	<b>05.440</b>	4431959-5945752	0,221
Ritmo D all	10/82=>	780/945	<b>05.593</b>	5960778	0,236
Ritmo TD	86=>	320/490	<b>05.182</b>	7584158	0,220
X 1/9 (complete)	=>77	770/1980	<b>05.282</b>	4264546-4418706	0,159
X 1/9 (inner only)	=>77	1980	<b>05.367</b>	4264548-4366101-4418706	•
X 1/9 (conduit only)	77=>79	720	<b>05.368</b>	4418708	•
X 1/9	79=>	880/1930	<b>05.287</b>	4425017	0,212
Tipo 1,1	88=>	720/875	<b>05.425</b>	7598787	0,168
Tipo 1,4-1,6	88=>	545/710	<b>05.429</b>	7599345-7715247	0,140
Tipo 1,4 ie	89=>	645/675	<b>05.467</b>	7633255	0,175
Tipo 1,6 ie	89=>	490/670	<b>05.468</b>	7623490	0,164
Tipo 1,6v	89=>	550/660	<b>05.023</b>	7658744	0,167
Tipo D-TD	88=>	890/1065	<b>05.432</b>	7601050	0,239
Tipo D (Cav)	91=>	825/1008	<b>05.316</b>	7658763	0,237
Tipo D-TD (Bosch)	91=>	915/1080	<b>05.318</b>	7697822	0,238
Tempra 1,4-1,6	88=>	545/710	<b>05.429</b>	7599345-7715247	0,140
Tempra 1,4 ie	89=>	645/675	<b>05.467</b>	7633255	0,175
Tempra 1,6 ie	90=>	490/670	<b>05.468</b>	7623490	0,164
Tempra 1,8	90=>	485/610	<b>05.024</b>	7630757	0,099
Tempra D	90=>	890/1065	<b>05.432</b>	7601050	0,239
Tempra TD (Bosch)	91=>	915/1080	<b>05.318</b>	7697822	0,238
Bravo/Brava 1,4 all 12v (80cv)	95=>	470/605	<b>05.0202</b>	46431041	0,092
Bravo/Brava 1,6 (autotrans)	95=>	450/625	<b>05.0203</b>	7776549	0,108
Bravo/Brava 1,8	95=>	1055/1220	<b>05.0204</b>	46446692	0,283
Bravo/Brava D-TD	95=>	845/1045	<b>05.0205</b>	7777663	0,240
Bravo/Brava 1,6	95=>	355/605	<b>05.0214</b>	46463149	0,085

**COMANDI ACCELERATORE A PEDALE - ACCELERATOR CABLES (THROTTLE) - CABLES D'ACCELERATEUR  
VERGASERZUGE - CABLES DE ACELERADOR - CABOS DE ACELERADOR  
LINKI GAZU - LANKA PEDÁLU PLYNU - ТРОСЫ ГАЗА**

				OEM REF.	
<b>FIAT</b>					
Bravo 2,0 20v	95=>	500/695	<b>05.0215</b>	7772034	0,119
Bravo/Brava TD (100cv)	96=>	520/705	<b>05.0200</b>	46469731-46410902	0,193
Bravo/Brava TD (75cv)	96=>	730/910	<b>05.0201</b>	46468658-46475311	0,236
124-124 Special	66=>	250/350	<b>05.118</b>	4162231-4291977	0,040
124 ST 1,6	72=>	550/650	<b>05.123</b>	4291979	0,132
124 Spyder	75=>	300/510	<b>05.026</b>	4354211	0,052
125 Spyder Europa 2,0	82=>	400/600	<b>05.562</b>	4442438	0,129
131 1,3-1,6	=>03/78	425/580	<b>05.131</b>	4322386-4347291	0,070
131 L-CL 1,3-1,6	04/78=>04/81	470/560	<b>05.240</b>	4406514	0,124
131 CL 1,3-1,6	05/81=>	540/710	<b>05.557</b>	4445320	0,149
131 L-CL (autotrans)	78=>	990/1125	<b>05.280</b>	4357123	0,217
131 Supermirafiori 1,3-1,6	09/79=>	1165/1325	<b>05.444</b>	4460586	0,278
131 D (Bosch)	79=>	320/450	<b>05.271</b>	4378341-4473012	0,066
131 D (Cav)	79=>	260/387	<b>05.417</b>	4421015-4473024	0,051
131/Brava/Superbrava (USA mod.)	81=>	430/630	<b>05.563</b>	4441592	0,140
Regata 70-85 1,3-1,5	09/83=>	930/1140	<b>05.446</b>	4479233	0,308
Regata 70 1,3	05/85=>	950/1200	<b>05.110</b>	7562689-92322817	0,256
Regata 85 S 1,6 (82cv)	09/83=>	920/1180	<b>05.622</b>	5955246	0,293
Regata (autotrans)	09/83=>	690/855	<b>05.284</b>	4413988	0,186
Regata 100 1,6	09/83=>85	590/695	<b>05.550</b>	4468518	0,163
Regata 100 1,6 (105cv)	05/85=>	400/570	<b>05.842</b>	7542417	0,140
Regata 1,6ie	87=>	675/875	<b>05.423</b>	7585115	0,228
Regata 1,6 (air cond.)	87=>	990/1180	<b>05.185</b>	92513025-7606109	0,263
Regata 1,6	87=>	965/1250	<b>05.186</b>	7578735-7606108	0,248
Regata 2,0	87=>	480/670	<b>05.188</b>	7606105	0,172
Regata D	09/83=>	780/945	<b>05.593</b>	5960778	0,236
Regata D	85=>	360/525	<b>05.114</b>	7550278	0,112
Regata TD	86=>	860/1030	<b>05.184</b>	7568755	0,214
Regata R/86-TD (air cond.)	87=>	320/490	<b>05.182</b>	7584158	0,220
132 all	=>79	290/410	<b>05.288</b>	4361082-4409438-4357121 4413866	0,050
132 1,6-2,0	80=>	800/990	<b>05.415</b>	4431113	0,203
132 2,0ie	80=>	920/1130	<b>05.416</b>	4441279	0,174
132 D (Bosch)	81=>	450/575	<b>05.274</b>	4414195	0,080
132 D (Cav)	81=>	360/480	<b>05.330</b>	4421010	0,060
Argenta 1,6	81=>	800/990	<b>05.415</b>	4431113	0,203
Argenta 2,0ie	81=>	920/1130	<b>05.416</b>	4441279	0,174
Argenta 2,0 VX	84=>	580/745	<b>05.997</b>	5973415	0,160
Argenta D (Bosch)	81=>	430/550	<b>05.449</b>	4472295-5947342	0,069
Argenta D (Cav)	81=>	335/455	<b>05.448</b>	4472361	0,067
Argenta TD	84=>	375/505	<b>05.117</b>	5964001	0,068
Croma 1,6	01/86=>	665/830	<b>05.909</b>	82412187-82450970	0,162
Croma CHT	01/86=>	830/1120	<b>05.911</b>	82427767-82421616	0,187
Croma CHT	=>88	1235/1410	<b>05.254</b>	82428747	0,232
Croma CHT	88=>	1235/1420	<b>05.433</b>	82439532	0,205

**COMANDI ACCELERATORE A PEDALE - ACCELERATOR CABLES (THROTTLE) - CABLES D'ACCELERATEUR  
VERGASERZUGE - CABLES DE ACELERADOR - CABOS DE ACELERADOR  
LINKI GAZU - LANKA PEDÁLU PLYNU - ТРОСЫ ГАЗА**

				<b>OEM REF.</b>	
---	---	---	--	-----------------	---

**FIAT**

Croma CHT	91=>	1260/1455	<b>05.319</b>	82450872	0,194
Croma ie-T ie	01/86=>	550/695	<b>05.846</b>	82415444-82402398	0,162
Croma ie-T ie	88=>	520/700	<b>05.434</b>	82437904	0,152
Croma 2,0ie	89=>91	465/705	<b>05.862</b>	82446859	0,138
Croma ie-T ie	91=>	960/1180	<b>05.321</b>	82446865	0,211
Croma D-TD	01/86=>	990/1155	<b>05.902</b>	82390039-82427765	0,224
Croma D-TD	87=>	975/1140	<b>05.435</b>	82439691	0,236
Croma D 2,0 ID	88=>	1010/1195	<b>05.437</b>	82444423	0,216
Croma D-TD	88=>	970/1170	<b>05.863</b>	82437902-82448444	0,221
Croma TD 2,5	89=>92	970/1140	<b>05.864</b>	82446863	0,210
Croma D-TD (1930cc)	93=>	1135/1370	<b>05.865</b>	82473850	0,234
Croma D 2,0 ID	93=>	960/1180	<b>05.0004</b>	82484339	0,199
Marea 1,4 all 12v (80cv)	95=>	470/605	<b>05.0202</b>	46431041	0,092
Marea 1,6 16v (103cv)	95=>	355/605	<b>05.0214</b>	46463149	0,085
Marea 1,6 (autotrans)	95=>	450/625	<b>05.0203</b>	7776549	0,108
Marea 1,8	95=>	1055/1220	<b>05.0204</b>	46446692	0,283
Marea 2,0 20v	95=>	500/695	<b>05.0215</b>	7772034	0,119
Marea TD (75cv)	96=>	730/910	<b>05.0201</b>	46468658-46475311	0,236
Marea TD (100cv)	96=>	520/705	<b>05.0200</b>	46469731-46410902	0,193
Marea 1,8	96=>01	945/1125	<b>05.0269</b>	46469068	0,164
Coupé 2,0-2,0 T-2,0 (Brasil motor)	94=>	340/580	<b>05.0268</b>	46412580-46426742	0,112
Coupé 1710 16v (-mot.0331796)	95=>	1055/1220	<b>05.0204</b>	46446692	0,283
Coupé 1710 16v (mot.0331796-)	95=>	945/1125	<b>05.0269</b>	46469068	0,164
Coupé 1750 16v-2,0 16v	96=>	420/615	<b>05.0270</b>	46458212	0,104
Coupé 2,0 20v T	96=>	545/1120	<b>05.0271</b>	46460618	•
Barchetta all	95=>	1126/1406	<b>05.0272</b>	47300129-46724231	0,158
Doblò 1,2 all	01=>	550/750	<b>05.1107</b>	46796027	0,112
Multipla 100 all		485/705	<b>05.0511</b>	46510552	0,130

**FIAT KIT**

Ulysse all	94=>	1018/1185	<b>05.0005</b>	5894946	0,258
------------	------	-----------	----------------	---------	-------

Voir suivante le dessin - See the following drawing - Der Zeichnen an seite folgend - Siguiente el dibujo

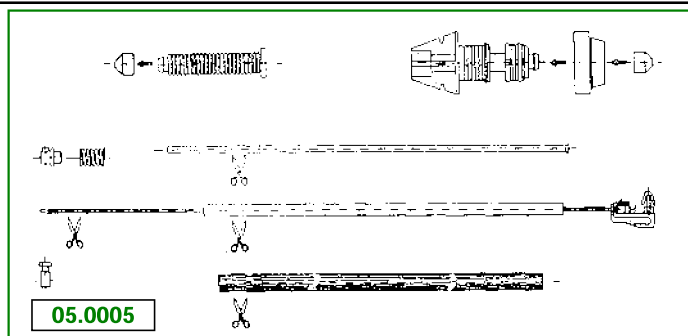

**COMANDI ACCELERATORE A PEDALE - ACCELERATOR CABLES (THROTTLE) - CABLES D'ACCELERATEUR  
VERGASERZUGE - CABLES DE ACELERADOR - CABOS DE ACELERADOR  
LINKI GAZU - LANKA PEDÁLU PLYNU - ТРОСЫ ГАЗА**



OEM REF.



**FIAT - Commercial Vehicle**

600 T/850 T/900 T	63=>	965/3500	<b>05.111</b>	4130996-4059152	0,140
850 T		2615/3760	<b>05.116</b>	4062432-4059161	0,109
Fiorino (900cc)	06/77=>	340/410	<b>05.206</b>	4365648	0,053
Fiorino (1050cc) (Brasil mod.)	81=>	540/665	<b>05.289</b>	4359989	0,130
Fiorino (900cc)	82=>	820/970	<b>05.631</b>	5932425	0,224
Fiorino D	82=>	490/685	<b>05.552</b>	4471188-5928954	0,173
Fiorino (1,1cc)	88=>	660/790	<b>05.560</b>	5963186	0,145
Fiorino 1,3	88=>	775/1080	<b>05.926</b>	7606511-7665628	0,229
Fiorino (1,5cc)	88=>	890/1010	<b>05.580</b>	7616814	0,199
Fiorino D	88=>	860/1025	<b>05.925</b>	7588302-7661142	0,170
Fiorino 1,4-1,6 cat.	93=>	475/595	<b>05.0006</b>	7745824	0,184
Fiorino D (CAV fuel pump)	93=>	780/950	<b>05.0512</b>	7790828	0,222
Fiorino TD	93=>	850/1015	<b>05.0513</b>	50009572-50012521	0,285
Fiorino D 1,3		560/695	<b>05.1115</b>	7657314	•
242 D	=>79	865/1060	<b>05.295</b>	5441578	0,128
242 E D	79=>	1140/1300	<b>05.443</b>	5492679-5492680	0,150
Campagnola D	80=>	310/440	<b>05.329</b>	4436995	0,053
Ducato BZ	81=>	900/1150	<b>05.567</b>	4477021	0,190
Ducato D	81=>	885/1000	<b>05.640</b>	4398035	0,191
Ducato D (Citroen motor)	81=>	635/780	<b>05.841</b>	5929979	0,148
Ducato D-Td	87=>	900/1065	<b>05.584</b>	7594596	0,217
Ducato BZ	94=>	850/1020	<b>05.0007</b>	1305031080	0,211
Ducato D 2,0	94=>	870/1045	<b>05.0008</b>	1300680080	0,231
Ducato D 2,5	94=>	950/1150	<b>05.0009</b>	1305134080	0,233
Ducato D 2,0 (ch. 5057672-)	96=>	920/1120	<b>05.0273</b>	1315770080	0,263
Talento	87=>	900/1065	<b>05.584</b>	7594596	0,217
Talento R90 D	90=>94	900/1065	<b>05.584</b>	7594596	0,217
Talento R90 D	90=>94	900/1150	<b>05.567</b>	4477021	0,190

**FIAT KIT - Commercial Vehicle**

Scudo	96=>	1018/1185	<b>05.0005</b>	5894946	0,258
Ducato	94=>		<b>05.0195</b>	1629E6	0,478

**FIAT IVECO**

Daily/Grinta (Bosch)		890/1090	<b>05.293</b>	93802790	0,216
Daily/Grinta (Cav)		890/1145	<b>05.420</b>	93803172	0,217
Daily/Grinta	85=>	1020/1250	<b>05.917</b>	93803066	0,248
Daily/Grinta 30.8-35.8-40.8	91=>	855/1135	<b>05.227</b>	93813566	0,270
Daily/Grinta 35.10-45.10-49.10	91=>	850/1080	<b>05.229</b>	93810251	0,274

**COMANDI ACCELERATORE A PEDALE - ACCELERATOR CABLES (THROTTLE) - CABLES D'ACCELERATEUR  
VERGASERZUGE - CABLES DE ACELERADOR - CABOS DE ACELERADOR  
LINKI GAZU - LANKA PEDÁLU PLYNU - ТРОСЫ ГАЗА**



OEM REF.



**FIAT IVECO - Commercial Vehicle**

New Daily/Grinta		870/1120	<b>05.0023</b>	93814095	0,310
New Daily/Grinta		860/1050	<b>05.0024</b>	93814089	0,305
OM 40		505/740	<b>05.950</b>	8564018	0,086

**FORD**

Ka	97=>	1420/1560	<b>05.0275</b>	1032225	0,152
Fiesta 900-1,1	76=>	600/735	<b>05.411</b>	6048102-77FB9C799FB-6107734	0,075
Fiesta 1,1	06/89=>	810/960	<b>05.586</b>	6168454-89FB9C799CB	0,086
Fiesta 1,1i	06/89=>	810/910	<b>05.030</b>	6168457-6655074 89FB9C799GA	0,087
Fiesta 1,3	76=>83	870/1060	<b>05.642</b>	6049458-78FB9C799AA	0,102
Fiesta 1,3-XR2 1,6	83=>86	720/920	<b>05.587</b>	6049459-78FB9C799BA	0,104
Fiesta 1,4	86=>89	915/1105	<b>05.588</b>	1640735-86FB9C799	0,115
Fiesta 1,4	06/89=>	1255/1380	<b>05.594</b>	6168458-86FB9C799HA	0,131
Fiesta XR 2i-T	06/89=>	1010/1240	<b>05.031</b>	6197972-89FB9C799LC	0,128
Fiesta D	84=>86	910/1100	<b>05.835</b>	6116226-84FB9C799BA	0,129
Fiesta D	86=>	920/1120	<b>05.927</b>	6159660-86FB9C799EA	0,142
Fiesta D (Cav)	=>89	940/1060	<b>05.032</b>	6168498-89FB9C799VA	•
Fiesta D (Bosch)	89=>	1355/1510	<b>05.0222</b>	6201858	0,193
Fiesta 1,8 D	95=>09/98	1030/1165	<b>05.0246</b>	1018293	•
Fiesta 1,8 D	10/98=>	1030/1155	<b>05.0247</b>	1075712-1149532	•
Escort MK1	=>75	535/670	<b>05.202</b>	1483036	0,054
Escort MK2	75=>80	560/670	<b>05.349</b>	6020567-75AB9C799BA	0,068
Escort MK3/Orion	80=>84	1080/1240	<b>05.644</b>	6068106-81AB9C799AA	0,113
Escort/Orion 1,3-1,6	04/84=>	1045/1185	<b>05.189</b>	6129816-83AB9C799AA	0,143
Escort LX (Brazil mod.)	04/84=>	1250/1380	<b>05.866</b>	3240959	0,085
Escort/Orion D	84=>86	980/1110	<b>05.264</b>	6116223-84AB9C799AA	0,127
Escort/Orion 1,1-1,3	=>86	810/900	<b>05.645</b>	6096579	0,090
Escort/Orion 1,6i	=>86	1940/2040	<b>05.595</b>	1613154-6129815	0,112
Escort 1,6i	86=>	1330/1470	<b>05.596</b>	1634938	0,143
Orion 1,4i-1,6i	86=>	1320/1420	<b>05.597</b>	6159903-86AB9C799AC	0,137
Escort/Orion D	86=>	1020/1120	<b>05.598</b>	1644531-86AB9C799CB 6177044	0,147
Escort/Orion 1,3	09/90=>	850/1022	<b>05.033</b>	6200944-91AB9C799AB	0,104
Escort/Orion 1,4-1,6	09/90=>	1310/1440	<b>05.034</b>	6560809-91AB9C799KB	0,135
Escort/Orion 1,4i	09/90=>	1190/1380	<b>05.035</b>	6608429-91AB9C799JF	0,143
Escort/Orion 1,6i	09/90=>	1160/1310	<b>05.036</b>	1664685-6630810	0,117
Escort/Orion D all (Bosch-Cav)	09/90=>	1555/1710	<b>05.037</b>	6596400-91AB9C799AAC 6624412-91AB9C799HD	0,226
Escort 1,4-1,6	96=>	960/1065	<b>05.0514</b>	6802721	0,112
Escort D	96=>	1555/1725	<b>05.0515</b>	6879711	0,215
Escort TD	96=>	960/1074	<b>05.0516</b>	7317419	0,118
Taurus 1,3	75=>79	575/695	<b>05.279</b>	1569022-6103338	•
Taurus 1,3	79=>	880/1070	<b>05.647</b>	6061800-79BB9C799FA	0,213
Taurus 1,6	79=>	1200/1375	<b>05.646</b>	6061801-79BB9C799GA	0,158
Sierra 1,3-1,6	=>10/82	930/1065	<b>05.741</b>	1610235-6129215	0,156
Sierra 1,6	82=>	1280/1445	<b>05.0276</b>	1634278	0,146

**COMANDI ACCELERATORE A PEDALE - ACCELERATOR CABLES (THROTTLE) - CABLES D'ACCELERATEUR  
VERGASERZUGE - CABLES DE ACELERADOR - CABOS DE ACELERADOR  
LINKI GAZU - LANKA PEDÁLU PLYNU - ТРОСЫ ГАЗА**

				<b>OEM REF.</b>	
---	---	---	--	-----------------	---

<b>FORD</b>					
Sierra 2,0-2,3	=>09/82	415/660	<b>05.743</b>	6129919	0,055
Sierra 2,0-2,3	10/82=>	555/695	<b>05.744</b>	1613178-6154889	0,086
Sierra D	83=>	600/745	<b>05.912</b>	6130797-83GB9C799EB	0,097
Sierra D	87=>	495/645	<b>05.612</b>	6172325	0,079
Sierra 1,8 (motor OHC)	87=>92	1350/1475	<b>05.1121</b>	6157360	0,309
Mondeo D	93=>	1020/1185	<b>05.0025</b>	6898849	0,153
Granada	73=>	615/755	<b>05.738</b>	1535099	0,060
Granada	78=>	740/885	<b>05.654</b>	6062555	0,089
Granada	82=>	740/890	<b>05.655</b>	6107736	0,091



**FORD - Commercial Vehicle**

Transit D	78=>	1310/1465	<b>05.656</b>	1548304	0,229
Transit D	78=>83	1065/1175	<b>05.199</b>	6109399	0,140
Transit D (Simms)	75=>	1070/1200	<b>05.555</b>	1579147-75VB9A758	0,140
Transit D (Bosch)	75=>	1455/1620	<b>05.664</b>	6034657	0,114
Transit D (Bosch)	03/84=>	1010/1170	<b>05.198</b>	6148055-84VB9A758AD	0,152
Transit D	86=>	1220/1335	<b>05.200</b>	6152628-86VB9A758CA	0,174
Transit BZ	86=>	945/1065	<b>05.203</b>	6158183	0,120
Transit D 2,5	86=>	1020/1220	<b>05.0241</b>	6142769	0,139
Transit 190	86=>	945/1065	<b>05.0313</b>	6721491-92VBA758HC	0,095

**HONDA**

Civic all	=>80	930	<b>05.0010</b>	17910664621	0,131
Accord	=>80	1085	<b>05.0011</b>	17910671620	0,153

**INNOCENTI**

Mini Minor/Cooper	65=>	635/810	<b>05.155</b>	38822124-39922108	•
Mini 90-120	76=>	335/465	<b>05.338</b>	538221103	•
Minitre 650	82=>	880/1020	<b>05.138</b>	558300204	0,275
Elba S-Weekend	86=>	660/790	<b>05.560</b>	5963186	0,145
Elba CS	86=>88	1200	<b>05.040</b>	7509509	0,096





**LADA VAZ**

Samara all	86=>	1010/1275	<b>05.045</b>	21081108054	0,189
------------	------	-----------	---------------	-------------	-------

**LANCIA**

A112 all	78=>	285/425	<b>05.217</b>	82337233	0,072
A112 Abarth	78=>	360/500	<b>05.218</b>	82342856	0,056
Y10 Fire 1,0-1,1	03/85=>	600/735	<b>05.804</b>	7532672	0,202
Y10 Touring-T	03/85=>	660/850	<b>05.802</b>	5987925	0,158
Y10 LX ie-4WD ie	89=>	700/880	<b>05.408</b>	7618770	0,181

**COMANDI ACCELERATORE A PEDALE - ACCELERATOR CABLES (THROTTLE) - CABLES D'ACCELERATEUR  
VERGASERZUGE - CABLES DE ACELERADOR - CABOS DE ACELERADOR  
LINKI GAZU - LANKA PEDÁLU PLYNU - ТРОСЫ ГАЗА**

				OEM REF.	
<b>LANCIA</b>					
Y10 1,3	89=>	585/765	<b>05.614</b>	7621081	0,159
Y10 Fire 1,0-1,1	06/90=>	735/855	<b>05.805</b>	7699907-7737766	0,133
Y10	94=>	690/825	<b>05.0003</b>	7760314	0,117
Y 1,2	96=>	700/860	<b>05.0224</b>	46454010	0,111
Y 1,4	96=>	410/590	<b>05.0225</b>	46430821	0,082
Y 1,2 ECVT (TA)	96=>	738/900	<b>05.0280</b>	46454012	•
Y 1,4	97=>	620/800	<b>05.0279</b>	46455495	0,117
Y all	00=>03	540/803	<b>05.1122</b>	46742243	•
Y 1,2	03=>	575/760	<b>05.1108</b>	46813931	•
Y (New)		605/765	<b>05.1104</b>	46800470	0,120
Delta 1,3-1,5	80=>82	1050/1215	<b>05.337</b>	82356324	0,168
Delta 1,6 GT/Prisma 1,6	83=>	860/970	<b>05.722</b>	82384902	0,152
Delta/Prisma 1,3-1,5	86=>	1060/1200	<b>05.207</b>	82426140	0,160
Delta 1,6-2,0-4WD/Prisma 1,6-2,0	86=>	435/640	<b>05.211</b>	82421754	0,148
Delta/Prisma 1,6ie	86=>	690/850	<b>05.214</b>	82427081	0,107
Delta 2,0 4WD 16v	89=>	500/640	<b>05.328</b>	82448036	0,143
Delta TD/Prisma D-TD	85=>	535/670	<b>05.840</b>	82399609	0,183
Delta 1,4-1,6	93=>	520/670	<b>05.0022</b>	7730030	0,105
Delta 1,8	93=>	460/660	<b>05.0191</b>	7744338	0,105
Delta 2,0	93=>	380/580	<b>05.0190</b>	82474154	0,094
Dedra 1,6	89=>90	645/675	<b>05.467</b>	7633255-7652567	0,175
Dedra 1,6	05/90=>	550/680	<b>05.042</b>	7671844-7722753	0,220
Dedra 1,8-2,0	89=>90	485/610	<b>05.024</b>	7630757	0,099
Dedra 1,8-2,0	05/90=>	480/625	<b>05.043</b>	7678198	0,114
Dedra Integrale	05/90=>	470/640	<b>05.327</b>	82467877	0,106
Dedra TD	89=>90	900/1075	<b>05.617</b>	7656666	0,289
Dedra TD	05/90=>	930/1110	<b>05.044</b>	7671848	•
Dedra TD	91	950/1115	<b>05.870</b>	7741734	0,308
Dedra TD	94=>	1000/1180	<b>05.0027</b>	46417995	0,326
Dedra 1,8 16v (115cv)-1,8 16v (132cv)	94=>06/96	1055/1220	<b>05.0204</b>	7777632-46446692	0,283
Dedra 1,8 16v (115cv)-1,8 16v (132cv)	07/96=>01	945/1125	<b>05.0269</b>	46469068	0,164
Fulvia (5 speed)		485/605	<b>05.230</b>	82292541	0,090
Beta (type I)		430/560	<b>05.618</b>	82307920-82310361	0,110
Beta/Trevi all	11/79=>	440/570	<b>05.748</b>	82346111	0,077
Beta/Trevi 2,0ie all	81=>	680/815	<b>05.619</b>	82355703-82387191	0,140
Lybra 1,6	99=>	500/792	<b>05.0517</b>	46524128	0,160
Lybra 1,8	99=>	894/1070	<b>05.0518</b>	46764471	0,158
Thema 2,0ie-T ie	84=>88	550/700	<b>05.846</b>	82402398	0,162
Thema 2,0ie	88=>89	520/700	<b>05.434</b>	82437904	0,152
Thema 2,0ie	89=>	470/705	<b>05.862</b>	82446859	0,138
Thema 2,0 16v	89=>	500/685	<b>05.636</b>	82437900	0,131
Thema 2,8 V6	84=>	1155/1370	<b>05.139</b>	82399762	0,219
Thema TD	84=>86	990/1155	<b>05.902</b>	82390039	0,224
Thema TD	87=>88	975/1140	<b>05.435</b>	82439691	0,236

**COMANDI ACCELERATORE A PEDALE - ACCELERATOR CABLES (THROTTLE) - CABLES D'ACCELERATEUR  
VERGASERZUGE - CABLES DE ACELERADOR - CABOS DE ACELERADOR  
LINKI GAZU - LANKA PEDÁLU PLYNU - ТРОСЫ ГАЗА**

				<b>OEM REF.</b>	
---	---	---	--	-----------------	---

<b>LANCIA</b>					
Thema TD	88=>	1025/1190	<b>05.863</b>	82448444	0,221
Thema TD	89=>	1045/1205	<b>05.864</b>	82446863	0,210
Thema TD	93=>	1140/1370	<b>05.865</b>	82473850	0,234
Thema 2,0 16v	90=>	450/665	<b>05.0028</b>	82446861	0,135
Thema 2,0 16v	92=>	520/765	<b>05.0029</b>	82484204-46415541	0,130
Thema 2,0 16v T	92=>	450/695	<b>05.0142</b>	46415551-82483730	0,135
Kappa 2,0	94=>	590/840	<b>05.0143</b>	60603127	0,120
Kappa T 16v	95=>	495/770	<b>05.0315</b>	7798474	•

<b>LANCIA KIT</b>					
Zeta all	95=>	1018/1185	<b>05.0005</b>	5894946	0,258

**Voir suivante le dessin - See the following drawing - Der Zeichnen an seite folgend - Siguiente el dibujo**

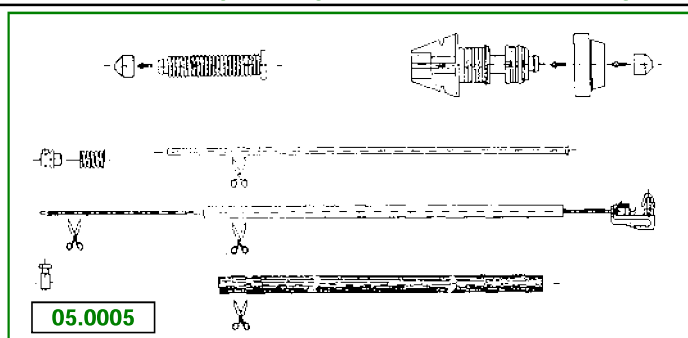

<b>MERCEDES</b>					
200 W 123	83=>	910/1000	<b>05.312</b>	1233002530	0,116
MB 100-130-150		490/655	<b>05.0256</b>	6313000030	0,114
MB 120-140		510/695	<b>05.0257</b>	6313000230	0,210

<b>NISSAN</b>					
Micra 1,0-1,3	93=>	1011/1225	<b>05.0145</b>	182015F200-182015F700 182015F701	0,305
Sunny T 2,0i Abd mod.		1470/1655	<b>05.0316</b>	1820165C00	•
Almera GA14DE-GA16DE	07/95=>	1105/1344	<b>05.0281</b>	182011M200	0,323
Almera CD20	07/95=>	1160/1338	<b>05.0282</b>	1820160J01	•
Almera/Tino		985/1275	<b>05.0317</b>	18201BN000	0,219
Primera 1,6 (GA 16 DS)	91=>	1037/1285	<b>05.0146</b>	1820199J02	0,339
Primera 2,0 (CD 20)	91=>	1165/1330	<b>05.0147</b>	1820199J11	0,360
Primera 2,0 (SR 20 JD1)	91=>	1240/1395	<b>05.0148</b>	1820193J01	0,391
Primera 2,0 GT (SR 20 DE)	91=>	1834/2039	<b>05.0149</b>	1820194J01	0,489
Primera P11		1700/1980	<b>05.0318</b>	182019F610	•
Primera P11 (drum brake)		1110/1345	<b>05.0319</b>	182012F010-182012F070	•
Primera P11 (disc brake)		1780/2030	<b>05.0320</b>	182012F210-182012F270	•
Primera W10-W10 Kombi		1080/1335	<b>05.0321</b>	1820181N00	•
Serena		2800/3000	<b>05.0521</b>	182019C600	•
Serena		2010/2240	<b>05.0522</b>	182019C700	•

**COMANDI ACCELERATORE A PEDALE - ACCELERATOR CABLES (THROTTLE) - CABLES D'ACCELERATEUR  
VERGASERZUGE - CABLES DE ACELERADOR - CABOS DE ACELERADOR  
LINKI GAZU - LANKA PEDÁLU PLYNU - ТРОСЫ ГАЗА**

				<b>OEM REF.</b>	
---	---	---	--	-----------------	---

**NISSAN**

300 ZX		1120/1295	<b>05.0334</b>	1820130P00	•
Pick-Up 620	72=>74	505	<b>05.0231</b>	18200B5500-A8200B5500	•









**NISSAN - Commercial Vehicle**

Vanette		2115/2310	<b>05.0519</b>	18201Y9504	0,313
Vanette		2470/2690	<b>05.0520</b>	18201Y9600	•

**OPEL**





Corsa 1,3 (-ch. 4002669)	11/82=>	570/750	<b>05.665</b>	848854	0,108
Corsa 1,3 (ch. 4002670-)		555/720	<b>05.331</b>	848948-848974	0,107
Corsa 1,0-1,2	11/82=>	570/740	<b>05.332</b>	848713	0,098
Corsa B 1,2-1,4	93=>	645/840	<b>05.876</b>	847061-90411031	0,146
Corsa B 1,4 (82cv)	93=>	570/780	<b>05.877</b>	847065-90411035	0,150
Corsa GSi 1,6	93=>	825/1025	<b>05.878</b>	847067-90448575	0,172
Corsa 1,5 D-TD	93=>	980/1190	<b>05.879</b>	847060-90411040	0,189
Kadett D 1,0-1,2	09/79=>	490/715	<b>05.568</b>	848696	0,096
Kadett D 1,3	09/79=>	340/570	<b>05.666</b>	848695	0,089
Kadett D 1,3 S (ch. 15020305)	09/79=>	315/495	<b>05.569</b>	848694	0,082
Kadett D 1,3 S (autotrans)	09/79=>	335/520	<b>05.679</b>	848832	0,074
Kadett D 1,3 S	09/81=>	310/500	<b>05.672</b>	848698	0,063
Kadett D-E 1,6	09/79=>	825/1020	<b>05.673</b>	848826-848836	0,140
Kadett E 1,2 S OHV-OHC (84-)-Kadett E 1,6	09/81=>	570/770	<b>05.825</b>	848830-848705-90231916 848860	0,096
Kadett E 1,3 S	84=>	570/745	<b>05.824</b>	848964	0,102
Kadett E 1,8ie	84=>	350/505	<b>05.827</b>	848958	0,064
Kadett D-E D	82=>	1010/1220	<b>05.675</b>	848838-848852	0,195
Astra 1,4	09/91=>	560/750	<b>05.967</b>	847022	0,092
Astra 1,4i-1,6i	09/91=>	520/750	<b>05.373</b>	847051	0,106
Astra 1,7 D	09/91=>	970/1240	<b>05.374</b>	847049	0,162
Astra 1,7 TD	92=>	490/700	<b>05.376</b>	847029	0,113
Astra 1,2	98=>	403/671	<b>05.0283</b>	847166-90530802	0,101
Astra 1,4-1,6-1,8-2,0	98=>	362/602	<b>05.0284</b>	847168-90530808	0,211
Astra 1,6 8v (no Italy)	98=>	538/795	<b>05.0285</b>	847172-90530812	0,156
Tigra 1,4	93=>	570/780	<b>05.877</b>	847065-90411035	0,150
Tigra 1,6	93=>	825/1025	<b>05.878</b>	847067-90448575	0,172
Ascona B 1,2	75=>	340/545	<b>05.193</b>	848688	0,090
Ascona B/Manta 1,6		525/720	<b>05.191</b>	848704	0,139
Ascona B/Manta 1,9	75=>	570/750	<b>05.049</b>	848683	0,118
Ascona B/Manta 2,0	76=>	670/900	<b>05.377</b>	848677	0,128
Ascona B D	=>81	570/730	<b>05.574</b>	848685	0,107
Ascona C 1,3	09/79=>	340/570	<b>05.666</b>	848695	0,089
Ascona C 1,3 S	09/81=>	310/500	<b>05.672</b>	848698	0,063

**COMANDI ACCELERATORE A PEDALE - ACCELERATOR CABLES (THROTTLE) - CABLES D'ACCELERATEUR  
VERGASERZUGE - CABLES DE ACELERADOR - CABOS DE ACELERADOR  
LINKI GAZU - LANKA PEDÁLU PLYNU - ТРОСЫ ГАЗА**





				OEM REF.	
<b>OPEL</b>					
Ascona C 1,6	09/81=>	570/770	<b>05.825</b>	848830-848705-90231916	0,096
Ascona C 1,6-1,6 S	09/79=>	825/1020	<b>05.673</b>	848836-848826	0,140
Ascona C D	82=>	1010/1220	<b>05.675</b>	848852-848838	0,195
Omega 1,8-2,0	87=>93	655/895	<b>05.1124</b>	848987-90231928	•
Omega D	87=>93	625/885	<b>05.1125</b>	848988	•
Vectra 1,4-1,6-1,8	88=>	560/750	<b>05.967</b>	847022	0,092
Vectra 1,6-1,8 (cat.)	88=>	580/775	<b>05.966</b>	847018	0,141
Vectra 2,0	88=>	590/780	<b>05.061</b>	847015	0,096
Vectra 2,0ie	88=>	740/995	<b>05.987</b>	847011	0,125
Vectra 1,7 D	88=>	1020/1235	<b>05.047</b>	847007	0,153
Vectra 1,6 16v all	09/95=>	520/710	<b>05.0219</b>	847113-90500196	0,106
Vectra 1,6 8v (SZR mot.)	09/95=>	600/800	<b>05.0220</b>	847100-90500412	0,128
Vectra 1,6 -2,0 8v	09/95=>	540/790	<b>05.0221</b>	847104-90500183	0,114
Vectra 1,8-2,0 16v all	09/95=>	410/645	<b>05.0223</b>	847118-90500187	0,114
Rekord C 1,7		510/725	<b>05.194</b>	848714	0,128
Rekord D 1,7-1,9	77=>	520/750	<b>05.603</b>	848737	0,109
Rekord E 1,8 S		1300/1505	<b>05.811</b>	848944-90190805	0,025
Rekord D 2,0	77=>	485/695	<b>05.604</b>	848740	0,100
Rekord D D		600/755	<b>05.571</b>	848719	0,154
Rekord E		500/710	<b>05.688</b>	848754	0,105
Rekord E 2,0 S		480/700	<b>05.685</b>	848742	0,086
Rekord E D		645/815	<b>05.570</b>	848748	0,124
 					
<b>OPEL - Commercial Vehicle</b>					
Bedford CF (Perkins mot.)		970	<b>05.582</b>	2705198	0,265
Bedford CF (Opel mot.)		250/400	<b>05.583</b>	91050832	0,114

<b>PEUGEOT</b>					
104 all (ex. S/ZX mod.)	84=>	465/590	<b>05.648</b>	162912	0,041
106 all	91=>	1320	<b>05.379</b>	1629A5	•
205 (950cc-1124cc)	83=>	580/775	<b>05.794</b>	163099	0,102
205 GT (XYB mot.)	83=>	280/500	<b>05.798</b>	162901	0,086
205 SR (1360cc)-GTI (XY6B mot.)	83=>	900/1125	<b>05.799</b>	162902-162917	0,150
205 D	84=>	805/980	<b>05.822</b>	162909	0,147
205 1,6	85=>	905/925	<b>05.306</b>	162928	0,133
205 Rally (TU mot.)	87=>	1355/1485	<b>05.653</b>	162972	0,239
205 905-1,1-1,4 (TU24 mot.)	87=>	1010/1030	<b>05.657</b>	162966	0,148
305 all (exc. S-GT)	79=>82	420/530	<b>05.709</b>	163074	0,043
305 S	79=>82	690	<b>05.706</b>	163076	0,045
305 GT	79=>82	1050/1235	<b>05.800</b>	163096	0,163
305 D-Rotodiesel (ch. 8542440)	09/80=>	420/570	<b>05.708</b>	163084	0,037

**COMANDI ACCELERATORE A PEDALE - ACCELERATOR CABLES (THROTTLE) - CABLES D'ACCELERATEUR  
VERGASERZUGE - CABLES DE ACELERADOR - CABOS DE ACELERADOR  
LINKI GAZU - LANKA PEDÁLU PLYNU - ТРОСЫ ГАЗА**

				OEM REF.	
<b>PEUGEOT</b>					
305/304 D (Bosch)	=>07/82	570	<b>05.704</b>	163061	0,041
305 all	83=>	580/915	<b>05.790</b>	163095	0,116
305 1,3-1,5	85=>	670/880	<b>05.712</b>	162934	0,136
305 1,6	85=>	895/915	<b>05.140</b>	162939	0,126
305 D	85=>	880/970	<b>05.216</b>	162935	0,158
309 GL 1,1 (E1 mot.)-GR 1,3 (G1 mot.)	85=>	770/880	<b>05.905</b>	162932	0,102
309 GR-SR 1,6 (XU51C mot.)	85=>	905/925	<b>05.306</b>	162928	0,133
309 GT 1,9 (XU92C mot.)	85=>	1110/1275	<b>05.220</b>	162930	0,163
309 GTI 1,6i	83=>	900/1125	<b>05.799</b>	162902-162917	0,150
309 GT 1,6i	88=>	1275/1420	<b>05.659</b>	162946	0,252
309 D (XUD7 mot.)	84=>	805/980	<b>05.822</b>	162909	0,147
405 GL 1,3	87=>	800/1010	<b>05.660</b>	162957	0,142
405 GL-GR 1,6	87=>	795/990	<b>05.667</b>	162961	0,140
405 GRI-SR 1,9 (without cat.)	87=>	765/985	<b>05.668</b>	162955	0,137
405 GRI-SRI 1,9	87=>	915/1135	<b>05.669</b>	162968	0,188
405 MI 16	87=>	815/1035	<b>05.670</b>	162963	0,129
405 GR-SR 1,9 L	07/88=>	1110/1360	<b>05.0155</b>	162956	0,151
504 GLD	77=>	635/810	<b>05.787</b>	163044	•
505 GL-GR-SR (Solex carb.)	80=>	455/710	<b>05.701</b>	163058	0,045
505 Break (XN1 mot.)	80=>	555/830	<b>05.786</b>	163093	0,048
505 TI	80=>	780/990	<b>05.699</b>	163060	0,048
505 GR-SR 1,8	85=>	1360/1680	<b>05.232</b>	162931	0,126
505 TI-STI-T	85=>	530/770	<b>05.233</b>	162904	0,040
505 D (Bosch)	80=>	565/765	<b>05.700</b>	163064-163078	0,042
505 D-Rotodiesel	80=>	555/730	<b>05.788</b>	163066	0,044
505 D (Bosch)	85=>	1365/1645	<b>05.234</b>	163079-163068	0,441
<b>PEUGEOT KIT</b>					
104/204/304/404		985/1150	<b>05.212</b>	163037-164434-164708	•
104		1365/1645	<b>05.624</b>	163068	0,032
104	83=>	1714	<b>05.062</b>	162986	0,024
104 all		1500/1650	<b>05.0343</b>	-	•
104	83=>		<b>05.1140</b>	-	•
106/307/605/807/Partner/Ranch	96=>	2500/2710	<b>05.0255</b>	1629E8	0,451
106 all	96=>	1210/1510	<b>05.0233</b>	1629A7	0,215
106		2490/2677	<b>05.180</b>	1629C6	0,083
106	02=>	1410/1600	<b>05.1139</b>	1629F9	0,312
107 all	05=>	1135/1330	<b>05.1103</b>	1629G4	0,244
205		1714	<b>05.062</b>	162986	0,024
205			<b>05.1140</b>	-	•
206		2490/2677	<b>05.180</b>	1629C6	0,083
206	96=>	2500/2710	<b>05.0255</b>	1629E8	0,451

**COMANDI ACCELERATORE A PEDALE - ACCELERATOR CABLES (THROTTLE) - CABLES D'ACCELERATEUR  
 VERGASERZUGE - CABLES DE ACELERADOR - CABOS DE ACELERADOR  
 LINKI GAZU - LANKA PEDÁLU PLYNU - ТРОСЫ ГАЗА**

				OEM REF.	
<b>PEUGEOT KIT</b>					
305 XU		1714	<b>05.062</b>	162986	0,024
305 XU			<b>05.1140</b>	-	•
306 all	94=>	1790/1995	<b>05.0154</b>	1629C5-1629E7	0,492
306	96=>	2500/2710	<b>05.0255</b>	1629E8	0,451
309		1714	<b>05.062</b>	162986	0,024
309			<b>05.1140</b>	-	•
405		1714	<b>05.062</b>	162986	0,024
405	94=>	1430/1660	<b>05.0159</b>	1629C3	0,285
405			<b>05.1140</b>	-	•
406 all	95=>	2490/2677	<b>05.180</b>	1629C6	0,083
504		985/1150	<b>05.212</b>	163037-164434-164708	•
504		1365/1645	<b>05.624</b>	163068	0,032
505 (exc. D)		1500/1650	<b>05.0343</b>	-	•
505		1365/1645	<b>05.624</b>	163068	0,032
604		985/1150	<b>05.212</b>	163037-164434-164708	•
604		1365/1645	<b>05.624</b>	163068	0,032
806 all	95=>	1018/1185	<b>05.0005</b>	1629D7	0,258

**Voir suivante le dessin - See the following drawing - Der Zeichnen an seite folgend - Siguiente el dibujo**

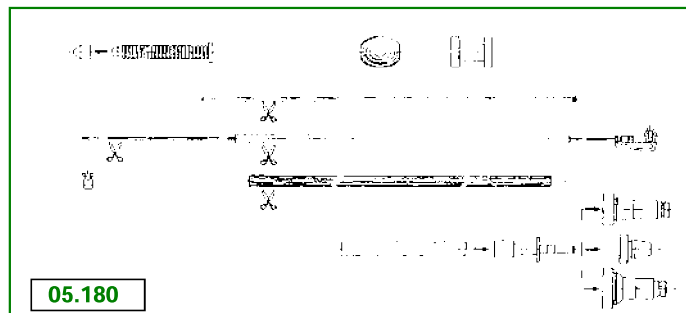
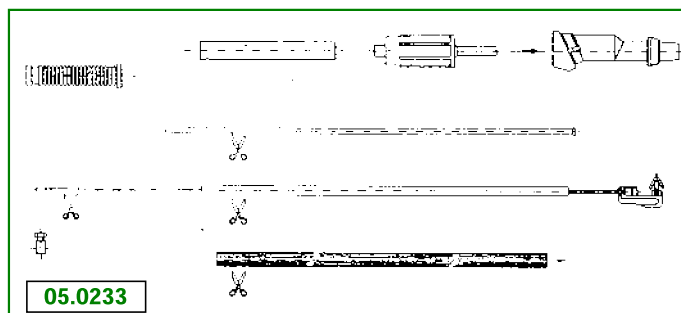
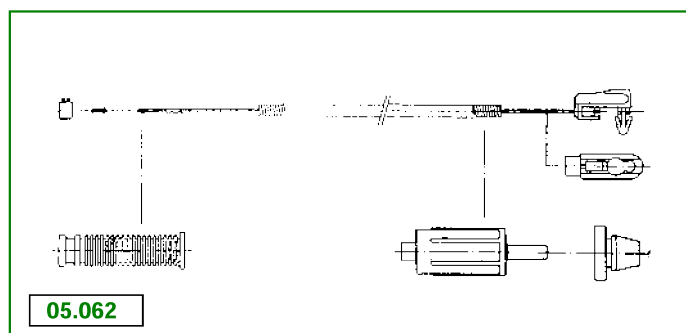
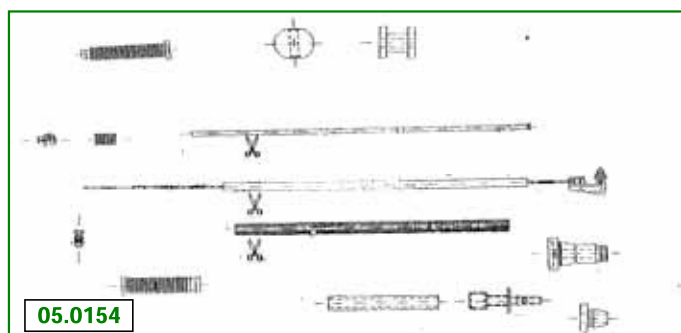



**COMANDI ACCELERATORE A PEDALE - ACCELERATOR CABLES (THROTTLE) - CABLES D'ACCELERATEUR  
VERGASERZUGE - CABLES DE ACELERADOR - CABOS DE ACELERADOR  
LINKI GAZU - LANKA PEDÁLU PLYNU - ТРОСЫ ГАЗА**



OEM REF.

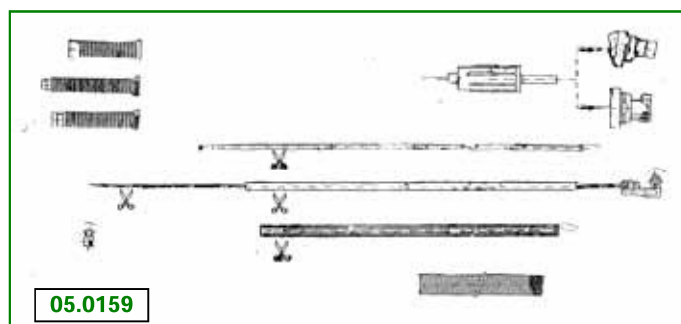
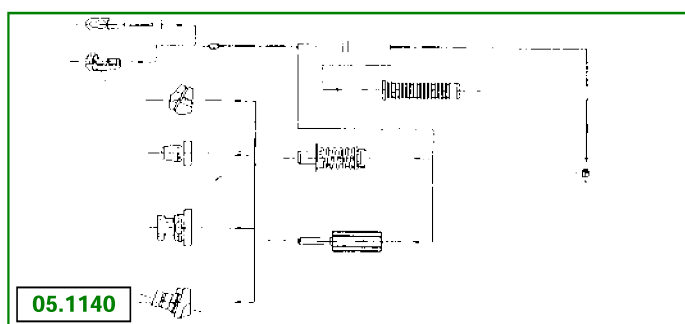
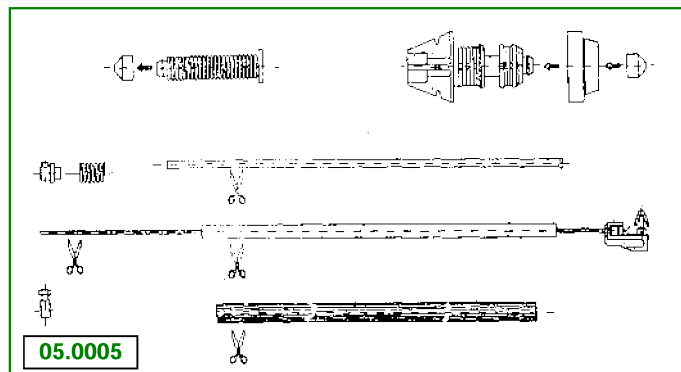
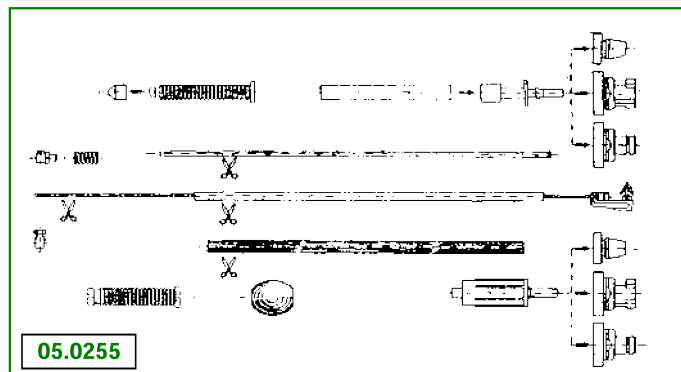

**PEUGEOT KIT**



**PEUGEOT - Commercial Vehicle**

J7-J9		985/1150	<b>05.212</b>	163037-164434-164708	•
J7-J9		1365/1645	<b>05.624</b>	163068	0,032
J5	83=>	900/1150	<b>05.567</b>	163091	0,190
J5 D	83=>	635/775	<b>05.841</b>	163090	0,148
Boxer 2,0 BZ	94=>	777/1018	<b>05.0007</b>	1629C9-1305031080	0,211
Boxer 1,9 D-TD	94=>	870/1045	<b>05.0008</b>	1629D0-1302854080	0,231
Boxer 2,5 D	94=>	950/1150	<b>05.0009</b>	1629D1-1305051080 1305134080	0,233
Boxer 2,5 TD	94=>	920/1120	<b>05.0273</b>	1629D2-1309896080 1315770080	0,263





**PEUGEOT KIT - Commercial Vehicle**

J5	94=>		<b>05.0195</b>	1629E6	0,478
Boxer	94=>		<b>05.0195</b>	1629E6	0,478





**POLSKI**

126 P		860/2140	<b>05.102</b>	4127902-4130875	0,117
126 Bis	87=>	1260/2460	<b>05.181</b>	7557124	0,199
Polonez 1,3-1,5		880/1060	<b>05.556</b>	4389184	0,195



**COMANDI ACCELERATORE A PEDALE - ACCELERATOR CABLES (THROTTLE) - CABLES D'ACCELERATEUR  
VERGASERZUGE - CABLES DE ACELERADOR - CABOS DE ACELERADOR  
LINKI GAZU - LANKA PEDÁLU PLYNU - ТРОСЫ ГАЗА**

				OEM REF.	
<b>RENAULT</b>					
R4	=>70	460/840	<b>05.163</b>	0855675800	0,026
R4	70=>74	440/790	<b>05.164</b>	7701348066	0,021
R4 L-GTL	75=>	220/500	<b>05.165</b>	7701348381-7700525564	0,029
R4 GTL	76=>	510/920	<b>05.426</b>	7700625845-7701348617	0,030
R4 L-TL	84=>	685/1095	<b>05.828</b>	7700755025	0,029
R4 GTL	84=>	550/1010	<b>05.829</b>	7700755027-7701349814	0,051
Twingo	93=>	1020/1260	<b>05.0160</b>	7700823051	0,112
Twingo	95=>	1020/1275	<b>05.0323</b>	7700847796	0,103
R5 L-TL-GTL	75=>	670/1010	<b>05.169</b>	7700584431-7701348134	0,097
R5 Alpine		550/820	<b>05.625</b>	7701348657	0,036
Supercinque	82=>	690/900	<b>05.752</b>	7701349422	0,077
Supercinque	83=>	800/970	<b>05.817</b>	7704001782	0,089
R6	76=>	220/500	<b>05.165</b>	7701348381-7700525564	0,029
Clio 1,1	91=>	745/760	<b>05.380</b>	7700802684	0,107
Clio 1,2	91=>	940/1215	<b>05.381</b>	7700802693	0,147
Clio 1,4	91=>	945/1265	<b>05.065</b>	7700814767	0,164
Clio 16v	92=>	740/755	<b>05.382</b>	7700802691	0,092
Clio 1,7 (exc.Italy)	91=>	980/1250	<b>05.965</b>	7700802690	0,198
Clio D	91=>	755/955	<b>05.389</b>	7700802692-7700831505	0,139
Clio 1,2	98=>	436/693	<b>05.0291</b>	7700427379-7700416622	0,079
Clio 1,4-1,6	98=>	475/938	<b>05.0292</b>	7700429598	0,149
Clio 1,9 D	98=>	535/1122	<b>05.0293</b>	7700429400-7700425600	0,178
R9 all	=>82	480/720	<b>05.750</b>	7704001509	0,090
R9 GTS-TSE	81=>	390/515	<b>05.678</b>	7704001513	0,181
R9	82=>	690/900	<b>05.752</b>	7701349422	0,077
R9 (Colombia/South America mod.)		1060	<b>05.0500</b>	7700763232	0,117
R9 D	83=>	800/970	<b>05.817</b>	7704001782	0,089
R11	82=>	690/900	<b>05.752</b>	7701349422	0,077
R11 (Colombia/South America mod.)		1060	<b>05.0500</b>	7700763232	0,117
R11 D	83=>	800/970	<b>05.817</b>	7704001782	0,089
R12	=>74	725/1010	<b>05.172</b>	7700544065-7701348072	0,125
R12	75=>	710/890	<b>05.427</b>	7700630601-7700637536	0,082
R18 L-TL (1400cc)	77=>	480/730	<b>05.629</b>	7700641401	0,087
R18 GTS (1600cc)	77=>	460/645	<b>05.566</b>	7700641399	0,077
R18 GTS 1,6 (5 speed)	82=>	420/670	<b>05.236</b>	7700688117	0,070
R18 D/Fuego D-TD	82=>	720/900	<b>05.826</b>	7704002293	0,136
R18/Fuego		1120/1390	<b>05.564</b>	7701348894	0,137
R19 TL-TS-TSE	88=>	1050/1370	<b>05.671</b>	7700789191	0,161
R19 TXE	88=>	1135/1360	<b>05.681</b>	7700787473	0,164
R19 Chamade GTX-TXE	09/90=>	925/1220	<b>05.390</b>	7700806995	0,143
R19 1,4i	92=>	940/1290	<b>05.0162</b>	7700813980	0,146

**COMANDI ACCELERATORE A PEDALE - ACCELERATOR CABLES (THROTTLE) - CABLES D'ACCELERATEUR  
VERGASERZUGE - CABLES DE ACELERADOR - CABOS DE ACELERADOR  
LINKI GAZU - LANKA PEDÁLU PLYNU - ТРОСЫ ГАЗА**

				OEM REF.	
<b>RENAULT</b>					
R19 1,7i	92=>	455/755	<b>05.0163</b>	7700271055	0,072
R19 1,8i	92=>	1055/1295	<b>05.0164</b>	7700815820	0,161
R19 16v	92=>	505/765	<b>05.392</b>	7700790104	0,085
R19 TBD-TDX	91=>	785/985	<b>05.394</b>	7700812042	0,123
Megane 1,4	96=>	1000/1365	<b>05.0294</b>	7700843189	•
Megane 1,6 Coach-Scenic	96=>	760/970	<b>05.0295</b>	7700843190	0,096
Megane 2,0 Coach-Scenic	96=>	790/995	<b>05.0296</b>	7700843194	0,096
Megane D-TD-Scenic	96=>	820/1020	<b>05.0297</b>	7700843197	0,145
R20 D		1000	<b>05.0234</b>	7700701436	0,122
R21 TL-TS-GTS-RS-TSE	86=>	385/610	<b>05.244</b>	7700765884-7700783394	0,056
R21 TXE-RX	86=>	680/970	<b>05.245</b>	7700765885	0,073
R21		1035/1330	<b>05.0235</b>	7700797422	0,134
Laguna 1,8 (56A-S)	94=>	963/1210	<b>05.0167</b>	7700824077	0,149
Laguna 2,0 (56C-H-N)	94=>	302/501	<b>05.0168</b>	7700825601	0,068
Laguna TD	94=>	1372/1568	<b>05.0169</b>	7700824071	0,241
R25 GTS	84=>	850/1210	<b>05.068</b>	7700767945	0,131
R25 D	84=>	800/945	<b>05.246</b>	7700759758	0,134
R25 V6	84=>	900/1190	<b>05.0237</b>	7700759761	0,095
Safrane RN-RT 2,0-2,2ie	92=>	970/1300	<b>05.0170</b>	7700813928	0,147
Safrane RXE	92=>	975/1245	<b>05.0238</b>	7700813982	0,152
Safrane D 2,5	92=>	1440/1675	<b>05.0173</b>	7700813985	0,206
Safrane DT		1450/1670	<b>05.0324</b>	7700834530	0,255
Espace all	=>85	690/960	<b>05.906</b>	6025000129	•
Espace all	85=>	680/950	<b>05.260</b>	6025002330	0,108
Espace D	84=>	610/755	<b>05.907</b>	6025002332	0,084
<b>RENAULT KIT</b>					
R4 all	=>84	770/1100	<b>05.150</b>	7701349843	0,036
R5		1305/1560	<b>05.064</b>	7701349815	0,082
Supercinque		1305/1560	<b>05.064</b>	7701349815	0,082
Clio		1305/1560	<b>05.064</b>	7701349815	0,082
Clio	=>97		<b>05.0290</b>	-	0,249
Clio	98=>	1310/1560	<b>05.0299</b>	7700844461	0,239
Twingo			<b>05.0290</b>	-	0,249
Twingo 1149-1239cc	95=>	1310/1560	<b>05.0299</b>	7700844461	0,239
R9		1305/1560	<b>05.064</b>	7701349815	0,082
R11		1305/1560	<b>05.064</b>	7701349815	0,082

**COMANDI ACCELERATORE A PEDALE - ACCELERATOR CABLES (THROTTLE) - CABLES D'ACCELERATEUR  
VERGASERZUGE - CABLES DE ACELERADOR - CABOS DE ACELERADOR  
LINKI GAZU - LANKA PEDÁLU PLYNU - ТРОСЫ ГАЗА**

				OEM REF.	
<b>RENAULT KIT</b>					
R12		1010/1400	<b>05.565</b>	7701348890	0,144
R14		1010/1400	<b>05.565</b>	7701348890	0,144
R15		1010/1400	<b>05.565</b>	7701348890	0,144
R17		1010/1400	<b>05.565</b>	7701348890	0,144
R18		1305/1560	<b>05.064</b>	7701349815	0,082
R19		1305/1560	<b>05.064</b>	7701349815	0,082
R19			<b>05.0290</b>	-	0,249
Megane		1310/1560	<b>05.0299</b>	7700844461	0,239
Fuego		1305/1560	<b>05.064</b>	7701349815	0,082
Laguna		1310/1560	<b>05.0299</b>	7700844461	0,239
R20		1010/1400	<b>05.565</b>	7701348890	0,144
R21		1305/1560	<b>05.064</b>	7701349815	0,082
R25		1305/1560	<b>05.064</b>	7701349815	0,082
R30		1010/1400	<b>05.565</b>	7701348890	0,144
Safrane			<b>05.0290</b>	-	0,249
Espace		1305/1560	<b>05.064</b>	7701349815	0,082
Espace			<b>05.0290</b>	-	0,249
Express BZ	85=>91	1305/1560	<b>05.064</b>	7701349815	0,082
Express BZ	91=>		<b>05.0290</b>	-	0,249
Trafic P/AR D	07/85=>	1305/1560	<b>05.064</b>	7701349815	0,082

**Voir suivante le dessin - See the following drawing - Der Zeichnen an seite folgend - Siguiente el dibujo**

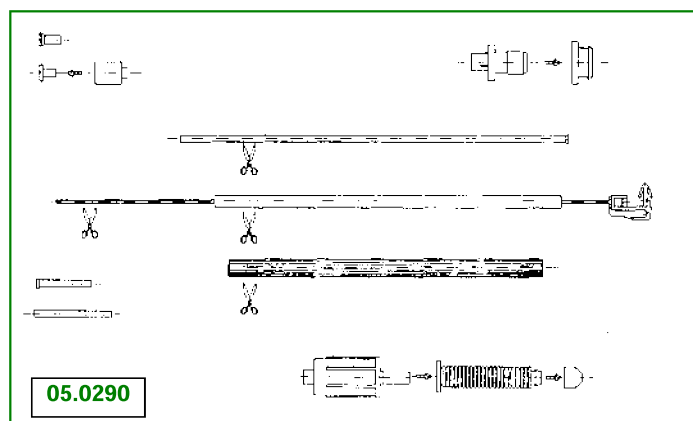
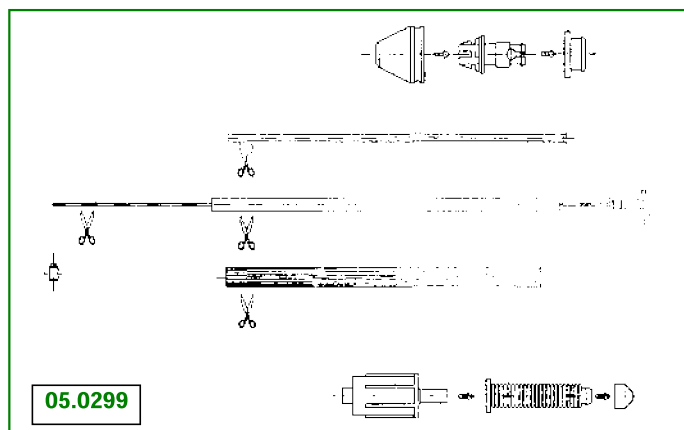

**COMANDI ACCELERATORE A PEDALE - ACCELERATOR CABLES (THROTTLE) - CABLES D'ACCELERATEUR  
VERGASERZUGE - CABLES DE ACELERADOR - CABOS DE ACELERADOR  
LINKI GAZU - LANKA PEDÁLU PLYNU - ТРОСЫ ГАЗА**



OEM REF.



**RENAULT KIT**

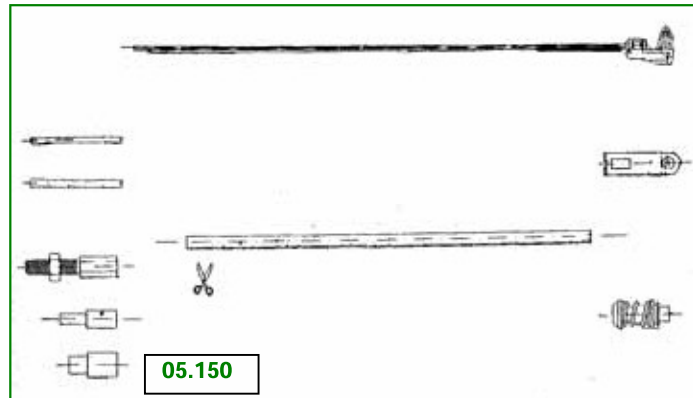
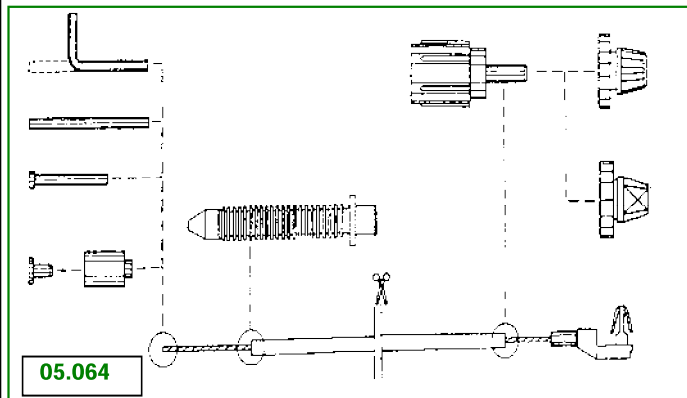

**RENAULT - Commercial Vehicle**

R4 Cargo	70=>74	440/790	<b>05.164</b>	7701348066	0,021
R4 Cargo	75=>	220/500	<b>05.165</b>	7701348381-7700525564	0,029
R4 Cargo F6	76=>	510/920	<b>05.426</b>	7700625845-7701348617	0,030
R4 Cargo F4	84=>	685/1095	<b>05.828</b>	7700755025	0,029
R4 Cargo F6	84=>	550/1010	<b>05.829</b>	7700755027-7701349814	0,051
Express	82=>	690/900	<b>05.752</b>	7701349422	0,077
Express D	83=>	800/970	<b>05.817</b>	7704001782	0,089
Kangoo 1,2	98=>	436/696	<b>05.0291</b>	7700427379-7700416622	0,079
Kangoo 1,4	98=>	475/938	<b>05.0292</b>	7700429598-7700416623	0,149
Kangoo 1,9 D	98=>	535/1122	<b>05.0293</b>	7700429400-7700425600	0,178
Trafic (mot. 847)	81=>	690/900	<b>05.752</b>	7701349422	0,077
Trafic D (mot. 852-2068cc)	81=>	1190/1340	<b>05.832</b>	7704002206	0,169
Trafic D (mot. SBU-2445cc)	81=>	805/975	<b>05.099</b>	7704002210	•
Trafic TR 2,1 D (mot. 829)	81=>	1250/1450	<b>05.807</b>	7701349423-7701388321	0,130
Master PR-AR D	81=>	1760	<b>05.175</b>	5000387500	0,0167
Master TR 2,4-2,5 D	86=>03/89	1610/1785	<b>05.457</b>	5000394950	0,083
Master TR 2,4-2,5 D	04/89=>	1670/1770	<b>05.458</b>	7700732603	0,073





**RENAULT DACIA**

Logan BZ	04=>	680/950	<b>05.1110</b>	8200215959-6001546868	0,108
----------	------	---------	----------------	-----------------------	-------

**ROVER**

Mini all		635/810	<b>05.155</b>	21A2445	0,063
Mini Cooper		470/800	<b>05.868</b>	39922108	0,056
Metro	81=>85	550/740	<b>05.745</b>	FAM8697	0,059
Metro	85=>	610/840	<b>05.215</b>	FAM8698-NAM2978	0,054





**COMANDI ACCELERATORE A PEDALE - ACCELERATOR CABLES (THROTTLE) - CABLES D'ACCELERATEUR  
VERGASERZUGE - CABLES DE ACELERADOR - CABOS DE ACELERADOR  
LINKI GAZU - LANKA PEDÁLU PLYNU - ТРОСЫ ГАЗА**

				OEM REF.	
<b>ROVER</b>					
Allegro 1,1-1,3	76=>	685/850	<b>05.746</b>	FAM8981	0,066
Marina 1,3-D		465/600	<b>05.782</b>	CHM49	0,052
<b>LANDROVER</b>					
Range Rover	70=>86	420/610	<b>05.847</b>	577356	0,057
Land Rover		320/500	<b>05.747</b>	598852	0,046

<b>SAAB</b>					
99 (900)	75=>	550/810	<b>05.914</b>	8315624	•
900	79=>85	480/790	<b>05.916</b>	8335986	•
900ie	79=>85	485/760	<b>05.922</b>	8339996	0,161

<b>SEAT</b>					
Panda 30-45		420/535	<b>05.334</b>	X04406533	0,098
Marbella		650/780	<b>05.364</b>	X039625440-SE141110501A	0,165
Marbella		645/795	<b>05.103</b>	X03960300	0,123
127 CL		365/475	<b>05.633</b>	HH11006201	0,062
127 Fura		820/950	<b>05.631</b>	X039350920	0,224
Arosa 1,0 (AHT mot.)	=>98	372/625	<b>05.0179</b>	6N1721555A-6X1721555A	0,158
Arosa 1,0 (AHW-AK mot.)	98=>	1331/1602	<b>05.0300</b>	6N1721555N-6N1721555P	0,215
Arosa 1,4	98=>	335/608	<b>05.0301</b>	6N1721555K	0,076
Ibiza D		690/855	<b>05.853</b>	X039390870	0,147
Ibiza D		560/875	<b>05.682</b>	X039528870	0,154
Ibiza D		630/780	<b>05.0302</b>	SE022110501A	0,181
Ibiza BZ	=>92	760/885	<b>05.0530</b>	X039546970	0,051
Ibiza D	=>92	695/865	<b>05.690</b>	X039613470	0,158
Ibiza 1050-1,3 all	93=>	800/1080	<b>05.0174</b>	1H0721555	0,125
Ibiza 1,4i-1,6i	94=>	950/1190	<b>05.0179</b>	6N1721555A	0,158
Ibiza 1,6-1,8	93=>	565/760	<b>05.496</b>	1H0721555A-1H0721555J	0,110
Ibiza D	95=>	682/940	<b>05.1100</b>	1H0721555G-1H0721555Q	0,125
Ibiza D	93=>	705/890	<b>05.497</b>	1H0721555B	0,106
Ibiza Junior (903cc)		480/625	<b>05.0523</b>	SE021110501B-X039546170	0,109
Ibiza 1,2		255/370	<b>05.0524</b>	SE021110501C-X03949848	0,044
Ibiza 1,5		245/390	<b>05.0325</b>	SE021110501A-X03946698	0,045
Ibiza 1,0	95=>	373/635	<b>05.0525</b>	6K0721555B	0,087
Cordoba 1,6-1,8 all	93=>	565/760	<b>05.496</b>	1H0721555A-1H0721555J	0,110
Cordoba D	93=>	705/890	<b>05.497</b>	1H0721555B	0,106
Cordoba	94=>		<b>05.0179</b>	6N1721555A	0,158
Cordoba D 1,9	95=>	682/940	<b>05.1100</b>	1H0721555G-1H0721555Q	0,125
124 D-LS		250/355	<b>05.118</b>	EA11008400	0,040
131 (1430cc)		390/495	<b>05.760</b>	JA11050100	0,065

**COMANDI ACCELERATORE A PEDALE - ACCELERATOR CABLES (THROTTLE) - CABLES D'ACCELERATEUR  
VERGASERZUGE - CABLES DE ACELERADOR - CABOS DE ACELERADOR  
LINKI GAZU - LANKA PEDÁLU PLYNU - ТРОСЫ ГАЗА**

				OEM REF.	
<b>SEAT</b>					
Malaga D		690/855	<b>05.853</b>	X039390870	0,147
Malaga D		560/875	<b>05.682</b>	X039528870	0,154
Malaga D		630/780	<b>05.0302</b>	SE022110501A	0,181
Malaga BZ	=>92	760/885	<b>05.0530</b>	X039546970	0,051
Malaga D	=>92	695/865	<b>05.690</b>	X039613470	0,158
Malaga 1,2		255/370	<b>05.0524</b>	SE021110501C-X03949848	0,044
Malaga 1,5		245/390	<b>05.0325</b>	SE021110501A-X03946698	0,045
Ritmo D		790/880	<b>05.440</b>	X044319590	0,221
Ronda D		690/855	<b>05.853</b>	X039390870	0,147
Ronda D		560/875	<b>05.682</b>	X039528870	0,154
Ronda D		630/780	<b>05.0302</b>	SE022110501A	0,181
Ronda 1,2		255/370	<b>05.0524</b>	SE021110501C-X03949848	0,044
Ronda 1,2		880/1070	<b>05.836</b>	X039352490	0,223
Ronda 1,5		245/390	<b>05.0325</b>	SE021110501A-X03946698	0,045
Ronda 1,5		550/695	<b>05.550</b>	X044685180	0,163
Toledo 1,6-1,8 (-ch.1LZZD309350)	91=>	865/1055	<b>05.689</b>	171721555T	0,140
Toledo			<b>05.1103</b>	1L0721555G	•
Toledo1,6-1,8 (ch. 1LZZD309351-)		900/1170	<b>05.1102</b>	1L0721555A	0,146
Toledo 1,9-TDS	91=>	725/920	<b>05.388</b>	171721555L	0,110
Toledo 1,6	11/96=>	565/770	<b>05.1129</b>	3A1721555B	•
Toledo 1,8-2,0 (mot.Eng.)	91=>	565/770	<b>05.1129</b>	3A1721555B	•







**SEAT - Commercial Vehicle**

Terra		645/795	<b>05.103</b>	X03960300	0,123
Terra D		1030/1160	<b>05.469</b>	X039616670	0,154

**SKODA**

105-110-120 (inner only)		4015	<b>05.486</b>	113904020	0,036
105-120 (inner only)		3250	<b>05.0178</b>	630522740	•
Favorit		600/770	<b>05.0239</b>	115522740	0,096
Favorit (new model)		600/775	<b>05.0303</b>	115522747	0,098
Favorit 1,3 MPI		905/1085	<b>05.0326</b>	6U0721555A	0,127
Favorit Monotronic		890/1115	<b>05.0327</b>	6U0721555C	0,129
Favorit (inner only)		1100	<b>05.0330</b>	6U0721557D	•
Felicia 1,3 MPI		905/1085	<b>05.0326</b>	6U0721555A	0,127
Felicia Monotronic		890/1115	<b>05.0327</b>	6U0721555C	0,129
Felicia (inner only)		1100	<b>05.0330</b>	6U0721557D	•
Felicia 1,6		455/665	<b>05.0328</b>	6U0721555B	•
Felicia 1,9 D		790/1010	<b>05.0329</b>	6U0721555	0,123

**COMANDI ACCELERATORE A PEDALE - ACCELERATOR CABLES (THROTTLE) - CABLES D'ACCELERATEUR  
VERGASERZUGE - CABLES DE ACELERADOR - CABOS DE ACELERADOR  
LINKI GAZU - LANKA PEDÁLU PLYNU - ТРОСЫ ГАЗА**

				OEM REF.	
<b>SUBARU</b>					
Justy 1,0-1,2		520/750	<b>05.0013</b>	737065220	0,098
DL/GL 1,3-1,6	82=>	700/930	<b>05.0015</b>	737065250	0,118

<b>SUZUKI</b>					
Santana SJ410		1265	<b>05.0016</b>	15910A80011	0,139
Santana SJ413		1000	<b>05.0017</b>	15910A83010	0,116
Swift	90=>	580	<b>05.0526</b>	1591083300	•
Swift 1,0-1,3	91=>	430/690	<b>05.1150</b>	1591080E00-1591060B2V000 1591060B04000-1591060B210	•
Swift 1,0	97=>	400/660	<b>05.1149</b>	1591060B50	•
Vitara 1,6 all		853/1007	<b>05.0331</b>	1591085C20-1591085C30 1591061A10	0,117
Vitara 1,9 TD	97=>	380/510	<b>05.1151</b>	1591086CF0000-1591086CB0 1591086CB1	•

<b>TALBOT</b>					
Horizon EX-GL-LS (single carb.)		1045/1310	<b>05.711</b>	0017082100-001389730	0,121
Horizon GLS-EX-SX	82=>	1240/1440	<b>05.243</b>	0013897400	0,139
Horizon D	83=>	975/1170	<b>05.803</b>	9750110480	0,160
Horizon (inner cable only)		1300	<b>05.1127</b>	480099H	0,015
Samba (inner cable only)		1620	<b>05.810</b>	7903073101	•
1307 LS-GLS	74=>78	1045/1310	<b>05.711</b>	0017082100-001389730	0,121
1307 S	76=>	1150/1345	<b>05.242</b>	0013896900	0,135
1307 GLS	79=>	1240/1440	<b>05.243</b>	0013897400	0,139
1307 GLS (inner cable only)		1300	<b>05.1127</b>	480099H	0,015
1308	79=>	1240/1440	<b>05.243</b>	0013897400	0,139
1510 LS	77=>	1045/1310	<b>05.711</b>	0017082100-001389730	0,121
1510 GLS	82=>	1195/1400	<b>05.623</b>	0055505000	0,160
1515 LS-GLS	77=>	1045/1310	<b>05.711</b>	0017082100-001389730	0,121
Solara GL (single carb.)	07/82=<	1045/1310	<b>05.711</b>	0017082100-001389730	0,121
Solara LS-GLS	07/82=<	1045/1310	<b>05.711</b>	0017082100-001389730	0,121
Solara GLS-SX	07/81=>	1195/1400	<b>05.623</b>	0055505000	0,160
<b>TALBOT KIT</b>					
Samba	=>83	1365/1645	<b>05.624</b>	163068	0,032
Samba	84=>	1714	<b>05.062</b>	162986	0,024

<b>TOYOTA</b>					
Aygo 1,0 all	05=>	1135/1330	<b>05.1103</b>	1629G4-781800H010	0,244
Yaris 1,0i 16v		1400/1655	<b>05.1143</b>	7818042060-7818052050	•
Yaris 1,0	05=>	1100/1285	<b>05.1144</b>	781800D010	•
Yaris 1,3	05=>	1145/1330	<b>05.1145</b>	781800D040	•

**COMANDI ACCELERATORE A PEDALE - ACCELERATOR CABLES (THROTTLE) - CABLES D'ACCELERATEUR  
VERGASERZUGE - CABLES DE ACELERADOR - CABOS DE ACELERADOR  
LINKI GAZU - LANKA PEDÁLU PLYNU - ТРОСЫ ГАЗА**



OEM REF.



**TOYOTA**

Avensis 2,0i 16v		1500/1755	<b>05.1142</b>	7818005200	•
------------------	--	-----------	----------------	------------	---

**VOLKSWAGEN**

1200 Beetle	58=>65	2640	<b>05.320</b>	111721555C	0,033
1200 Beetle	65=>	2620	<b>05.323</b>	111721555A	0,070
1200 Beetle	67=>	2625	<b>05.238</b>	111721555E	0,043
1200 Beetle	71=>	2640	<b>05.329</b>	111721555J	0,037
1600 TL	65=>	2660	<b>05.369</b>	311721555G-112721555	•
Polo	74=>	300/490	<b>05.383</b>	861721555	0,072
Polo	79=>	350/530	<b>05.718</b>	861721555F	0,083
Polo all	94=>	950/1150	<b>05.0179</b>	6N1721555A	0,158
Polo 1,1-1,3	96=>	960/1190	<b>05.0243</b>	6N1721555L	0,155
Polo D	96=>	815/1020	<b>05.0244</b>	6N1721555H	0,120
Polo 1,4-1,6 all	96=>		<b>05.0301</b>	6N1721555K	0,076
Polo all 1,6	96=>00	565/760	<b>05.496</b>	1H0721555A-1H0721555J	0,110
Derby	74=>	300/490	<b>05.383</b>	861721555	0,072
Derby	79=>	350/530	<b>05.718</b>	861721555F	0,083
Lupo 1,0-1,6	95=>	1331/1602	<b>05.0332</b>	6N1721555P	0,199
Lupo 1,0	99=>	335/608	<b>05.0301</b>	6N1721555K	0,076
New Beetle	98=>	1460/1740	<b>05.0304</b>	1J1721555K-1J1721555Q	0,222
Golf	=>74	815/1010	<b>05.237</b>	171721555G	0,146
Golf 1,1	09/75=>	1035/1185	<b>05.300</b>	171721555F-171721555N	0,147
Golf 1,3-1,5	75=>	660/860	<b>05.385</b>	171721555H-171721555J 171721555P	0,120
Golf 1,3-1,5	76=>	660/860	<b>05.385</b>	532721555C	0,120
Golf GTI	=>76	860/1150	<b>05.387</b>	171721555K	0,146
Golf GTI	77=>	865/1055	<b>05.689</b>	171721555T	0,140
Golf D/Jetta D	77=>	725/920	<b>05.388</b>	171721555L	0,110
Golf GTI	82=>	890/1150	<b>05.890</b>	171721555AB	0,120
Golf GTI	83=>	600/790	<b>05.710</b>	191721555	0,089
Golf (auto trans)	83=>	880/1040	<b>05.498</b>	171723555A-171723555B 171723555C-191723555	0,172
Golf/Jetta 1,6	08/83=>	565/770	<b>05.1129</b>	3A1721555B	•
Golf II 1,1-1,3-1,5	83=>91	865/1055	<b>05.689</b>	171721555T	0,140
Golf/Vento 1,4-1,6	09/91=>	1000/1200	<b>05.495</b>	1H0721555D	0,153
Golf/Vento 1,8-2,0	09/91=>	565/760	<b>05.496</b>	1H0721555A	0,110
Golf/Vento TD	09/91=>	705/890	<b>05.497</b>	1H0721555B	0,106
Golf III/Vento 1,9 D	93=>00	682/940	<b>05.1155</b>	1H0721555Q	•
Golf/Vento 1,4-1,8	11/94=>	1000/1195	<b>05.1131</b>	1H0721555R	•
Golf/Vento 2,0 8v	08/94=>09/97	570/765	<b>05.1130</b>	1H0721555M	0,110
Golf III VR6	=>95	828/1176	<b>05.1153</b>	1H0721555C	•
Golf III VR6	95=>	859/1140	<b>05.1154</b>	1H0721555A	•
Golf/Vento 1,6 16v	07/95=>09/97	570/765	<b>05.1130</b>	1H0721555P	0,110
Golf III/Vento 1,4-1,6	96=>98	430/704	<b>05.1152</b>	1H0721555T	•
Golf 1,4i (55cv)	98=>	1515/1710	<b>05.0528</b>	1J1721555N	0,234

**COMANDI ACCELERATORE A PEDALE - ACCELERATOR CABLES (THROTTLE) - CABLES D'ACCELERATEUR  
VERGASERZUGE - CABLES DE ACELERADOR - CABOS DE ACELERADOR  
LINKI GAZU - LANKA PEDÁLU PLYNU - ТРОСЫ ГАЗА**



<b>VOLKSWAGEN</b>					
Scirocco 1,3-1,5	75=>	660/860	<b>05.385</b>	171721555H-171721555J 171721555P	0,120
Scirocco 1,3-1,5	76=>	660/860	<b>05.385</b>	532721555C	0,120
Scirocco GTI	=>76	860/1150	<b>05.387</b>	171721555K	0,146
Scirocco GTI	77=>	860/1150	<b>05.689</b>	171721555T	0,140
Scirocco GTI	82=>	890/1150	<b>05.890</b>	171721555AB	0,120
Scirocco K Jet	83=>	815/1010	<b>05.891</b>	531721555F	0,147
Passat	76=>	540/940	<b>05.502</b>	321721555E	0,100
Passat	75=>	650/840	<b>05.391</b>	321721555B	0,080
Passat LS-GLS	76=>	645/865	<b>05.273</b>	321721555D	0,097
Passat-Santana 1,6	80=>	655/920	<b>05.765</b>	321721555S	0,111
Passat-Santana 1,8	83=>	665/890	<b>05.716</b>	321721555AA	0,121
Passat 1,6-1,8	88=>	600/790	<b>05.710</b>	191721555	0,089
Passat (auto trans)		645/870	<b>05.777</b>	321723555	0,088
Passat (auto trans)		645/840	<b>05.776</b>	321723555D	0,080
Passat 1,8	93=>	1000/1200	<b>05.0181</b>	3A1721555	0,128
Passat D	75=>	515/740	<b>05.764</b>	321721555F-321721555R	0,087
Passat TD/Santana TD	78=>	515/740	<b>05.764</b>	321721555F-321721555R	0,087
Passat TD/Santana TD	83=>	805/1020	<b>05.849</b>	321721555T	0,121
Passat TD	88=>	725/920	<b>05.388</b>	171721555L	0,110
Passat D-TD	89=>92	705/910	<b>05.0182</b>	357721555A	0,105
Passat TD	93=>	730/935	<b>05.0183</b>	3A1721555A	0,102
Passat 1,8-2,0 (ch. -3A-R-220000)	04/88=>07/94	565/770	<b>05.1129</b>	3A1721555B	•
Passat 1,8-2,0 (ch. 3A-R-220000-)	04/88=>07/94	1000/1195	<b>05.1131</b>	1H0721555R	•
Passat 1,6 16v	10/94=>	570/765	<b>05.1130</b>	1H0721555P-1H0721555M	0,110
Passat (auto trans) AT (ch. -3A-S-050001)	09/94=>09/96	570/765	<b>05.1130</b>	1H0721555P-1H0721555M	0,110
Passat 2,0 8v (ch. 3A-R-185001-)	05/94=>09/96	570/765	<b>05.1130</b>	1H0721555P-1H0721555M	0,110
Sharan 1,8-2,0	97=>	905/1115	<b>05.0529</b>	7M1721555E	0,195
Sharan 2,0i	97=>	565/755	<b>05.1132</b>	7M1721555-7M1721555M	•



<b>VOLKSWAGEN - Commercial Vehicle</b>					
Caddy	77=>	725/920	<b>05.388</b>	171721555L	0,110
Transporter 1,6	=>10/68	3360	<b>05.512</b>	211721555D	•
Transporter 1,6-1,7	=>07/72	3670	<b>05.393</b>	211721555J	0,050
Transporter 1,6 (II°)	72=>	3685	<b>05.395</b>	211721555L-211721555P 211721555R	0,037
Transporter 1,6	74=>	3435	<b>05.397</b>	211721555N	0,042
Transporter 1,7ie	75=>	3470	<b>05.292</b>	211721555S-211721555AA	0,047
Transporter 1,6 (II°)	76=>	3655	<b>05.400</b>	211721555T	0,055
Transporter 1,6-2,0	80=>	3560	<b>05.766</b>	251721555	0,032
Transporter 2,0 (II°)	=>82	3805	<b>05.719</b>	251721555B	0,052
Transporter 2,0	82=>	3975	<b>05.731</b>	251721555G	0,236
Transporter D	80=>	1340/3980	<b>05.739</b>	251721555C	0,260
Transporter D	82=>	1290/1345	<b>05.753</b>	251721555K	0,281
Transporter 2,0	84=>	920/3610	<b>05.149</b>	251721555Q	0,213

**COMANDI ACCELERATORE A PEDALE - ACCELERATOR CABLES (THROTTLE) - CABLES D'ACCELERATEUR  
VERGASERZUGE - CABLES DE ACELERADOR - CABOS DE ACELERADOR  
LINKI GAZU - LANKA PEDÁLU PLYNU - ТРОСЫ ГАЗА**



OEM REF.



**VOLKSWAGEN - Commercial Vehicle**

Transporter 2,0	83=>	3720	<b>05.506</b>	251721555R-251721555P	0,173
Transporter	=>90	1320/3970	<b>05.0335</b>	251721555S	0,245
Transporter 2,0	90=>	875/1125	<b>05.0184</b>	701721555J	0,164
Transporter D 1,9 TDI	90=>	1000/1230	<b>05.0185</b>	701721555K-701721555A	0,206
Transporter D 2,4	90=>	1460/1700	<b>05.0186</b>	701721555L-701721555D	0,211
Transporter	90=>	910/1205	<b>05.0305</b>	701721555H	0,160
Transporter	90=>	660/960	<b>05.0306</b>	701721555G	0,125
LT 31 D (Perkins mot.)	76=>	880	<b>05.266</b>	281721555B	0,020
LT D (6 cyl.)	79=>	860/1270	<b>05.268</b>	281721555K	0,166

**VOLVO**

160 all	73=>75	430/660	<b>05.526</b>	1221662	0,091
240 B21A-19A	76=>79	770/950	<b>05.528</b>	12289510	0,176
240 B21A-19A	79=>85	940/1110	<b>05.529</b>	1227507	0,192
240 B19-21-23E-F	75=>79	670/950	<b>05.532</b>	1229439	0,183
240 B19-21-23E-F	80=>	390/650	<b>05.535</b>	1272897	0,112
260 B27	75=>81	500/700	<b>05.536</b>	12290268	0,135

**ZASTAVA**

Yugo 45		310/445	<b>05.801</b>	4427794	0,101
Yugo Florida-Miami	89=>	455/600	<b>05.126</b>	46622749	•
101		930/1140	<b>05.446</b>	-	0,308







**automotive products**







**COMANDI FLESSIBILI FUNE FRENO  
A MANO  
BRAKE CABLES  
CABLES DE FREIN  
BREMSSEILE  
CABLES DE FRENO  
CABOS DE TRAVAO  
LINKI HAMULCA  
BRZDOVÁ LANKA  
ТРОСЫ РУЧНОГО ТОРМОЗА**

ALFA ROMEO .....	pag. 70-71
ARO .....	pag. 71
AUDI .....	pag. 72-74
BMW .....	pag. 74-75
CHEVROLET-DAEWOO .....	pag. 75-76
CHRYSLER .....	pag. 76
CITROEN .....	pag. 76-80
DAIHATSU .....	pag. 80
FERRARI .....	pag. 80
FIAT .....	pag. 81-89
FORD .....	pag. 89-94
HONDA .....	pag. 94-96
HYUNDAI .....	pag. 96-97
INNOCENTI .....	pag. 97
ISUZU .....	pag. 97
KIA .....	pag. 97-98
LADA .....	pag. 98
LANCIA .....	pag. 98-100
MAZDA .....	pag. 100-102
M.C.C. ....	pag. 102
MERCEDES .....	pag. 102-105
MITSUBISHI .....	pag. 106
NISSAN .....	pag. 107-111
OPEL .....	pag. 111-116
PEUGEOT .....	pag. 116-121
POLSKI .....	pag. 121
PORSCHE .....	pag. 121
RENAULT.....	pag. 121-127
ROVER .....	pag. 127-129
SAAB .....	pag. 129
SEAT .....	pag. 130-131
SKODA .....	pag. 131-132
SUBARU .....	pag. 132
SUZUKI .....	pag. 132-133
TALBOT .....	pag. 133-134
TOYOTA .....	pag. 134-139
VAUXHALL .....	pag. 139-140
VOLKSWAGEN.....	pag. 140-144
VOLVO.....	pag. 144-146
ZASTAVA.....	pag. 146





**COMANDI FLESSIBILI FUNE FRENO A MANO - BRAKE CABLES - CABLES DE FREIN  
BREMSSEILE - CABLES DE FRENO - CABOS DE TRAVAO  
LINKI HAMULCA - BRZDOVÁ LANKA - ТРОСЫ РУЧНОГО ТОРМОЗА**

				OEM REF.	
<b>ALFA ROMEO</b>					
Alfasud all	72=>	1255/1390	<b>07.249</b>	530728-60745071	0,423
Alfasud Sprint all	83=>88	1485/1715	<b>07.916</b>	543079-60505003	0,625
Sprint all	83=>	1485/1715	<b>07.916</b>	543079-60505003	0,625
Arna all (LH-SX)	83=>	730/1100	<b>07.0054</b>	543611	0,318
Arna all (RH-DX)	83=>	675/900	<b>07.0055</b>	543610	0,287
33 all (LH/RH-SX/DX)	83=>89	1480/1690	<b>07.007</b>	60501672-60501673	0,612
33 all antiskid-4x4 (RH-DX)	90=>94	1625/1785	<b>07.057</b>	60548444-60580073	0,532
33 all antiskid-4x4 (LH-SX)	90=>94	1500/1660	<b>07.056</b>	60548443-60580074	0,509
33 Permanent 4 (drum brake) (LH/RH-SX/DX)	90=>94	1385/1615	<b>07.326</b>	60580076	0,583
33 Elegant-Sport (4x2) (RH-DX)	90=>91	1385/1615	<b>07.326</b>	60580076	0,583
33 Wagon-Elegant-Sport (4x2) (LH-SX)	90=>94	1383/1590	<b>07.325</b>	60580075	0,490
33 Wagon-Elegant-Sport (4x2) (RH-DX)	92=>94	1510/1715	<b>07.0527</b>	60580072-60559851	0,600
33 1,5ie (LH/RH-SX/DX)	89=>	1380/1615	<b>07.1921</b>	60500501	0,568
145/146 all (front-avt)	92=>	405	<b>07.149</b>	60806293-60811362-46410282	0,112
145/146 all 1,3-1,6 (LH-SX)	95=>	1055/1460	<b>07.0004</b>	7773015-60813764	0,458
145/146 all 1,3-1,6 (RH-DX)	95=>	1015/1420	<b>07.0005</b>	7773019	0,443
145/146 1,7 16v (LH-SX)	92=>	1155/1517	<b>07.0427</b>	60806307-7714822-60812546	0,505
145/146 1,7 16v (RH-DX)	92=>	1120/1460	<b>07.329</b>	60577826-60806310-60812799	0,494
147 all (front-avt)	01=>	405	<b>07.149</b>	60806293-60811362-46410282	0,112
147 all (RH-DX)	01=>	895/1170	<b>07.0803</b>	46542755	0,497
147 all (LH-SX)	01=>	961/1235	<b>07.0804</b>	46542828	0,486
Giulia 1,3-1,6 all	69=>	2190/2570	<b>07.229</b>	105394203000	0,978
Giulia all	70=>	1125/1670	<b>07.243</b>	105264203001-60712612	0,836
Giulia 1750-2000 (LH-SX)		570	<b>07.782</b>	105484206100-60515933	0,055
Giulia 1750-2000 (RH-DX)		540	<b>07.783</b>	105484206200-60515940	0,155
1750/2000 (with tank)	68=>	1240/1720	<b>07.594</b>	105484203003	0,786
1750/2000 GTV (with tank)	68=>	1030/1550	<b>07.230</b>	105304203003	0,748
1750/2000 Spyder (with tank)	68=>	980/1490	<b>07.658</b>	105574203003-60517076	0,772
Giulietta all	77=>	1350/1630	<b>07.584</b>	116334203000-60521838	0,490
Giulietta (191) all (LH-SX)	10=>	1625/1795	<b>07.1937</b>	50502989	0,557
Giulietta (191) all (RH-DX)	10=>	1860/1960	<b>07.1938</b>	50502987	0,587
Alfetta all	80=>	1350/1630	<b>07.584</b>	116334203000-60521838	0,490
Alfetta 1,6-1,8	=>79	1260/1535	<b>07.248</b>	116004203001	0,436
75 all	85=>	1350/1630	<b>07.584</b>	60521838	0,490
90 all	85=>	1350/1630	<b>07.584</b>	60521838	0,490
155 all (front-avt)	92=>	405	<b>07.149</b>	60806293-60811362-46410282	0,112
155 all (RH-DX)	92=>	1110/1460	<b>07.329</b>	60577826-60806310-60812799	0,494
155 all (exc.2,5 V6) (LH-SX)	92=>	1155/1517	<b>07.0427</b>	60806307-7714822-60812546	0,505
155 V6 2,5 (LH-SX)	92=>	1150/1500	<b>07.0109</b>	60806311	0,465





**COMANDI FLESSIBILI FUNE FRENO A MANO - BRAKE CABLES - CABLES DE FREIN  
BREMSSEILE - CABLES DE FRENO - CABOS DE TRAVAO  
LINKI HAMULCA - BRZDOVÁ LANKA - ТРОСЫ РУЧНОГО ТОРМОЗА**

				OEM REF.	
<b>ALFA ROMEO</b>					
155 TB 2,0 (LH-SX)		787/2428	<b>07.435</b>	60807561-82464806	0,423
155 TB 2,0 (RH-DX)		800/1190	<b>07.434</b>	60807562-82464807	0,435
156 all (front-avt)	97=>	405	<b>07.149</b>	60806293-60811362-46410282	0,112
156 all (RH-DX)	97=>	920/1196	<b>07.0109/1</b>	60624590	0,414
156 all (LH-SX)	97=>	985/1256	<b>07.043/1</b>	60624591	0,420
159 all (RH-DX)	05=>	1585/1735	<b>07.1674</b>	50500557-50505370	0,704
159 all (LH-SX)	05=>	1603/1755	<b>07.1675</b>	50500558-50505371	0,700
MiTo all (RH-DX)	08/08=>	1440/1673	<b>07.1354</b>	55704103	0,545
MiTo all (LH-SX)	08/08=>	1422/1654	<b>07.1355</b>	55704104	0,559
MiTo all (LH-SX)	11/09=>	1422/1641	<b>07.1890</b>	50519022-51871599-51844531	•
MiTo all (RH-DX)	11/09=>	1440/1658	<b>07.1891</b>	50519020-51871598	•
164 all (front-avt)	87=>	262	<b>07.131</b>	82399827	0,049
164 all	87=>	1260+1400/ 2970	<b>07.132</b>	82390671-60801383-60801790 82441688	1,025
164 all (with prot.)	92=>	1260+1400/ 2970	<b>07.097</b>	82481842-60808316	1,162
166 all (front-avt)	98=>	311	<b>07.0239</b>	60813842-82488247	0,119
166 all (RH-DX)	98=>	1303/1427	<b>07.1033</b>	60661490-60630814	0,628
166 all (LH-SX)	98=>	1320/1445	<b>07.1034</b>	60661488-60630812	0,584
Brera all (RH-DX)	04/06=>	1445/1577	<b>07.1756</b>	50505484	•
Brera all (LH-SX)	04/06=>	1662/1529	<b>07.1757</b>	50505483	•
GTV 6 Coupé (LH/RH-SX/DX)	81=>	1090/1370	<b>07.048</b>	116464060010	0,425
GTV Coupé (LH/RH-SX/DX)	95=>	1240/1580	<b>07.0258/1</b>	60616741-60626919	0,563
Spyder 2,0-1750-2000	91=>94	980/1490	<b>07.658</b>	105574203003-60517076	0,772
Spyder 2,0 (interm.) (LH-SX)	91=>94	570	<b>07.782</b>	105484206101-60515933	0,055
Spyder 2,0 (interm.) (RH-DX)	91=>94	540	<b>07.783</b>	105484206201-60515940	0,155
Spyder 2,0 (LH/RH-SX/DX)	95=>	1240/1580	<b>07.0258/1</b>	60616741-60626919	0,563
					
<b>ALFA ROMEO - Commercial Vehicle</b>					
AR 8 all (front-avt) "A"	=>85	1050/1240	<b>07.654</b>	93801422	•
AR 8 all (front-avt) "B"	=>85	1450/1640	<b>07.655</b>	93801912	1,202
AR 8 all (front-avt) "C"	=>85	1840/2040	<b>07.656</b>	93801943	1,465
AR 8 all	=>89	955+955/ 2395	<b>07.657</b>	93801482	0,730
<b>ARO</b>					
10.1/Ischia		950+950/ 2420	<b>07.334</b>		0,960
Dacia		765+765/ 2300	<b>07.337</b>	1100006724	0,635





**COMANDI FLESSIBILI FUNE FRENO A MANO - BRAKE CABLES - CABLES DE FREIN  
BREMSSEILE - CABLES DE FRENO - CABOS DE TRAVAO  
LINKI HAMULCA - BRZDOVÁ LANKA - ТРОСЫ РУЧНОГО ТОРМОЗА**

				OEM REF.	
<b>AUDI</b>					
50 all (front-avt)	74=>	795	<b>07.587</b>	861609729	•
50 all	74=>	630+370/ 1945	<b>07.732</b>	861609721	0,422
50 all	75=>	365+610/ 1990	<b>07.588</b>	861609721A-861609721B	0,401
A1 all (disc brake) (LH/RH-SX/DX)	05/10=>	1045/1640	<b>07.1812</b>	6R0609721C	0,381
A2 all (LH/RH-SX/DX)	00=>03	814/1075	<b>07.1321</b>	8Z0609721B	0,361
A2 all (drum brake) (RH-DX)	03=>	814/1075	<b>07.1321</b>	8Z0609722G-8Z0609722C	0,361
A2 all (drum brake) (-ch. 8Z3010000) (LH-SX)	03=>	814/1075	<b>07.1321</b>	8Z0609721F	0,361
A2 all (disc brake) (RH-DX)	03=>	940/1147	<b>07.1322</b>	8Z0609722D	0,365
A2 all (disc brake) (-ch. 8Z4100000) (LH-SX)	03=>	940/1147	<b>07.1322</b>	8Z0609721A	0,365
A2 all (disc brake) (ch. 8Z4100001-) (LH-SX)	03=>	923/1130	<b>07.1323</b>	8Z0609721D	•
A2 all (disc brake) (LH-SX)	03=>	910/1120	<b>07.1324</b>	8Z0609721E	•
A2 all (drum brake) (ch. 8Z3010001-) (LH-SX)	03=>	795/1057	<b>07.1325</b>	8Z0609721G-8Z0609721C	•
A3 all (LH/RH-SX/DX)	96=>	820/1055	<b>07.0410</b>	1J0609721E	0,392
A3 all (LH/RH-SX/DX)	97=>	1070/1700	<b>07.0991</b>	1J0609721AC-1J0609721AD 1J0609721K-1J0609721	0,372
A3 Quattro (LH/RH-SX/DX)	98=>	1090/1273	<b>07.0806</b>	1J0609721L-1J0609721R	0,459
A3 (LH/RH-SX/DX)	03=>	810/1450	<b>07.1441</b>	1K0609721Q	0,366
A3 all (RH-DX)	10/03=>	805/1443	<b>07.1442</b>	1K0609721T-1K0609721AA 1K0609721S	0,388
A3 Cabrio all (LH/RH-SX/DX)	08=>	790/1428	<b>07.1758</b>	1K0609721BF-1K0609721BG	•
A4 all (LH/RH-SX/DX)	95=>	1640/1815	<b>07.0411</b>	8D0609721H	0,736
A4 all (RH-DX)	00=>	1845/2012	<b>07.1086</b>	8E0609722L-8E0609722AF	0,751
A4 all (LH-RX)	00=>	1770/1927	<b>07.1087</b>	8E0609721L-8E0609721AF	0,696
A4 Quattro (LH/RH-SX/DX)	00=>03	1555/1722	<b>07.1088</b>	8E0609721AD	0,585
A4 S4 all (LH/RH-SX/DX)	=>01	1600/1770	<b>07.1326</b>	8E0609721AC	0,595
A4 Quattro all (LH/RH-SX/DX)	03=>06	1572/1736	<b>07.1565</b>	8E0609721AJ	0,608
80 all	73=>74	600+600/ 2225	<b>07.591</b>	823609721A	0,500
80 all	08/74=>	470+480/ 2230	<b>07.465</b>	321609721	0,760
80 all	76=>	460+460/ 2252	<b>07.489</b>	321609721A	0,428
80 all	78=>	435+435/ 2370	<b>07.823</b>	811609721	0,411
80 all (with shock absorb.)	08/78=>	445+445/ 2400	<b>07.913</b>	811609721A	0,605
80/90 (drum brake) (LH-SX)	10/85=>	435/1200	<b>07.108</b>	811609721B-811609721H 811609721J-811609721C	0,223
80/90 (drum brake) (RH-DX)	10/85=>	435/1155	<b>07.106</b>	811609722A-811609722D 811609722E-811609722B	0,222
80/90 Coupé (drum brake) (LH-SX)	87=>	1110/1360	<b>07.099</b>	893609721A-893609721G	0,426
80/90 Coupé (drum brake) (RH-DX)	87=>	1070/1310	<b>07.098</b>	893609722A-893609722G	0,413
80/90 all (disc brake) (LH-SX)	87=>91	1175/1375	<b>07.060</b>	811609721G	0,243
80/90 all (disc brake) (RH-DX)	87=>91	545/1220	<b>07.061</b>	811609722C	0,240
80/90 Coupé (disc brake) (LH-SX)	88=>	1214/1415	<b>07.339</b>	893609721F	0,484
80/90 Coupé (disc brake) (RH-DX)	88=>	1175/1375	<b>07.340</b>	893609722F	0,474
80/90 (disc brake) (LH/RH-SX/DX)	09/91=>	1590/1750	<b>07.0350</b>	8A0609721AF-8A0609721J 8A0609721T	0,700
80/90 (drum brake) (LH/RH-SX/DX)	09/91=>	1390/1600	<b>07.0351</b>	8A0609721AE-8A0609721H 8A0609721S	0,576

**COMANDI FLESSIBILI FUNE FRENO A MANO - BRAKE CABLES - CABLES DE FREIN  
BREMSEILE - CABLES DE FRENO - CABOS DE TRAVAO  
LINKI HAMULCA - BRZDOVÁ LANKA - ТРОСЫ РУЧНОГО ТОРМОЗА**





				OEM REF.	
<b>AUDI</b>					
80 Quattro Coupé (RH-DX)		1095/1305	<b>07.1485</b>	893609722E	•
80 Quattro Coupé (LH-SX)		1125/1340	<b>07.1486</b>	893609721E	0,494
80/90 F8C-P-235 316 (RH-DX)	92=>	1565/1723	<b>07.1488</b>	8A0609702A	•
80/90 F8C-P-235 316 (LH-SX)	92=>	1565/1723	<b>07.1489</b>	8A0609701A	•
100 all (ch. 41000116-)	=>08/74	755+755/ 2285	<b>07.582</b>	803609721C	0,569
100 all (ch. 51000051-)	74=>76	710+710/ 2340	<b>07.583</b>	803609721D	0,596
100 all	09/76=>	1105+1105/ 2890	<b>07.914</b>	431609721D	0,775
100 all (LH/RH-SX/DX)	83=>	820/1410	<b>07.915</b>	443609721-443609721K	0,410
100 all (disc brake) (LH/RH-SX/DX)	83=>	910/1445	<b>07.118</b>	443609721A	0,330
100 all (disc brake) (LH/RH-SX/DX)	85=>	890/1455	<b>07.589</b>	443609721G-443609721E	0,349
100 Quattro (disc brake) (LH/RH-SX/DX)	85=>88	1550/1750	<b>07.342</b>	443609721C	0,600
100 all (drum brake) (LH/RH-SX/DX)	92=>	820/1420	<b>07.734</b>	4A0609721B	0,389
100 all (disc brake) (LH/RH-SX/DX)	92=>	920/1490	<b>07.737</b>	4A0609721C	0,403
100 Quattro (RH-DX)	94=>	1503/1676	<b>07.0808</b>	441609722D	0,610
100 Quattro (LH-SX)	94=>	1520/1697	<b>07.0807</b>	441609721D	0,630
200 (disc brake) (LH-SX)	=>82	1170/1580	<b>07.994</b>	437609721	0,445
200 (disc brake) (RH-DX)	=>82	1220/1410	<b>07.998</b>	437609722	0,440
200 (disc brake) (LH-SX)	82=>	1200/1480	<b>07.139</b>	437609721A	0,482
200 (disc brake) (RH-DX)	82=>	1220/1485	<b>07.141</b>	437609722A	0,461
200 all (disc brake) (LH/RH-SX/DX)	88=>	890/1455	<b>07.589</b>	443609721G-443609721E	0,349
200 Quattro (LH/RH-SX/DX)	85=>88	1540/1700	<b>07.344</b>	443609722	0,592
200 Quattro (RH-DX)	94=>	1503/1676	<b>07.0808</b>	441609722D	0,610
200 Quattro (LH-SX)	94=>	1520/1697	<b>07.0807</b>	441609721D	0,630
A6 all (LH/RH-SX/DX)	95=>	365+925/ 1495	<b>07.0412</b>	4A0609721D	0,430
A6 Quattro (RH-DX)	97=>	1503/1676	<b>07.0808</b>	441609722D	0,610
A6 Quattro (LH-SX)	97=>	1520/1697	<b>07.0807</b>	441609721D	0,630
A6 all (RH-DX)	98=>	1705/1958	<b>07.1089</b>	4B0609722L	1,061
A6 all (LH-SX)	98=>	1705/1958	<b>07.1090</b>	4B0609721M	1,072
A6 (USA mod. ) (LH/RH-SX/DX)	95=>	920/1490	<b>07.737</b>	4A0609721F	0,403
A6-A6 Allroad-A6 Avant (LH/RH-SX/DX)	01=>	1755/1920	<b>07.1327</b>	4B0609721AD-4B0609721N 4B0609721S	0,770
S6 (LH-SX)	97=>	1520/1697	<b>07.0807</b>	441609721D	0,630
S6 (RH-DX)	97=>	1503/1676	<b>07.0808</b>	441609722D	0,610
S8 (RH-DX)	94=>03	1560/1720	<b>07.1091</b>	4D0609722K-4D0609722H	0,674
S8 (LH-SX)	94=>03	1495/1657	<b>07.1092</b>	4D0609721K-4D0609721H	0,652
A8 2,8 (-ch. 4DT003660) (RH-DX)	06/94=>96	1545/1701	<b>07.0809</b>	4D0609722J-4D0609722G	0,618
A8 2,8 (-ch. 4DT003660) (LH-SX)	06/94=>96	1500/1657	<b>07.0810</b>	4D0609721J-4D0609721G	0,689
A8 Quattro (RH-DX)	97=>	1560/1720	<b>07.1091</b>	4D0609722K-4D0609722H	0,674
A8 Quattro (LH-SX)	97=>	1495/1657	<b>07.1092</b>	4D0609721K-4D0609721H	0,652
A8 all (RH-DX)	99=>03	1690/1850	<b>07.2022</b>	4D0609722N	•
A8 all (LH-SX)	99=>03	1615/1775	<b>07.2023</b>	4D0609721N	•
TT all (exc.Quattro) (LH/RH-SX/DX)	00=>	1055/1610	<b>07.1093</b>	8N0609721F	•

**COMANDI FLESSIBILI FUNE FRENO A MANO - BRAKE CABLES - CABLES DE FREIN  
BREMSEILE - CABLES DE FRENO - CABOS DE TRAVAO  
LINKI HAMULCA - BRZDOVÁ LANKA - ТРОСЫ РУЧНОГО ТОРМОЗА**

				OEM REF.	
<b>AUDI</b>					
TT Quattro (LH/RH-SX/DX)	00=>	1105/1660	<b>07.1094</b>	8N0609721G-8N0609721E 8N0609721H	•
TT all (LH/RH-SX/DX)	=>00	1055/1610	<b>07.1487</b>	8N0609721C	0,402
TT all (LH-SX)	06=>	782/1417	<b>07.1939</b>	8J0609721E	0,302
TT all (RH-DX)	06=>	770/1385	<b>07.1940</b>	8J0609722E	0,302
Cabrio all (disc brake) (LH/RH-SX/DX)	92=>08/00	1200/1425	<b>07.1759</b>	895609721A	•
Coupé all (LH/RH-SX/DX)	88=>12/96	1200/1425	<b>07.1759</b>	895609721A	•
Q7 (front-avt)	06=>	1685/1890	<b>07.1760</b>	7L0721556B	•
Q7 all (LH/RH-SX/DX)	06=>	1805/1910	<b>07.1854</b>	7L8609721C	•

<b>BMW</b>					
1500/1600/1800/2000 (LH/RH-SX/DX)	65=>71	840/1710	<b>07.358</b>	34411103130	0,331
1602/1802/2002 (LH/RH-SX/DX)	66=>75	535/1530	<b>07.359</b>	34411103128	0,242
316/318/320 (LH/RH-SX/DX)	75=>	660/1640	<b>07.593</b>	34411114215	0,288
316/318/320/324TD (LH/RH-SX/DX)	83=>	775/1840	<b>07.142</b>	34411154401-34411154681	0,308
323 (LH/RH-SX/DX)	75=>	710/1620	<b>07.680</b>	34411120189	0,338
323 ABS/318/320/324TD (LH/RH-SX/DX)	83=>	665/1725	<b>07.361</b>	34411153582	0,364
316/320 (disc brake) (LH/RH-SX/DX)	90=>	1085/1645	<b>07.0400</b>	34411160134	0,388
325i (4 doors) (LH/RH-SX/DX)	92=>	1085/1645	<b>07.0400</b>	34411160134	0,388
316/320 (drum brake) (LH/RH-SX/DX)	90=>	1190/1760	<b>07.0401</b>	34411159048	0,400
316/318TD Compact (LH/RH-SX/DX)	93=>	1070/1740	<b>07.0413</b>	34411160873	0,415
318 Ti Compact (LH/RH-SX/DX)	93=>	1090/1685	<b>07.0414</b>	34411160874	0,383
318 Compact all (E36) (LH/RH-SX/DX)	98=>00	1090/1680	<b>07.1331</b>	34401166053	0,438
518/518i/520/520i (LH/RH-SX/DX)	73=>	865/1700	<b>07.362</b>	34411107962	0,337
518/520i/524TD (LH/RH-SX/DX)	81=>	840/1865	<b>07.918</b>	34411150896	0,352
518/520i (LH/RH-SX/DX)	80=>	710/1705	<b>07.919</b>	34411156356-34411150784	0,272
518/520i (LH/RH-SX/DX)	82=>86	690/1685	<b>07.143</b>	34411154106	0,266
518 (E34) (drum brake) (LH/RH-SX/DX)	09/88=>	750/1880	<b>07.0309</b>	34401154437	0,330
518/520 (disc brake) (LH/RH-SX/DX)	09/88=>	620/1755	<b>07.0402</b>	34411156436-34411162005	0,347
524TD/525/528 (LH/RH-SX/DX)	82=>	710/1705	<b>07.919</b>	34411156356-34411150784	0,272
525/528 (LH/RH-SX/DX)	75=>	960/1730	<b>07.679</b>	34411118579	0,417
528i (LH/RH-SX/DX)	82=>	690/1685	<b>07.143</b>	34411152685-34411152689	0,266
Serie 1 all (LH/RH-SX/DX)	03=>	755/1434	<b>07.1329</b>	34406760443	0,343
Serie 1 (F20) Berlina 1,6-2,0 all (LH/RH-SX/DX)	11=>	775/1460	<b>07.1661</b>	34406792263-34406851830 34406857639	•
Serie 3 all (RH-DX)	97=>	1140/1703	<b>07.0812</b>	34411165020	0,413
Serie 3 all (LH-SX)	97=>	1140/1693	<b>07.0813</b>	34411165021	0,430
Serie 3 all (E90-91) (LH/RH-SX/DX)	05=>	755/1533	<b>07.1330</b>	34406760444	0,340
Serie 3 all (F30/31)Berlina/Touring all(LH/RH-SX/DX)	11=>	790/1585	<b>07.1662</b>	34406792268-34406857640	•
Serie 5 all (LH-SX)	96=>	1170/1930	<b>07.0415</b>	34411162998	0,438
Serie 5 all (RH-DX)	96=>	1120/1890	<b>07.0416</b>	34411162999	0,409
Serie 5 all (RH-DX)	95=>	1170/1925	<b>07.1490</b>	34401166234	0,497

**COMANDI FLESSIBILI FUNE FRENO A MANO - BRAKE CABLES - CABLES DE FREIN  
BREMSSEILE - CABLES DE FRENO - CABOS DE TRAVAO  
LINKI HAMULCA - BRZDOVÁ LANKA - ТРОСЫ РУЧНОГО ТОРМОЗА**

				OEM REF.	
<b>BMW</b>					
Serie 5 all (LH-SX)	95=>	1120/1875	<b>07.1491</b>	34401166237	0,488
Serie 5 all (LH/RH-SX/DX)	03=>	1170/1680	<b>07.1332</b>	34406761097-34406761098	0,463
Serie 7 Berlina (E38) ABS+ASC+T (RH-DX)	88=>	570/1120	<b>07.0418</b>	35511161474	0,239
728/733/735/745 (LH/RH-SX/DX)	81=>	685/1820	<b>07.978</b>	34411150990	0,373
728/733/735/745 ABS (LH/RH-SX/DX)	82=>	690/1685	<b>07.143</b>	34411152689-34411152685	0,266
728/733/745 (LH/RH-SX/DX)	78=>	885/1805	<b>07.843</b>	34411118581-34411120725 34411121864	0,543
728/733/735 (LH/RH-SX/DX)	82=>86	625/1790	<b>07.0417</b>	34411152690	0,358
730i/735i/750i (LH/RH-SX/DX)	86=>94	635/1855	<b>07.062</b>	34411154244	0,366
730 E38 3,0 ABS+ASC+T (RH-DX)	88=>	570/1120	<b>07.0418</b>	35511161474	0,239
730 F38 3,0 (LH-SX)	07/94=>	997/1265	<b>07.0814</b>	35511161473	0,481
735i/750i (LH/RH-SX/DX)	86=>94	635/1965	<b>07.063</b>	34411156326	0,370
2500/2800/3000 (LH/RH-SX/DX)	70=>	960/1760	<b>07.683</b>	34411118577	0,353
2500/3000 Coupé (LH/RH-SX/DX)	70=>	860/1600	<b>07.682</b>	34411118578	0,387
3000 (LH/RH-SX/DX)	75=>	865/1860	<b>07.681</b>	34411118580	•
Z3 all 4 cyl. (LH/RH-SX/DX)	97=>	910/1255	<b>07.0815</b>	34411163084-34401166054	0,358
Z3 all 6 cyl. (LH/RH-SX/DX)	97=>	942/1283	<b>07.0816</b>	34411163276-34401166055	0,350
Z 4 all (LH/RH-SX/DX)	03=>	883/1090	<b>07.1334</b>	34416757547	0,336
X1 (E84) all (LH/RH-SX/DX)	09=>	1560/1770	<b>07.1941</b>	34406769367	0,351
X3 all (RH-DX)	03=>	1230/1634	<b>07.1335</b>	34403400796	0,450
X3 all (LH-SX)	03=>	1230/1613	<b>07.1336</b>	34403400795	0,447
X5 3,0i (LH/RH-SX/DX)	09/99=>	1161/1942	<b>07.1036</b>	34411165699	0,460
X5 4,4i (LH/RH-SX/DX)	09/99=>	1161/1930	<b>07.1035</b>	34416751843	0,460
<b>BMW MINI</b>					
Mini all (RH-DX)	00=>	1300/1444	<b>07.1193</b>	34411514214	0,514
Mini all (LH-SX)	00=>	1300/1444	<b>07.1194</b>	34411514215	0,521
Mini (R50-R53)-Mini Cabrio (R52) (RH-DX)	03/07=>	1294/1435	<b>07.1761</b>	34406777399	0,553
Mini (R50-R53)-Mini Cabrio (R52) (LH-SX)	03/07=>	1290/1433	<b>07.1762</b>	34406777400	0,548
Mini (R55) all Clubman (RH-DX)	11/07=>	1235/1495	<b>07.1763</b>	34406770868	•
Mini (R55) all Clubman (LH-SX)	11/07=>	1225/1485	<b>07.1764</b>	34406770869	•
Mini (R56)-Mini Cabrio (R57) (RH-DX)	03/07=>	1155/1415	<b>07.1765</b>	34406769954	•
Mini (R56)-Mini Cabrio (R57) (LH-SX)	03/07=>	1140/1405	<b>07.1766</b>	34406769955	•
<b>CHEVROLET-DAEWOO</b>					
Tico all	95=>	1365+1310/ 3065	<b>07.0577</b>		1,155
Matiz all	98=>	1216+1216/ 2825	<b>07.0831</b>	96316682-96518596	1,068
Matiz (II) 800/1000cc	05=>02/10	1585+1585/ 3013	<b>07.1943</b>	96666925	1,248

**COMANDI FLESSIBILI FUNE FRENO A MANO - BRAKE CABLES - CABLES DE FREIN  
BREMSSEILE - CABLES DE FRENO - CABOS DE TRAVAO  
LINKI HAMULCA - BRZDOVÁ LANKA - ТРОСЫ РУЧНОГО ТОРМОЗА**





				<b>OEM REF.</b>	
---	---	---	--	-----------------	---

<b>CHEVROLET-DAEWOO</b>					
Spark all 800/1000cc	05=>02/10	1585+1585/ 3013	<b>07.1943</b>	96666925	1,248
Lanos (RH-DX)	99=>	1350/1585	<b>07.0832</b>	96245829	0,612
Lanos (LH-SX)	99=>	1410/1650	<b>07.1111</b>	96230545	0,554
Leganza all (RH-DX)	97=>	1535/1745	<b>07.1775</b>	96246681-96336081	•
Leganza all (LH-SX)	97=>	1535/1745	<b>07.1776</b>	96246680-96336080	•
Aveo all (LH-SX)	03/06=>	1200/1396	<b>07.1834</b>	96534871	0,555
Aveo all (RH-DX)	03/06=>	1188/1383	<b>07.1835</b>	96534870	0,528
Kalos all (LH-SX)	03/06=>	1200/1396	<b>07.1834</b>	96534871	0,555
Kalos all (RH-DX)	03/06=>	1188/1383	<b>07.1835</b>	96534870	0,528
Nubira 1,6 (drum brake) (LH-SX)	97=>	1455/1650	<b>07.1679</b>	96243462	0,678
Nubira 1,6 (drum brake) (RH-DX)	97=>	1435/1635	<b>07.1680</b>	96243463	0,669
Nubira 2,0 (disc brake) (LH-SX)	97=>	1440/1595	<b>07.1681</b>	96392000	0,691
Nubira 2,0 (disc brake) (RH-DX)	97=>	1420/1570	<b>07.1682</b>	96392001	0,679
Tacuma (LH/RH-SX/DX)	00=>	1277/1544+ 1291/1556	<b>07.1683</b>	96280245	1,408





<b>CHRYSLER</b>					
300C all (LH/RH-SX/DX)	08/04=>	567/711	<b>07.1663</b>	4779592AA	•
Voyager/Gran Voyager 2,5 CRD (disc brake)(LH-SX)	01=>07	840/1690	<b>07.1664</b>	4721027AG-4721027AJ 4721027AK-47210A27L	•
Voyager/Gran Voyager 2,5 CRD (disc brake)(RH-DX)	01=>07	685/1300	<b>07.1665</b>	4721026AF-4721026AG 4721026AH-4721026AK	•
Voyager/Grand Voyager II-III all (front-avt)	95=>08	1380/1515	<b>07.2035</b>	4683285-4683285AC-4683285AD	•
Jeep Cherokee (LH/RH-SX/DX)	87=>	1190/1500	<b>07.879</b>	3952001153	0,369
Jeep CJ3B (Perkins) (front-avt)		738/987	<b>07.0820</b>	75032	0,280
Jeep CJ3B (Perkins)		640+640/ 2426	<b>07.0821</b>	75027	0,600
Neon 2,0 16v (drum brake) (LH/RH-SX/DX)	95=>	1505/1700	<b>07.0817</b>	5273636	0,620
Neon 2,0 16v (disc brake) (LH/RH-SX/DX)	95=>	1502/1713	<b>07.0818</b>	4509633	0,618

<b>CITROEN</b>					
2 CV/Dyane/Mehari	66=>	180/430	<b>07.540</b>	AZ4541F-AZ4541D	0,082
2 CV/Dyane/Mehari (LH-SX)	77=>	590/735	<b>07.920</b>	75491847	0,150
2 CV/Dyane/Mehari (RH-DX)	77=>	410/555	<b>07.685</b>	75491848-75491850	0,253
2 CV/Dyane/Mehari (LH-SX)	81=>	530/675	<b>07.883</b>	75492021	0,138
LN/LNA all (LH/RH-SX/DX)	=>82	700/1255	<b>07.921</b>	7910015915-7910015917	0,290
LN/LNA all (LH/RH-SX/DX)	82=>	720/1270	<b>07.922</b>	95495614	0,283
AX all (LH/RH-SX/DX)	86=>	1195/1415	<b>07.144</b>	95604194	0,364
AX 4x4 (LH/RH-SX/DX)	93=>	1115/1420	<b>07.0135</b>	96044362	0,389
Axel all (LH/RH-SX/DX)	85=>	990/1210	<b>07.145</b>	95493395	0,244

**COMANDI FLESSIBILI FUNE FRENO A MANO - BRAKE CABLES - CABLES DE FREIN  
BREMSSEILE - CABLES DE FRENO - CABOS DE TRAVAO  
LINKI HAMULCA - BRZDOVÁ LANKA - ТРОСЫ РУЧНОГО ТОРМОЗА**

				OEM REF.	
<b>CITROEN</b>					
Visa all (LH/RH-SX/DX)	79=>	810/1450	<b>07.766</b>	7910033436-95493550	0,314
Saxo all (drum brake) (LH/RH-SX/DX)	96=>	1125/1445	<b>07.0112</b>	96209110-4745H7-4745J1	0,344
Saxo all (disc brake) (LH/RH-SX/DX)	96=>	1235/1505	<b>07.0113</b>	96263856-4745H8	0,421
C1 all (LH-SX)	05=>	1243/1486	<b>07.1338</b>	4745Y3	0,536
C1 all (RH-DX)	05=>	1235/1478	<b>07.1454</b>	4745Y2	0,544
C2 all (drum brake) (LH/RH-SX/DX)	03=>	800/1610	<b>07.1095</b>	4750W3-474615-9648084880 9680318880	0,346
C2 all (disc brake) (LH/RH-SX/DX)	03=>	935/1700	<b>07.1096</b>	4750W4-474616-9639346180 9680313780	0,455
C3-C3 Pluriel all (drum brake) (LH/RH-SX/DX)	02=>	867/1715	<b>07.0823</b>	4745V0-9643240880	0,340
C3-C3 Pluriel all (disc brake) (LH/RH-SX/DX)	02=>	1003/1812	<b>07.0824</b>	4745V1	0,499
C3-C3 Pluriel (disc brake) (LH/RH-SX/DX) (ch. 10577-)	02=>	1004/1788	<b>07.1496</b>	474614-9680318480	0,501
C3-C3 Pluriel (drum brake) (LH/RH-SX/DX) (ch. 10423-)	02=>	867/1692	<b>07.1497</b>	4745Y9-474613-9680318380	0,422
C3 all (disc brake) (LH/RH-SX/DX)	09/09=>	1024/1803	<b>07.1770</b>	474660-9671815180	•
C3 all (drum brake) EP3C (LH/RH-SX/DX)	09/09=>	879/1706	<b>07.1771</b>	474659-9671814180	•
C3 all (drum brake) (exc. EP3C) (LH/RH-SX/DX)	09/09=>	882/1703	<b>07.1772</b>	474658-9671815380	•
C3 Picasso all (disc brake) (LH/RH-SX/DX)	09/09=>	1110/1910	<b>07.1773</b>	474654-9687063780	•
DS3 all (disc brake) (LH/RH-SX/DX)	09/09=>	1024/1803	<b>07.1770</b>	474660-9671815180	•
DS4 2,0 Hdi 16v manual park cable (LH/RH-SX/DX)	04/11=>	1205/2070	<b>07.1919</b>	474667-9688480980	0,562
DS4 all manual park cable (LH/RH-SX/DX)	04/11=>	1188/2033	<b>07.1623</b>	474631-9659391180	•
DS4 all electronic park cable (LH/RH-SX/DX)	04/11=>	665/830	<b>07.1942</b>	474656-474670-474677	0,283
C4 all (LH/RH-SX/DX)	99=>01	1447/1750	<b>07.0924</b>	4745C3	0,554
C4 Picasso (elettr. brake) (LH-SX)	05=>	750/928	<b>07.1566</b>	4745Z7-474634-9683025580	0,286
C4 Picasso (elettr. brake) (RH-DX)	05=>	770/959	<b>07.1567</b>	4745Z8-474635-9683025380	0,283
C4 2,0 Hdi (LH/RH-SX/DX)	10=>	1205/2070	<b>07.1919</b>	474667-9688480980	0,562
C4 all manual park cable (LH/RH-SX/DX)	10=>	1188/2033	<b>07.1623</b>	474631-9659391180	•
C4 (II) all electronic park cable (LH/RH-SX/DX)	10/10=>	665/830	<b>07.1942</b>	474656-474670-474677	0,283
C5 all (LH/RH-SX/DX)	10/00=>	475/1840	<b>07.0811</b>	4745R5	0,252
C5 all (manual brake) (LH/RH-SX/DX)	08=>	1442/2268	<b>07.1920</b>	474641-9682684580	•
ZX (drum brake) (RH-DX)	91=>	1171/1493	<b>07.346</b>	96032564-4745G1	0,347
ZX (drum brake) (LH-SX)	91=>	1260/1585	<b>07.347</b>	96032565-4745F8	0,368
ZX (disc brake) (LH-SX)	91=>	1342/1615	<b>07.349</b>	96032560-4745F6	0,412
ZX (disc brake) (RH-DX)	91=>	1260/1615	<b>07.354</b>	96032561-4745F9	0,369
ZX ABS mod. (drum brake) (LH-SX)	=>11/96	1260/1620	<b>07.0149</b>	4745F7-96145739	0,462
ZX ABS mod. (drum brake) (RH-DX)	=>11/96	1175/1530	<b>07.0159</b>	4745G0-96145740	0,429
ZX (drum brake) (ch. 7245) (RH-DX)	12/96=>	1175/1485	<b>07.0563</b>	4745K5-9628846980	0,495
ZX (drum brake) (ch. 7245) (LH-SX)	12/96=>	1265/1585	<b>07.0562</b>	4745K4-9628847080	0,512
ZX (disc brake) (RH-DX)	94=>	1270/1530	<b>07.0565</b>	4745K7-9628847280	0,471
ZX (disc brake) (LH-SX)	94=>	1350/1605	<b>07.0564</b>	4745K6-9628847180	0,556
ZX Break (drum brake) (LH-SX)	94=>	1170/1520	<b>07.0566</b>	4745K8-9628847480	0,507

**COMANDI FLESSIBILI FUNE FRENO A MANO - BRAKE CABLES - CABLES DE FREIN  
BREMSSEILE - CABLES DE FRENO - CABOS DE TRAVAO  
LINKI HAMULCA - BRZDOVÁ LANKA - ТРОСЫ РУЧНОГО ТОРМОЗА**

				OEM REF.	
<b>CITROEN</b>					
ZX Break (drum brake) (RH-DX)	94=>	1265/1610	<b>07.0567</b>	4745K9-9628847380	0,525
ZX all ABS mod.-Kit 2 pcs. (LH/RH-SX/DX)	94=>	1170/1530+ 1260/1620	<b>07.1604</b>	4745E8	•
GS/GSA all (LH-SX)	71=>	590/765	<b>07.546</b>	4225402	0,179
GS/GSA all (RH-DX)	71=>	600/775	<b>07.547</b>	4230002	0,321
Xsara 1,4-1,9 D-TD-HDI (drum brake) (LH-SX)	97=>	1280/1590	<b>07.0568</b>	4745J8	0,574
Xsara 1,4-1,9 D-TD-HDI (drum brake) (RH-DX)	97=>	1190/1500	<b>07.0569</b>	4745J9	0,534
Xsara 1,8-2,0 (disc brake) (LH-SX)	97=>	1375/1635	<b>07.0570</b>	4745K0	0,643
Xsara 1,8-2,0 (disc brake) (RH-DX)	97=>	1280/1545	<b>07.0571</b>	4745K1	0,582
Xsara 1,4-1,6 (drum brake) (LH-SX)	97=>	1260/1610	<b>07.0825</b>	4745K2	0,635
Xsara 1,4-1,6 (drum brake) (RH-DX)	97=>	1170/1520	<b>07.0826</b>	4745K3	0,596
Xsara Picasso all (LH-SX)	00=>	1500/1775	<b>07.0829</b>	4745P5-9633826680	0,573
Xsara Picasso all (RH-DX)	00=>	1590/1865	<b>07.0802</b>	4745P6-9633826780	0,602
Xsara Picasso all (disc brake) (LH-SX)	11/02=>	1645/1860	<b>07.1099</b>	4745W0-9643731880	0,627
Xsara Picasso all (disc brake) (RH-DX)	11/02=>	1735/1948	<b>07.1100</b>	4745W1-9643731980	0,697
Xsara Picasso all (disc brake) (LH-SX)	05=>	1645/1860	<b>07.1572</b>	4745Z5-9659013080	0,775
Xsara Picasso all (disc brake) (RH-DX)	05=>	1735/1950	<b>07.1573</b>	4745Z6-9659014080	0,800
Xsara Picasso all (disc brake) (LH-SX)	09/11=>	1498/1775	<b>07.1888</b>	474638-9664440680	•
Xsara Picasso all (disc brake) (RH-DX)	09/11=>	1589/1864	<b>07.1889</b>	474639-9664440780	•
BX all (LH/RH-SX/DX)	82=>	1485/1655	<b>07.945</b>	95496106-95611505	0,563
Xantia all (RH-DX)	93=>	1240/1360	<b>07.0501</b>	96121652-4745G6	0,540
Xantia all (LH-SX)	93=>	1170/1290	<b>07.0502</b>	96121653-4745G5	0,497
Xantia all T CT-TD 2,1 (RH-DX)	94=>	1266/1364	<b>07.0827</b>	4745J4	0,473
Xantia all T CT-TD 2,1 (LH-SX)	94=>	1140/1301	<b>07.0572</b>	4745H5	0,552
CX all (LH-SX)	74=>	1000/1190	<b>07.550</b>	5490304	0,358
CX all (RH-DX)	74=>	1185/1385	<b>07.551</b>	5490303	0,409
CX all (LH-SX)	80=>	1010/1200	<b>07.867</b>	95492972	0,365
CX all (RH-DX)	80=>	1220/1400	<b>07.866</b>	95492971	0,428
XM all (front-avt)	91=>	1110/1410	<b>07.360</b>	96012379	0,321
XM (RHD mod.) (front-avt)	91=>	738/963	<b>07.0573</b>	96026870	•
XM all (exc.24v) (RH-DX)	91=>	1145/1230	<b>07.363</b>	96026873	0,480
XM all (exc.24v) (LH-SX)	91=>	945/1030	<b>07.368</b>	96026875	0,420
XM (24v) (LH-SX)	91=>	900/1025	<b>07.0574</b>	96092761-96092671	0,406
XM (24v) (RH-DX)	91=>	1305/1390	<b>07.369</b>	96068340	0,493
Evasion LWB (front-avt)	94=>	653/903	<b>07.1101</b>	4745P0-1484385080	0,265
Evasion all (front-avt)	94=>	255/500	<b>07.0166</b>	4745E9-1472957080-4745T5 1487276080	0,132
Evasion (drum brake) (LH-SX)	94=>	770/1060	<b>07.0167</b>	4745F2-1473322080	1,065
Evasion (drum brake) (RH-DX)	94=>	2050/2310	<b>07.0168</b>	4745F3-1473321080	0,912
Evasion (LH-SX)	95=>	1065/1255	<b>07.0170</b>	4745F4-1472959080	0,444
Evasion (RH-DX)	95=>	2080/2205	<b>07.0169</b>	4745F5-1472958080	0,817
Evasion (RHD mod.) (LH-SX)	02/96=>	1096/1300	<b>07.0849</b>	4745R4-1483708080	0,537
Evasion (RHD mod.) (RH-DX)	02/96=>	1980/2105	<b>07.0850</b>	4745R3	0,933

**COMANDI FLESSIBILI FUNE FRENO A MANO - BRAKE CABLES - CABLES DE FREIN  
BREMSSEILE - CABLES DE FRENO - CABOS DE TRAVAO  
LINKI HAMULCA - BRZDOVÁ LANKA - ТРОСЫ РУЧНОГО ТОРМОЗА**

				<b>OEM REF.</b>	
---	---	---	--	-----------------	---

**CITROEN**





C8 all (front-avt)	06/02=>	255/500	<b>07.0166</b>	4745E9-1472957080-4745T5 1487276080	0,132
C8 all (RH-DX)	06/02=>	2220/2360	<b>07.1105</b>	4745T7-1487647080-4745T8 1487275080	0,807
C8 all (LH-SX)	06/02=>	840/1068	<b>07.1106</b>	4745T6-1487274080	0,326
C8 all (RH-DX)	05=>	2150/2310	<b>07.1341</b>	1400310280-1400310180 4745Y6-4745Y7	0,840
C8 all (LH-SX)	05=>	840/1041	<b>07.1342</b>	1400310380-4745Y8	0,408
C8 all (drum brake) (LH/RH-SX/DX)	06=>	1275/1495	<b>07.1922</b>	474610-1400203780	0,551
C8 all (disc brake) (LH/RH-SX/DX)	06=>	1467/1613	<b>07.1923</b>	474611-1400203680	0,536
C8 all (front-avt)	05=>	305/500	<b>07.1924</b>	474622-1400813580	0,140
C8 all MPV/VAN (LH/RH-SX/DX)	07=>	1115/1255	<b>07.1774</b>	474609-1400204180	0,478



**CITROEN - Commercial Vehicle**

Berlingo all (LH-SX)	96=>	1405/1745	<b>07.0575</b>	4745J0-96222503	0,518
Berlingo all (RH-DX)	96=>	1480/1820	<b>07.0576</b>	4745J3-96277119	0,527
Berlingo all (orga 08394-) (RH-DX)	97=>	1510/1850	<b>07.0828</b>	4745R0-96391792	0,530
Berlingo all	08=>	1300/2402	<b>07.1853</b>	474646	•
Berlingo all (disc brake) (RH-DX)	06/04=>	1640/1922	<b>07.1340</b>	4745Y1	0,707
Berlingo all (disc brake) (LH-SX)	06/04=>	1555/1820	<b>07.1339</b>	4745Y0	0,660
Nemo all BZ (RH-DX)	12/07=>	1442/1695	<b>07.1568</b>	474643	0,656
Nemo all BZ (LH-SX)	12/07=>	1407/1662	<b>07.1569</b>	474642	0,624
Nemo all D 1,4 Hdi (RH-DX)	12/07=>	1435/1710	<b>07.1570</b>	474645	0,655
Nemo all D 1,4 Hdi (LH-SX)	12/07=>	1402/1677	<b>07.1571</b>	464744	0,655
Jumpy all (front-avt)	95=>	255/500	<b>07.0166</b>	4745E9-1472957080-4745T5	0,132
Jumpy 1,6-D (drum brake) (LH-SX)	95=>	770/1063	<b>07.0167</b>	4745F2-1473322080	1,065
Jumpy 1,6-D (drum brake) (RH-DX)	95=>	2050/2310	<b>07.0168</b>	4745F3-1473321080	0,912
Jumpy LWB (RH-DX)	95=>	2145/2368	<b>07.1266</b>	4745G8	0,999
Jumpy TD (disc brake) (LH-SX)	95=>	1066/1255	<b>07.0170</b>	4745F4-1472959080	0,444
Jumpy TD (disc brake) (RH-DX)	95=>	2080/2205	<b>07.0169</b>	4745F5-1472958080	0,817
Jumpy (RHD mod.) (LH-SX)	02/96=>	1096/1300	<b>07.0849</b>	4745R4-1483708080	0,537
Jumpy (RHD mod.) (RH-DX)	02/96=>	1980/2105	<b>07.0850</b>	4745R3	0,933
Jumpy all (drum brake) (LH/RH-SX/DX)	06=>	1275/1495	<b>07.1922</b>	474610-1400203780	0,551
Jumpy all (SWB short) (LH/RH-SX/DX)	06=>	1467/1613	<b>07.1923</b>	474611-1400203680	0,536
Jumpy all (LWB long) (LH/RH-SX/DX)	06=>	1590/1730	<b>07.1882</b>	474612-1400204880	0,680
C15 all (LH/RH-SX/DX)	85=>	1183/2035	<b>07.790</b>	95610161-95610162-9561016180	0,406
C15 D all (LH/RH-SX/DX)		1705	<b>07.1149</b>	4745N7-9563577180	0,340
C15 all (exc.D) (LH/RH-SX/DX)		1250/1720	<b>07.1150</b>	4745N6	0,373
C25 (front-avt)	81=>	1430/1620	<b>07.797</b>	ZF4359202	0,574
C25	81=>	715+715/ 2590	<b>07.796</b>	ZF4450938	0,554
C35/C32 all (LH/RH-SX/DX)	=>80	710/915	<b>07.159</b>	ZF5455064	0,226
C35/C32 all	80=>	710/915	<b>07.886</b>	ZF75492188	0,226

**COMANDI FLESSIBILI FUNE FRENO A MANO - BRAKE CABLES - CABLES DE FREIN  
BREMSEILE - CABLES DE FRENO - CABOS DE TRAVAO  
LINKI HAMULCA - BRZDOVÁ LANKA - ТРОСЫ РУЧНОГО ТОРМОЗА**

				OEM REF.	
<b>CITROEN - Commercial Vehicle</b>					
C35 (5 speed)	82=>	850/1045	<b>07.151</b>	95495405	0,259
Jumper all (front-avt)	94=>	761/1059	<b>07.0171</b>	4745G2-1308638080	0,468
Jumper all	94=>	810+810/ 3025	<b>07.0172</b>	4745G3-1307963080	0,748
Jumper all (Camping Car)	94=>	810+810/ 3040	<b>07.0830</b>	4745G7-1314983080	0,699
Jumper 4x4	94=>	1410+1410/ 4095	<b>07.1344</b>	4745J2	1,154
Jumper all (front-avt)	01=>	761/1078	<b>07.1110</b>	4745V6-1336889080	0,484
Jumper all (ch. 16158428-)	=>01	865+865/ 2806	<b>07.1363</b>	4745V2-1330058080	0,748
Jumper all (drum brake)	01=>	875+875/ 2825	<b>07.1365</b>	4745V5-1337440080	0,693
Jumper all (disc brake)	01=>	890+890/ 2715	<b>07.1366</b>	4745V4-4745W5-1339676080 1339394080	0,838
Jumper/Relay 4x4 (only UK) (front-avt)	=>02	843/1170	<b>07.1343</b>	4745V7-1337455080	•
Jumper/Relay 4x4 (only UK) (front-avt)	=>02	900/1140	<b>07.1164</b>	4745G4-1310462080	•
Jumper II all (front-avt)	02=>	645/1463	<b>07.1345</b>	4745W6-1338683080	0,404
Jumper II all (disc brake) (LH/RH-SX/DX)	02=>	782/955	<b>07.1346</b>	4745W7-1338691080	0,376
Jumper III all 30-33-35 (LH/RH-SX/DX)	06=>	1075/1385	<b>07.1883</b>	474617-1341031080	0,486
Jumper III all 40 (LH/RH-SX/DX)	06=>	1170/1480	<b>07.1925</b>	474618-1348980080	0,459
Jumper III all 33-35 passo 3450 (front-avt)	06=>	2035/2295	<b>07.1926</b>	474627-1350313080	0,895
Jumper III p. 3800/3800 Fap mod. (front-avt)	06=>	2390/2645	<b>07.1676</b>	474629-474650-1350314080 1359247080	1,005
Jumper III p. 3000/3000 Fap mod. (front-avt)	06=>	1650/1910	<b>07.1677</b>	474647-4745Z9-1341023080 1359245080	0,763
Jumper III 40 p. 4035/4035 Fap mod. (front-avt)	06=>	2650/2910	<b>07.1678</b>	474649-474628-1350315080 1359248080	1,399





**DAIHATSU**

Charade G30	85=>86	1080/1215	<b>07.0121</b>	4642087702	0,388
Charade G100 (LH-SX)	88=>91	1335/1510	<b>07.0833</b>	4643087701	•
Charade G100 (RH-DX)	88=>91	1365/1543	<b>07.0834</b>	4642087706	•
Charmant A35-A45 (LH-SX)	82=>83	835/1355	<b>07.0073</b>	4643012130000	0,397
Charmant A35-A45 (RH-DX)	82=>83	730/1345	<b>07.0074</b>	4642012230000	0,347
Charmant (LH-SX)	08/83=>	835/1325	<b>07.0123</b>	4643012180000	0,337
Charmant (RH-DX)	08/83=>	730/1315	<b>07.0124</b>	4642012280000	0,329
Charmant (front-avt)	08/83=>	340	<b>07.1467</b>	4641012120000	•





**FERRARI**

308 GT			<b>07.0590</b>	105779	•
308 GT			<b>07.0591</b>	105793	•
308 GT			<b>07.0592</b>	105792	•
Dino			<b>07.0593</b>	680901	•
Dino			<b>07.0594</b>	680902	•
Dino			<b>07.0595</b>	680903	•
308			<b>07.0596</b>	106482	•
308			<b>07.0597</b>	129114	•





**COMANDI FLESSIBILI FUNE FRENO A MANO - BRAKE CABLES - CABLES DE FREIN  
BREMSSEILE - CABLES DE FRENO - CABOS DE TRAVAO  
LINKI HAMULCA - BRZDOVÁ LANKA - ТРОСЫ РУЧНОГО ТОРМОЗА**

				OEM REF.	
<b>FIAT</b>					
500 F-L	64=>	715+715/ 2335	<b>07.101</b>	4104963	0,684
500 R	73=>	715+715/ 2335	<b>07.101</b>	4296434	0,684
500 D-F-Giardiniera	64=>	725+725/ 2560	<b>07.103</b>	4104964	0,683
126 all	73=>	735+735/ 2360	<b>07.100</b>	4273200-92502088	0,683
126 Bis all	87=>	780+780/ 2350	<b>07.977</b>	4345508	0,714
Cinquecento all	92=>	1250+1215/ 3000	<b>07.068</b>	7684513	1,015
Cinquecento all	98=>	1105+1105/ 2635	<b>07.0598</b>	46517955	0,971
500 (New) all 1,2-1,3 Mjt (RH-DX)	07=>	1202/1450	<b>07.1574</b>	51786839	0,483
500 (New) all 1,2-1,3 Mjt (LH-SX)	07=>	1176/1425	<b>07.1575</b>	51786840	•
500 (New) 1,4 all (disc brake) (LH-SX)	07=>	1280/1490	<b>07.1576</b>	51753526	•
500 (New) 1,4 all (disc brake) (RH-DX)	07=>	1300/1505	<b>07.1577</b>	51753527	0,525
500 Abarth all (disc brake) (LH-SX)	07=>	1280/1490	<b>07.1576</b>	51753526-51826232	•
500 Abarth all (disc brake) (RH-DX)	07=>	1300/1505	<b>07.1577</b>	51753527-51826363	0,525
500L (LH/RH-SX/DX)	09/12=>	1560/1775	<b>07.2003</b>	51931536-51931537	•
600 all	=>63	195/660	<b>07.104</b>	875120	0,190
600 D-E	64=>	570+570/ 2570	<b>07.105</b>	4104882-4046523	0,576
Seicento all	98=>	1105+1105/ 2635	<b>07.0598</b>	46517955	0,971
850 all	64=>	280+280/ 1580	<b>07.113</b>	4113083	0,340
Panda all	80=>	1035+1035/ 2690	<b>07.676</b>	4406021	0,848
Panda 750-1000-4x4	86=>	970+970/ 2400	<b>07.102</b>	7573814	0,748
Panda all (exc. 4WD)	92=>	950+950/ 2385	<b>07.757</b>	7757560	0,796
Panda (New) (RH-DX)	03=>	1190/1430	<b>07.1151</b>	51708685	0,498
Panda (New) (LH-SX)	03=>	1165/1400	<b>07.1152</b>	51708686	0,472
Panda 1,3 Mjtd 75cv (LH-SX)	03=>	1165/1400	<b>07.1777</b>	51776597	•
Panda 1,3 Mjtd 75cv (RH-DX)	03=>	1190/1425	<b>07.1778</b>	51776598	•
Panda (New) 4x4 (RH-DX)	03=>	1258/1471	<b>07.1347</b>	46829766	0,501
Panda (New) 4x4 (LH-SX)	03=>	1270/1485	<b>07.1348</b>	46829767	0,505
Panda 1,4 all (disc brake) (LH-SX)	06=>	1280/1490	<b>07.1576</b>	51753526-51826232	•
Panda 1,4 all (disc brake) (RH-DX)	06=>	1300/1505	<b>07.1577</b>	51753527-51826363	0,525
Panda all 1,2ie natural power (RH-DX)	12/06=>	1194/1457	<b>07.1688</b>	51787259	0,487
Panda all 1,2ie natural power (LH-SX)	12/06=>	1178/1437	<b>07.1689</b>	51787260	0,478
Panda (III) all (RH-DX)	12=>	1175/1435	<b>07.1947</b>	51900391	•
Panda (III) all (LH-SX)	12=>	1165/1425	<b>07.1948</b>	51900393	•
127 all (exc. Brasil mod.)	74=>	845+845/ 2315	<b>07.117</b>	4261125-4261126	0,736
127 D-Panorama-Brazil	81=>	835+835/ 2315	<b>07.663</b>	4362077	0,747
Uno all (exc.T) (LH-SX)	83=>	330/505	<b>07.822</b>	5951339	0,182
Uno all (exc.T) (RH-DX)	83=>	327/2025	<b>07.821</b>	5951342	0,230





**COMANDI FLESSIBILI FUNE FRENO A MANO - BRAKE CABLES - CABLES DE FREIN  
BREMSSEILE - CABLES DE FRENO - CABOS DE TRAVAO  
LINKI HAMULCA - BRZDOVÁ LANKA - ТРОСЫ РУЧНОГО ТОРМОЗА**

				OEM REF.	
<b>FIAT</b>					
Uno Smart	87=>	1175+1175/ 2840	<b>07.148</b>	5969735	0,942
Uno Cs	87=>	1175+1175/ 2840	<b>07.148</b>	5969735	0,942
Uno all (exc.T) (LH-SX)	89=>90	340/540	<b>07.005</b>	7661241	0,171
Uno all (exc.T) (Plastic Covered) (RH-DX)	89=>90	327/2025	<b>07.0599</b>	5951342	0,232
Uno all (exc.T) (LH-SX)	05/90=>	330/540	<b>07.175</b>	7671310	0,173
Uno all (exc.T) (RH-DX)	05/90=>	310/2020	<b>07.176</b>	7671309	0,238
Uno T ie (LH-SX)	85=>	415/565	<b>07.116</b>	7551507	0,180
Uno T ie (RH-DX)	85=>	410/2120	<b>07.121</b>	7551506	0,232
Uno T ie (LH-SX)	89=>	520/595	<b>07.006</b>	7661244	0,171
Uno T ie (Plastic Covered) (RH-DX)	89=>	390/2100	<b>07.0611</b>	7551506	0,252
Uno CS	92=>	1175+1175/ 2840	<b>07.762</b>	7522590-50003039	0,908
Premio	85=>	1175+1175/ 2840	<b>07.762</b>	7522590-50003039	0,908
Duna all	87=>	1175+1175/ 2840	<b>07.148</b>	5969735	0,942
Duna all	92=>	1175+1175/ 2840	<b>07.762</b>	7522590-50003039	0,908
Punto all (exc. GT) (LH-SX)	11/93=>	1310/1480	<b>07.759</b>	7747332	0,530
Punto all (exc. GT) (RH-DX)	11/93=>	1315/1495	<b>07.760</b>	7747331	0,542
Punto GT (LH/RH-SX/DX)	11/93=>	1420/1550	<b>07.761</b>	7747333-7747334	0,576
Punto 1,2-1,9 D (LH/RH-SX/DX)	99=>	1230/1455	<b>07.0840</b>	46752977-46752983	0,527
Punto 1,8 16v (LH/RH-SX/DX)	99=>	1388/1588	<b>07.0841</b>	46552978-46752984	0,572
Punto (New) FL03 1,4 16v-1,9 Jtd 74Kw (drum brake) (LH/RH-SX/DX)	03=>	1235/1450	<b>07.1153</b>	46845902	0,495
Grande Punto all 1,2 8/16v (drum brake) (RH-DX)	10/05=>	1392/1659	<b>07.1350</b>	55700926	0,536
Grande Punto all 1,2 8/16v (drum brake) (LH-SX)	10/05=>	1375/1641	<b>07.1351</b>	55700928	0,548
Grande Punto all 1,4 8v (drum brake) (RH-DX)	10/05=>	1388/1689	<b>07.1352</b>	55701946	0,517
Grande Punto all 1,4 8v (drum brake) (LH-SX)	10/05=>	1372/1673	<b>07.1353</b>	55701942	0,522
Grande Punto all 1,9 Jtd (disc brake) (RH-DX)	10/05=>	1440/1673	<b>07.1354</b>	55700927	0,545
Grande Punto all 1,9 Jtd (disc brake) (LH-SX)	10/05=>	1422/1654	<b>07.1355</b>	55700929	0,559
Punto Abarth (LH-SX)	11/09=>	1422/1641	<b>07.1890</b>	50519022-51871599-51844531	•
Punto Abarth (RH-DX)	11/09=>	1440/1658	<b>07.1891</b>	50519020-51871598	•
Palio/Siena all (LH-SX)	97=>	1290/1515	<b>07.0613</b>	46431514-46542604	0,601
Palio/Siena all (RH-DX)	97=>	1240/1465	<b>07.0612</b>	46464658	0,574
Palio/Siena all (Sud America) (RH-DX)	97=>	1250/1465	<b>07.1500</b>	7798268	0,536
Palio/Siena all (Sud America) (LH-SX)	97=>	1295/1520	<b>07.1501</b>	46437961	0,555
Palio all (LH/RH-SX/DX)	99=>	1163/1400	<b>07.1154</b>	46799091-46799093	0,500
Palio/Siena all (LH-SX)	05=>	1277/1501	<b>07.1357</b>	46847416	•
Palio/Siena all (RH-DX)	05=>	1285/1511	<b>07.1356</b>	46847417	0,561
Idea 1,2 16v-1,4 16v-1,3 Sdi (LH/RH-SX/DX)	03=>	1305/1530	<b>07.1155</b>	51731443	0,492
Idea 1,9 Jtd 74 kw (LH/RH-SX/DX)	03=>	1305/1555	<b>07.1156</b>	46847434	0,498
Idea all Mjtd 16v	04/08=>	1423/1618	<b>07.1685</b>	51804860	0,541
1100-1100 D/1200	=>65	860+860/ 3130	<b>07.123</b>	4052933	0,854
1100 R (I° s.)	=>65	745+745/ 3030	<b>07.124</b>	4141308	0,771





**COMANDI FLESSIBILI FUNE FRENO A MANO - BRAKE CABLES - CABLES DE FREIN  
BREMSEILE - CABLES DE FRENO - CABOS DE TRAVAO  
LINKI HAMULCA - BRZDOVÁ LANKA - ТРОСЫ РУЧНОГО ТОРМОЗА**

				OEM REF.	
<b>FIAT</b>					
1100 R (II° s.)	66=>71	740+740/ 2980	<b>07.125</b>	4170237	0,819
128 all	07/71=>	765+765/ 2030	<b>07.122</b>	4261121-4261122	0,699
X 1/9	72=>	675/965	<b>07.661</b>	4264913	0,300
Ritmo all (front-avt)	78=>	890	<b>07.535</b>	4403012	0,217
Ritmo all	78=>	805+805/ 2165	<b>07.536</b>	4387206	0,688
Ritmo all	82=>	505+505/ 3510	<b>07.819</b>	5939145	0,226
Ritmo all (front-avt)	82=>	405	<b>07.820</b>	5939142	0,069
Ritmo Cabrio	84=>	390+390/ 3195	<b>07.150</b>	5961349	0,763
Tipo 1,1-1,4-1,5-D (drum brake) (LH-SX)	88=>	1065/1425	<b>07.156</b>	7615327-92323734	0,446
Tipo 1,1-1,4-1,5-D (drum brake) (RH-DX)	88=>	1025/1385	<b>07.154</b>	7615326-92323733	0,430
Tipo all (front-avt)	88=>	405	<b>07.149</b>	7609367-92323732-46410282	0,112
Tipo 1,6-TD (LH-SX)	88=>	1070/1470	<b>07.996</b>	7615339	0,466
Tipo 1,6-TD (RH-DX)	88=>	1030/1420	<b>07.995</b>	7615338	0,428
Tipo 16v antiskid (disc brake) (LH-SX)	88=>	1175/1520	<b>07.999</b>	7615343	0,467
Tipo 16v antiskid (disc brake) (RH-DX)	88=>	1135/1440	<b>07.997</b>	7615342	0,432
Tipo 16v antiskid (disc brake) (LH-SX)	92=>93	1160/1517	<b>07.0427</b>	7714822	0,505
Bravo/Brava 1,4 (drum brake) (LH-SX)	95=>	1050/1425	<b>07.0420</b>	7773001-46468158	0,452
Bravo/Brava 1,4 (drum brake) (RH-DX)	95=>	995/1370	<b>07.0421</b>	46468157-7773000	0,469
Bravo/Brava all (front-avt)	95=>	385	<b>07.0419</b>	7773616	0,117
Bravo/Brava 1,6-1,8-D (LH-SX)	95=>96	1045/1428	<b>07.0603</b>	7791233	0,432
Bravo all 2,0 (disc brake) (RH-DX)	95=>96	1102/1448	<b>07.0604</b>	46414289	0,473
Bravo all 2,0 (disc brake) (LH-SX)	95=>96	1137/1488	<b>07.0605</b>	46404218	0,502
Bravo/Brava 1,6-1,8-D Antiskid (RH-DX)	96=>	995/1385	<b>07.0423</b>	46468155-46465194-7791231	0,476
Bravo/Brava 1,6-1,8-D Antiskid (LH-SX)	96=>	1040/1430	<b>07.0422</b>	46468156-46465947	0,452
Bravo all 2,0 (disc brake) (RH-DX)	96=>	1110/1460	<b>07.0428</b>	46465949-46460478	0,505
Bravo all 2,0 (disc brake) (LH-SX)	96=>	1155/1517	<b>07.0427</b>	46465948-46460508-7714822	0,505
Bravo all (RH-DX)	07=>	1480/1660	<b>07.1928</b>	51718093	0,612
124-124 S	66=>	760+760/ 2200	<b>07.126</b>	4144494-4153287	0,653
124 Coupé-Spyder	66=>	720+715/ 2040	<b>07.127</b>	4151692	0,693
124-124 S (front-avt)	66=>	475	<b>07.128</b>	4144491	0,062
124 Coupé-Spyder (front-avt)	66=>	372	<b>07.130</b>	4162304	0,074
131 all	74=>	1205+1110/ 2895	<b>07.133</b>	4328812	0,914
131 all (front-avt)	74=>	270	<b>07.134</b>	4329622	0,042
Regata all	82=>	505+505/ 3510	<b>07.819</b>	5939145	0,226
Regata all (front-avt)	82=>	405	<b>07.820</b>	5939142	0,069
Tempra all (front-avt)	88=>	405	<b>07.149</b>	7609367-92323732-46410282	0,112
Tempra 1,1-1,4-1,5-D (drum brake) (LH-SX)	88=>	1065/1425	<b>07.156</b>	7615327-92323734	0,446
Tempra 1,1-1,4-1,5-D (drum brake) (RH-DX)	88=>	1025/1385	<b>07.154</b>	7615326-92323733	0,430

**COMANDI FLESSIBILI FUNE FRENO A MANO - BRAKE CABLES - CABLES DE FREIN  
BREMSSSEILE - CABLES DE FRENO - CABOS DE TRAVAO  
LINKI HAMULCA - BRZDOVÁ LANKA - ТРОСЫ РУЧНОГО ТОРМОЗА**

				OEM REF.	
<b>FIAT</b>					
Tempra antiskid (disc brake) (LH-SX)	88=>	1175/1520	<b>07.999</b>	7615343	0,467
Tempra antiskid (disc brake) (RH-DX)	88=>	1135/1440	<b>07.997</b>	7615342	0,432
Tempra 1,6-TD (LH-SX)	88=>	1070/1470	<b>07.996</b>	7615339	0,466
Tempra 1,6-TD (RH-DX)	88=>	1030/1420	<b>07.995</b>	7615338	0,428
Tempra antiskid (disc brake) (LH-SX)	92=>93	1160/1517	<b>07.0427</b>	7714822	0,505
Tempra antiskid (disc brake) (RH-DX)	93=>	1120/1460	<b>07.329</b>	46456850	0,494
Tempra antiskid (disc brake) (LH-SX)	93=>	1170/1520	<b>07.0431</b>	46401730-46456849	0,482
125 all	66=>	675+655/ 2460	<b>07.129</b>	4169895-4294024	0,800
125 all (front-avt)	66=>	372	<b>07.130</b>	4162304	0,074
132 all	=>02/77	675+655/ 2460	<b>07.129</b>	4294024	0,800
132 all	03/77=>	755+775/ 2800	<b>07.530</b>	4357023	0,834
Argenta all (front-avt)	81=>	450	<b>07.787A</b>	5927360	0,052
Argenta all	81=>	760+780/ 2700	<b>07.787</b>	5923974	0,942
Argenta all	83=>	695+695/ 2390	<b>07.951</b>	5967866	0,865
Croma all (front-avt)	86=>	265	<b>07.131</b>	82399827-60807617	0,049
Croma all	86=>	1260+1400/ 2970	<b>07.132</b>	82390671-82441688	1,025
Croma all (with prot.)	92=>	1260+1400/ 2970	<b>07.097</b>	82481842-46408830	1,162
Croma (New) 1,9 Jtd-2,4 Jtd	05=>	1454/1630+ 1397/1587	<b>07.1358</b>	51753207	•
Croma (New) 2,2 16v	05=>	1395/1570+ 1455/1625	<b>07.1502</b>	51753208	•
Marea 1,4 all (drum brake) (RH-DX)	96=>	995/1370	<b>07.0421</b>	7773000-46455422	0,469
Marea 1,4 all (drum brake) (LH-SX)	96=>	1050/1425	<b>07.0420</b>	7773001-46462766	0,452
Marea 1,6 (drum brake) (RH-DX)	96=>	1000/1405	<b>07.0614</b>	46463911	0,441
Marea 1,6 (drum brake) (LH-SX)	96=>	1055/1460	<b>07.0615</b>	46463910	0,438
Marea 1,6-1,8 antiskid (RH-DX)	96=>	995/1385	<b>07.0602</b>	7791231-46465194	0,748
Marea 1,6-1,8 antiskid (LH-SX)	96=>	1040/1430	<b>07.0422</b>	46468156-46465947	0,452
Marea TD 75-100cv (exc.TD 2,4) (RH-DX)	96=>	995/1385	<b>07.0602</b>	7791231-46465194	0,748
Marea TD 75-100cv (exc.TD 2,4) (LH-SX)	96=>	1040/1430	<b>07.0422</b>	46468156-46465947	0,452
Marea 2,0 all-2,4 TD (disc brake) (RH-DX)	96=>	1110/1460	<b>07.0428</b>	46465949-46460478	0,505
Marea 2,0 all-2,4 TD (disc brake) (LH-SX)	96=>	1155/1517	<b>07.0427</b>	46465948-46460508-7714822	0,505
Marea all (front-avt)	96=>	385	<b>07.0419</b>	7773616	0,117
Stilo all (RH-DX)	01=>	1455/1640	<b>07.0842</b>	46819336	0,585
Stilo all (LH-SX)	01=>	1600/1785	<b>07.0843</b>	46819335-51702642	0,626
Stilo all (RH-DX)	04=>	1480/1660	<b>07.1928</b>	51718093	0,612
Linea all (LH-SX)	07=>	1437/1712	<b>07.1578</b>	51785645	•
Linea all (RH-DX)	07=>	1450/1725	<b>07.1579</b>	51785644	•
Linea all 1,4 T 16v (disc brake) (RH-DX)	07=>	1330/1520	<b>07.1686</b>	51787024	0,546
Linea all 1,4 T 16v (disc brake) (LH-SX)	07=>	1325/1515	<b>07.1687</b>	51787025	0,593
Barchetta all (disc brake) (LH/RH-SX/DX)	96=>	1385/1520	<b>07.0429</b>	46731055	0,569

**COMANDI FLESSIBILI FUNE FRENO A MANO - BRAKE CABLES - CABLES DE FREIN  
BREMSSEILE - CABLES DE FRENO - CABOS DE TRAVAO  
LINKI HAMULCA - BRZDOVÁ LANKA - ТРОСЫ РУЧНОГО ТОРМОЗА**

				OEM REF.	
<b>FIAT</b>					
Coupé all ( <b>front-avt</b> )	94=>	405	<b>07.149</b>	7609367-46410282	0,112
Coupé all (disc brake) (RH-DX)	94=>	1120/1475	<b>07.0430</b>	46401725	0,479
Coupé all (disc brake) (LH-SX)	94=>	1170/1520	<b>07.0431</b>	46401730-46456849	0,482
Dino 2,4	1030+1030/ 3300		<b>07.0314</b>		0,967
Sedici 1,6 BZ-1,9 Jtd Pv 120cv (RH-DX)	06=>	1565/1795	<b>07.1498</b>	71742844	•
Sedici 1,6 BZ-1,9 Jtd Pv 120cv (LH-SX)	06=>	1555/1785	<b>07.1499</b>	71742845	•
Sedici all (disc brake) (RH-DX)	06=>	1455/1635	<b>07.2004</b>	71750424	•
Sedici all (disc brake) (LH-SX)	06=>	1455/1635	<b>07.2005</b>	71750425	•
Freemont all ( <b>front-avt</b> )	08/11=>	1655/1920	<b>07.1667</b>	K04766479AD-K04766479AC	•
Freemont all (RH-DX)	11=>	1095/2300	<b>07.1668</b>	K04862226AF-K04862226AE	•
Freemont all (LH-SX)	11=>	980/1177	<b>07.1669</b>	K04862227AH-K04862227AG K04862227AI-K04862227AJ	•
Multipla 100-105 all ( <b>front-avt</b> )	98=>	685	<b>07.0800</b>	46514278	0,143
Multipla 100 16v-105 Jtd (LH-SX)	98=>	820/1165	<b>07.0801</b>	46511039-46757058	0,387
Multipla 100 16v-105 Jtd (RH-DX)	98=>	1668/2014	<b>07.0846</b>	46547547	0,644
Multipla 1,6 16v Bi/Blupower (LH-SX)	98=>	800/1143	<b>07.0847</b>	60654885	0,377
Multipla 1,6 16v Bi/Blupower (RH-DX)	98=>	1718/2063	<b>07.0848</b>	60664187	0,671
Multipla all (disc brake) (RH-DX)	98=>	1790/2081	<b>07.1157</b>	46814148	0,680
Multipla all (disc brake) (LH-SX)	98=>	930/1220	<b>07.1158</b>	46814147	0,408
Multipla all (RHD mod.) (disc brake) (RH-DX)	98=>	2155/2326	<b>07.1159</b>	46825397	•
Multipla all (RHD mod.) (disc brake) (LH-SX)	98=>	1101/1271	<b>07.1160</b>	46825396	0,477
Multipla all (RHD mod.) ( <b>front-avt</b> )	98=>	590	<b>07.1161</b>	46556690	•
Multipla (exc. Bi/Blupower) RHD mod. (LH-SX)	98=>	987/1211	<b>07.1162</b>	46556688	•
Multipla (exc. Bi/Blupower) RHD mod. (RH-DX)	98=>	2040/2266	<b>07.1163</b>	46556689	0,838
Ulysse all ( <b>front-avt</b> )	94=>	255/500	<b>07.0166</b>	1472957080-4745E9-4745T5 1487276080	0,132
Ulysse 2,0-TD (drum brake) (LH-SX)	94=>	770/1065	<b>07.0167</b>	4745F2-1473322080	1,065
Ulysse 2,0-TD (drum brake) (RH-DX)	94=>	2050/2310	<b>07.0168</b>	4745F3-1473321080	0,912
Ulysse TB (disc brake) (RH-DX)	95=>	2080/2205	<b>07.0169</b>	1472958080-4745F5	0,817
Ulysse TB (disc brake) (LH-SX)	95=>	1060/1255	<b>07.0170</b>	1472959080-4745F4	0,444
Ulysse 2,0-TD (drum brake) (LH-SX)	04/00=>	1096/1300	<b>07.0849</b>	1483708080-4745R4	0,537
Ulysse 2,0-TD (drum brake) (RH-DX)	04/00=>	1980/2105	<b>07.0850</b>	4745R3	0,933
Ulysse all (RH-DX)	06/02=>	2220/2360	<b>07.1105</b>	4745T8-4745T7-1487647080 1487275080	0,807
Ulysse all (LH-SX)	06/02=>	840/1068	<b>07.1106</b>	4745T6-1487274080	0,326
Ulysse all (RH-DX)	05=>	2150/2310	<b>07.1341</b>	1400310280-1400310180 4745Y6-4745Y7	0,840
Ulysse all (LH-SX)	05=>	840/1041	<b>07.1342</b>	1400310380	0,408
Ulysse all (drum brake) (LH/RH-SX/DX)	06=>	1275/1495	<b>07.1922</b>	1400203780-474610	0,551
Ulysse all (disc brake) (LH/RH-SX/DX)	06=>	1467/1613	<b>07.1923</b>	1400203680-474611	0,536
Ulysse all ( <b>front-avt</b> )	05=>	305/500	<b>07.1924</b>	1400813580-474622	0,140
Ulysse 2,0 Jtd (disc brake) (LH/RH-SX/DX)	03/07=>	1115/1255	<b>07.1774</b>	1400204180	0,478

**COMANDI FLESSIBILI FUNE FRENO A MANO - BRAKE CABLES - CABLES DE FREIN  
BREMSSEILE - CABLES DE FRENO - CABOS DE TRAVAO  
LINKI HAMULCA - BRZDOVÁ LANKA - ТРОСЫ РУЧНОГО ТОРМОЗА**







OEM REF.







**FIAT - Commercial Vehicle**

600 DM	60=>	560+560/ 2000	<b>07.167</b>	4051979	0,560
600 T-850 T-900 T (front-avt)	=>79	1340	<b>07.111</b>	4116077	0,974
900 T	80=>	760+760/ 2170	<b>07.665</b>	4447750	•
Fiorino 900-1050	78=>	845+845/ 2315	<b>07.117</b>	4261126-4261125	0,736
Fiorino D	78=>	835+835/ 2315	<b>07.663</b>	4362077	0,747
Fiorino D	88=>	1175+1175/ 2840	<b>07.148</b>	5969735	0,942
Fiorino all	92=>	1175+1175/ 2840	<b>07.762</b>	7522590	0,908
Fiorino all	93=>	1205+1205/ 3105	<b>07.763</b>	7739156	1,000
Fiorino all (BZ) (RH/DX)	12/07=>	1442/1695	<b>07.1568</b>	51784533	0,656
Fiorino all (BZ) (LH/SX)	12/07=>	1407/1662	<b>07.1569</b>	51784535	0,624
Fiorino all D 1,3 MJ (RH-DX)	12/07=>	1435/1710	<b>07.1570</b>	51784534	0,655
Fiorino all D 1,3 MJ (LH-SX)	12/07=>	1402/1677	<b>07.1571</b>	51784536	0,655
Strada Pick-Up (RH-DX)	02=>	1448/1710	<b>07.1583</b>	46471701	•
Strada Pick-Up (LH-SX)	02=>	1448/1710	<b>07.1584</b>	46471702	0,703
238		670+670/ 2480	<b>07.157</b>	4197683	•
241 N (front-avt)		505	<b>07.155</b>	4067925	0,045
241 N-TN		740+825/ 1935	<b>07.158</b>	4153853	0,756
242-242 E		710/915	<b>07.159</b>	5455064-5435855	0,226
242 E (5 speed)	82=>	850/1045	<b>07.151</b>	95495405	0,259
Scudo Lwb mod. (front-avt)	94=>	653/903	<b>07.1101</b>	4745P0-1484385080	0,265
Scudo all (front-avt)	95=>	255/500	<b>07.0166</b>	1472957080-4745E9	0,132
Scudo 1,6-D (drum brake) (LH-SX)	95=>	770/1065	<b>07.0167</b>	4745F2-1473322080	1,065
Scudo 1,6-D (drum brake) (RH-DX)	95=>	2050/2310	<b>07.0168</b>	4745F3-1473321080	0,912
Scudo TD (disc brake) (RH-DX)	95=>	2080/2205	<b>07.0169</b>	1472958080-4745F5	0,817
Scudo TD (disc brake) (LH-SX)	95=>	1065/1255	<b>07.0170</b>	1472959080-4745F4	0,444
Scudo all (drum brake) (LH/RH-SX/DX)	06=>	1275/1495	<b>07.1922</b>	1400203780-474610	0,551
Scudo (SWB short) (LH/RH-SX/DX)	06=>	1467/1613	<b>07.1923</b>	1400203680-474611	0,536
Scudo (LWB long) (LH/RH-SX/DX)	06=>	1590/1730	<b>07.1882</b>	474612-1400204880	0,680
Doblò all 1,6 16v Bipower	03/01=>	1495/1755	<b>07.1359</b>	51706677	0,640
Doblò Van all (LH-SX)	03/01=>	1475/1810	<b>07.0845</b>	46766309	0,632
Doblò Panorama/Combinato (RH-DX)	03/05=>	1470/1780	<b>07.1361</b>	46835328-46766308	0,622
Doblò Panorama all (LH-SX)	03/05=>	1465/1755	<b>07.0844</b>	46745157	0,556
Doblò Panorama/Combinato (RH-DX)	03/05=>	1447/1740	<b>07.1360</b>	46835327	0,561
Doblò Maxi Combi all (RH-DX)	03/05=>	1800/2130	<b>07.1670</b>	51796639	0,708
Doblò Maxi Combi all (LH-SX)	03/05=>	1790/2115	<b>07.1671</b>	51796642	0,730





**COMANDI FLESSIBILI FUNE FRENO A MANO - BRAKE CABLES - CABLES DE FREIN  
BREMSSEILE - CABLES DE FRENO - CABOS DE TRAVAO  
LINKI HAMULCA - BRZDOVÁ LANKA - ТРОСЫ РУЧНОГО ТОРМОЗА**

				OEM REF.	
<b>FIAT - Commercial Vehicle</b>					
Doblò Maxi Combi BiPower	03/05=>	1845/2130	<b>07.1684</b>	51816315	0,751
Doblò Maxi Van/Furgone all (RH-DX)	03/05=>	1850/2135	<b>07.1672</b>	51750480	0,712
Doblò Maxi Van/Furgone all (LH-SX)	03/05=>	1850/2130	<b>07.1673</b>	51750481	0,705
Doblò Maxi Van/Furgone all BiPower	03/05=>	1845/2130	<b>07.1684</b>	51816315	0,751
Doblò Panorama/Combi SWB-Doblò Cargo SWB Esp/Asr mod. (LH/RH-SX/DX)	10/09=>	1555/1850	<b>07.1892</b>	51882836-51868725	•
Doblò Panorama/Combi SWB-Doblò Cargo SWB Esp/Asr mod. (LH/RH-SX/DX)	10/09=>	1555/1830	<b>07.1893</b>	51882838-51868727	•
Doblò Cargo (152) Bipower LWB all (LH/RH-SX/DX)	10/09=>	1938/2223	<b>07.1944</b>	51882840	0,737
Doblò Cargo (152) Bipower SWB all (LH/RH-SX/DX)	10/09=>	1585/1872	<b>07.1945</b>	51882839	0,627
Doblò Cargo Maxi LWB all (LH/RH-SX/DX)	10/09=>	1898/2182	<b>07.1946</b>	51882837-51868726	0,700
Qubo 1,4 BZ MPI 8v (RH/DX)	12/07=>	1442/1695	<b>07.1568</b>	51784533	0,656
Qubo 1,4 BZ MPI 8v (LH/SX)	12/07=>	1407/1662	<b>07.1569</b>	51784535	0,624
Qubo 1,3 Mjtd (RH-DX)	12/07=>	1435/1710	<b>07.1570</b>	51784534	0,655
Qubo 1,3 Mjtd (LH-SX)	12/07=>	1402/1677	<b>07.1571</b>	51784536	0,655
Ducato ( <b>front-avt</b> )	81=>	1430/1620	<b>07.797</b>	4359202	0,574
Ducato (passo lungo) ( <b>front-avt</b> )	81=>	2160/2355	<b>07.842</b>	5925334	0,830
Ducato (RHD mod.) LWB (only UK) ( <b>front-avt</b> )	81=>	2380/2630	<b>07.067</b>	5970619-474558	0,969
Ducato (RHD mod.) SWB (only UK) ( <b>front-avt</b> )	81=>	1650/1890	<b>07.478</b>	474557-5966282	0,697
Ducato	81=>	715+715/ 2590	<b>07.796</b>	4450938	0,554
Ducato (passo medio) ( <b>front-avt</b> )	90=>94	2360/2550	<b>07.0618</b>	7660110	•
Ducato (RHD mod.) (only UK) ( <b>front-avt</b> )	94=>	900/1140	<b>07.1164</b>	1310462080	•
Ducato all ( <b>front-avt</b> )	94=>	770/1060	<b>07.0171</b>	1308638080-4745G2	0,468
Ducato all	94=>	810+810/ 3025	<b>07.0172</b>	4745G3-1307963080	0,748
Ducato all (Camping Car)	94=>	810+810/ 3040	<b>07.0830</b>	4745G7-1314983080	0,699
Ducato all (ch. 16158428-)	=>01	865+865/ 2806	<b>07.1363</b>	4745V2-1330058080	0,748
Ducato all ( <b>front-avt</b> )	01=>	761/1078	<b>07.1110</b>	1336889080-4745V6	0,484
Ducato restyling (drum brake)	01=>	875+875/ 2825	<b>07.1365</b>	1337440080	0,693
Ducato restyling (disc brake)	01=>	890+890/ 2715	<b>07.1366</b>	1329845080-1339676080 1339394080	0,838
Ducato all (Camping Car) (ch. 16158428-)	=>02	875+875/ 2825	<b>07.1364</b>	1330066080-4745V3	•
Ducato 4x4 (only UK) ( <b>front-avt</b> )	02=>	843/1170	<b>07.1343</b>	4745V7-1337455080	•
Ducato II all ( <b>front-avt</b> )	02=>	645/1463	<b>07.1345</b>	4745W6-1338683080	0,404
Ducato II all (disc brake) (LH/RH-SX/DX)	02=>	782/955	<b>07.1346</b>	4745W7-1338691080	0,376
Ducato III all (exc.maxi) (LH/RH-SX/DX)	06=>	1075/1385	<b>07.1883</b>	1341031080-474617	0,486
Ducato III all maxi (LH/RH-SX/DX)	06=>	1170/1480	<b>07.1925</b>	1348980080-474618	0,459
Ducato III all passo 3450 ( <b>front-avt</b> )	06=>	2035/2295	<b>07.1926</b>	1350313080-474627	0,895
New Ducato cab.-cab. Fap mod. ( <b>front-avt</b> )	06=>	2390/2645	<b>07.1676</b>	474629-474650-1350314080 1359247080	1,005
New Ducato 2006/2006 Fap mod. ( <b>front-avt</b> )	06=>	1650/1910	<b>07.1677</b>	474647-4745Z9-1341023080 1359245080	0,763
New Ducato 2006/2006 Fap mod. long body ( <b>front-avt</b> )	06=>	2650/2910	<b>07.1678</b>	474649-474628-1350315080 1359248080	1,399
Talento ( <b>front-avt</b> )	88=>	1555/1685	<b>07.008</b>	7641373	0,689
Talento	88=>	1015+1025/ 2285	<b>07.009</b>	7641374	0,854

**COMANDI FLESSIBILI FUNE FRENO A MANO - BRAKE CABLES - CABLES DE FREIN  
BREMSEILE - CABLES DE FRENO - CABOS DE TRAVAO  
LINKI HAMULCA - BRZDOVÁ LANKA - ТРОСЫ РУЧНОГО ТОРМОЗА**





				OEM REF.	
<b>FIAT IVECO - Commercial Vehicle</b>					
Daily/Grinta 28-30-32-35-40.8-30.9-35.9-35.10 35.10 T-45.10-49.10-"A"-Bus (front-avt)	=>85	1050/1240	<b>7.654</b>	93801422	•
Daily/Grinta 28-30-32-35-30.9-35.9-35.10 35.10 T-45.10-49.10-"B"-Bus (front-avt)	=>85	1450/1640	<b>7.655</b>	93801912	1,202
Daily/Grinta 28-30-32-35-30.9-35.9-40.8 35.10-35.10 T-45.10 49.10-"C" (front-avt)	=>85	1850/2040	<b>7.656</b>	93801943	1,465
Daily/Grinta 30-35-40.8-30.9-35.9-35.10 45.10-49.10-"A"-Bus (front-avt)	85=>	405/1200	<b>7.699</b>	93807299	0,454
Daily/Grinta 30-35-40.8-30.9-35.9-35.10 45.10-49.10-"B"-Bus (front-avt)	85=>	405/1600	<b>7.700</b>	93807295	0,537
Daily/Grinta 30/35/40.8-30.9-35.9-35.10 45.10-49.10-"C" (front-avt)	85=>	405/1995	<b>7.701</b>	93807304	0,591
Daily/Grinta 28-30-32-35.8-30.9-35.10-45.10 49.10 (single wheels)-Bus	85=>	1090+1090/ 2700	<b>7.810</b>	93801489	0,800
Daily/Grinta (double wheels)	85=>	955+955/ 2395	<b>07.657</b>	93801482	0,730
Daily/Grinta T 49.10	=>89	960+960/ 2500	<b>07.152</b>	7166079	0,775
Daily 30/35/40.8-30.9-35.9-35.10- 35.10 T-45.10 49.10-Bus	90=>	990+990/ 2500	<b>7.987</b>	7169714	0,750
Daily 45.10 T D	90=>	980+980/ 2480	<b>07.976</b>	7169752	0,771
Daily 30.8-35.10 (single wheels)	90=>	1060+1060/ 2660	<b>07.261</b>	7169715	0,797
Daily (New) 35.8-35.10-35.12-49.12 Passo 3300 (front-avt)	96=>	890/1645	<b>07.940</b>	93812315	0,878
Daily (New) 35.8-35.10-35.12-49.12 Passo 3600 (front-avt)	96=>	880/1930	<b>07.938</b>	93812316	0,915
Daily 35.10-45.10-49.12	=>96	960+960/ 2730	<b>07.1166</b>	99443478	0,750
Daily (New) 35.8-35.10-35.12	96=>	980+980/ 2670	<b>07.1167</b>	99434589	0,750
Daily T 59.12	96=>	1010+1010/ 2915	<b>07.1509</b>	93812499	1,834
Daily (New) 35.8-35.10-35.12-49.12 Passo 2800 (front-avt)	96=>	775/1135	<b>07.983</b>	93812314	0,753
Daily Turbo 59.12-Passo 3310 (front-avt)	96=>	920/1520	<b>07.1169</b>	93812534	0,867
Daily (New) T 59.12-Passo 3600 (front-avt)	96=>	920/1810	<b>07.1170</b>	93812535	0,903
Daily (New) T 59.12-Passo 3950 (front-avt)	96=>	1340/2160	<b>07.1171</b>	93812536	1,238
Daily (New) T 59.12-Passo 4180 (front-avt)	96=>	1560/2360	<b>07.1172</b>	93812537	1,412
Daily Restayling 30.8-35.8-40.8-45.10-19.10 (front-avt)		410/2340	<b>07.1168</b>	93808122	0,631
Daily (New) (front-avt)			<b>07.009/1</b>	99461607	0,783
Daily (New) 30-35-40.8-Passo 3600 (front-avt)		960/1850	<b>07.1173</b>	93815550	0,937
Daily (New) 30-35-40.8-Passo 3950 (front-avt)		1380/2200	<b>07.1174</b>	93821392	1,284
Daily (New) 30-35-40.8-35-45.10- Passo 3600 (front-avt)		940/1970	<b>07.1503</b>	93814579	0,934
Daily (New) 30-35-40.8-35-45.10- Passo 3600 (front-avt)		1330/2290	<b>07.1504</b>	93812317	1,209
Daily (New) 30-35-40.8-35-45.10- Passo 3950 (front-avt)		1360/2320	<b>07.1505</b>	93814580	1,228
Daily (New) 30-35-40.8-35-45.10- Passo 4180 (front-avt)		1540/2490	<b>07.1506</b>	93813236	1,366
Daily (New) 30-35.8-35.10-T Daily 30.10		1090+1090/ 2930	<b>07.1507</b>	99443477	0,830
Daily (New)-Turbo Daily-passo 2800 (front-avt)		735/101	<b>07.1508</b>	93821391	0,686
Daily 50 C13-50 C15 Bus (front-avt)	00=>	1315	<b>07.1165</b>	504003617	0,438
Daily 35S10-12-14-18 (single wheel)	00=>	960/1315	<b>07.1927</b>	500322988	0,398
Daily (II) 35C all	09/02=>	920/1266	<b>07.1666</b>	504347502	•
Daily (New) 35C10-C12-C15	06=>	865/1210	<b>07.1779</b>	504201378	0,387
Daily 29L 35.40 C12-C18-S14 (LH/RH-SX/DX)	06=>	980/1315	<b>07.1878</b>	504347504	•

**COMANDI FLESSIBILI FUNE FRENO A MANO - BRAKE CABLES - CABLES DE FREIN  
BREMSSSEILE - CABLES DE FRENO - CABOS DE TRAVAO  
LINKI HAMULCA - BRZDOVÁ LANKA - ТРОСЫ РУЧНОГО ТОРМОЗА**





				<b>OEM REF.</b>	
<b>FIAT IVECO - Commercial Vehicle</b>					
Daily 29L all (disc brake) (single wheel) (LH/RH-SX/DX)	06=>	1060/1414	<b>07.1929</b>	504201383-504347501	•

<b>FORD</b>					
Ka all (front-avt)	96=>	315	<b>07.0619</b>	1004542-1079068	0,355
Ka all	96=>	1400/1585+ 1450/1635	<b>07.0620</b>	1018642-1035693-1042338	1,297
Ka all	05/99=>	1387/1582+ 1445/1663	<b>07.0851</b>	1095564-1077296	1,254
Ka all	08/03=>	1397/1575+ 1477/1627	<b>07.1371</b>	1306275	1,340
Ka all (front-avt)	12/06=>10/08	333	<b>07.1780</b>	1527247	•
Ka all 1,3i	12/06=>10/08	1398/1575+ 1448/1627	<b>07.1838</b>	1479552-55512A603BA	0,613
Ka all 1,6i	12/06=>10/08	1398/1575+ 1448/1627	<b>07.1839</b>	1479551-55512A603AA	0,595
Ka II 1,2i (RH-DX)	11/08=>	1182/1430	<b>07.1836</b>	1541338-9S512A603AA	0,483
Ka II 1,2i (LH-SX)	11/08=>	1155/1402	<b>07.1837</b>	1541339-9S512A603BA	0,476
Fiesta all (front-avt)	76=>	635	<b>07.845</b>	6054814-6094081	0,053
Fiesta all (RH-DX)	76=>	500	<b>07.616</b>	6056818-6040602	0,061
Fiesta all (LH-SX)	76=>	1310	<b>07.710</b>	6056822-6040610	0,095
Fiesta all	83=>	1145+1150/ 2745	<b>07.953</b>	6139621	0,947
Fiesta all (front-avt)	83=>	170	<b>07.952</b>	1619118-6094082	0,028
Fiesta all	86=>	1130+1150/ 2775	<b>07.010</b>	1627591-6163735-6169520 6148322-6159054	1,045
Fiesta all	88=>	1380+1425/ 3285	<b>07.069</b>	1659647-1659671	1,224
Fiesta all (front-avt)	89=>	150	<b>07.071</b>	1656491-6502746	0,028
Fiesta all	90=>91	1344+1400/ 3242	<b>07.0174</b>	6658751	1,314
Fiesta all	91=>93	1680+1745/ 3930	<b>07.0175</b>	6723389	1,513
Fiesta all	94=>	1387+1395/ 3255	<b>07.0176</b>	7127225	1,335
Fiesta all (front-avt)	96=>	315	<b>07.0619</b>	1004542-1079068	0,355
Fiesta all	96=>	1400/1585+ 1450/1635	<b>07.0620</b>	1018642-1035693-1042338	1,297
Fiesta all	05/99=>	1387/1582+ 1445/1663	<b>07.0851</b>	1095564-1077296	1,254
Fiesta all (front-avt)	02=>	300	<b>07.1175</b>	1205735	0,041
Fiesta all	02=>	1116/1305+ 1257/1445	<b>07.1176</b>	1211024	1,103
Fiesta all (drum brake)	02=>	175	<b>07.1177</b>	1094178-1226733-1220462 1253162-1209852-1232018 1064280-98AG2A635AF	0,028
Fiesta St 150	02=>	1440/1600+ 1580/1750	<b>07.1369</b>	1359528	1,359
Fiesta all (front-avt)	09=>	408	<b>07.1869</b>	1534504-8V512853AA	•
Fiesta all	09=>	1165/1325/+ 1195/1360	<b>07.1894</b>	1544245-8V512A603AJ	•
Fiesta all small (drum brake)	09=>	160	<b>07.1895</b>	1514201-8V512A635AB	•
Fusion all (front-avt)	02=>	300	<b>07.1175</b>	1205735	0,041
Fusion all	02=>	1116/1305+ 1257/1445	<b>07.1176</b>	1211024	1,103
Fusion all (drum brake)	02=>	175	<b>07.1177</b>	1094178-1226733-1220462 1253162-1209852-1232018 1064280-98AG2A635AF	0,028
Puma all (front-avt)	96=>	315	<b>07.0619</b>	1004542-1079068	0,355





**COMANDI FLESSIBILI FUNE FRENO A MANO - BRAKE CABLES - CABLES DE FREIN  
BREMSSEILE - CABLES DE FRENO - CABOS DE TRAVAO  
LINKI HAMULCA - BRZDOVÁ LANKA - ТРОСЫ РУЧНОГО ТОРМОЗА**

				OEM REF.	
<b>FORD</b>					
Puma all	96=>	1400/1585+ 1450/1635	<b>07.0620</b>	1018642-1035693-1042338	1,297
Puma all	05/99=>	1387/1582+ 1445/1663	<b>07.0851</b>	1095564-1077296	1,254
Escort MKI all	=>12/74	800/1675	<b>07.385</b>	1464467	0,406
Escort MKII all	75=>80	880/1830	<b>07.618</b>	6033183-75AB2853AB	0,492
Escort/Orion all (front-avt)	80=>	175	<b>07.952</b>	6094082-1619118	0,028
Escort/Orion (LH-SX)	80=>	1315/1605	<b>07.847</b>	6092734-6130715	0,550
Escort/Orion (RH-DX)	80=>	1200/1350	<b>07.954</b>	6081825-6130714-6137663	0,500
Escort Cabrio/Orion 1,6ie (LH-SX)	80=>84	1285/1605	<b>07.482</b>	6131134	0,574
Escort Cabrio/Orion 1,6ie (RH-DX)	80=>84	1160/1350	<b>07.483</b>	6131133	0,475
Escort XR3i (LH-SX)	84=>	1290/1605	<b>07.480</b>	1613311-83AB2A823AA	0,565
Escort XR3i (RH-DX)	84=>	1165/1355	<b>07.481</b>	1613310-83AB2A604AA	0,498
Escort/Orion (only UK) (LH-SX)	04/84=>08/84	1250/1585	<b>07.0177</b>	1640551-83AB2A823CF 6139443	0,572
Escort/Orion (LH-SX)	04/84=>08/84	1275/1570	<b>07.0435</b>	6139442	0,581
Escort/Orion 1,1-1,3	84=>85	1180+1300/ 2960	<b>07.426</b>	6158711-6148022	0,998
Escort/Orion 1,6	84=>85	1128+1264/ 2984	<b>07.429</b>	6148023	1,169
Escort/Orion (only UK) (RH-DX)	84=>85	1145/1315	<b>07.772</b>	6139440-1637507	0,577
Escort/Orion (only UK) (LH-SX)	84=>85	1265/1580	<b>07.773</b>	6148025-1640550	0,539
Escort/Orion 1,6ie	85=>86	1170+1300/ 2980	<b>07.054</b>	6141434	1,111
Escort/Orion 1,1-1,3-1,6-D	85=>86	1140+1275/ 2942	<b>07.208</b>	6141433	1,070
Escort/Orion 1,6ie	86=>	1170+1280/ 2980	<b>07.211</b>	6161953-6168201	1,026
Escort/Orion 1,4-1,6-D	86=>	1185+1290/ 2970	<b>07.209</b>	6161952-6168200	0,998
Escort-Orion all (front-avt)	89=>	150	<b>07.071</b>	1656491-6502746	0,028
Escort/Orion all	09/90=>05/91	1380/1630+ 1315/1600	<b>07.431</b>	1664644-1664872	0,614
Escort Rs	91=>	1270+1390/ 3150	<b>07.0432</b>	6676125	1,065
Escort/Orion all	06/91=>92	1311+1400/ 3275	<b>07.433</b>	6676122-6676123-6912221 6920298-6637334	1,327
Escort Cosworth	92=>	930+1030/ 3220	<b>07.0433</b>	7009327	0,770
Escort/Orion 1,4-1,6-1,8	92=>93	1320+1380/ 3330	<b>07.0434</b>	1664703	1,249
Escort 1,3-1,4-1,6-1,8-1,8D-2,0i (exc.ABS)	93=>95	1380+1460/ 3400	<b>07.0857</b>	6785736	1,314
Escort Van	93=>95	1380+1460/ 3400	<b>07.0857</b>	6785736	1,314
Escort all (front-avt)	95=>	280	<b>07.0622</b>	1027516-1064455	0,034
Escort all 4WD	01/95=>	1641/1641+ 1465/1465	<b>07.0625</b>	7402918-1036208	1,259
Escort/Orion all	01/95=>05/95	1510/1705+ 1475/1670	<b>07.0623</b>	7402912-1010349-1036199	1,337
Escort all (front-avt)	95=>11/95	280	<b>07.1511</b>	1002209	0,340
Escort 1,8 zetec H/power-2,0 16v	06/96=>	1437/1604+ 1472/1640	<b>07.0624</b>	1036203	1,188
Escort all (only UK)	06/96=>	1724/1530+ 1460/1650	<b>07.0626</b>	7402911-1010346-1036201	1,306
Escort all 4WD (only UK)	06/96=>	1435/1580+ 1462/1640	<b>07.0627</b>	7402917-1036204	0,554
Escort 1,8 Zetec-2,0 16v (only UK)	06/96=>	1420/1582+ 1490/1655	<b>07.0628</b>	1010353-1036202	1,171
Focus all (front-avt)	99=>	326	<b>07.0852</b>	1076707-YS4Z2853AA	0,040
Focus all (drum brake)	99=>	1320/1480	<b>07.0853</b>	1069081-1088017-1097285 YS4Z2A603AB	1,109

**COMANDI FLESSIBILI FUNE FRENO A MANO - BRAKE CABLES - CABLES DE FREIN  
BREMSSEILE - CABLES DE FRENO - CABOS DE TRAVAO  
LINKI HAMULCA - BRZDOVÁ LANKA - ТРОСЫ РУЧНОГО ТОРМОЗА**

				OEM REF.	
<b>FORD</b>					
Focus all (disc brake)	99=>	1585/1765	<b>07.0854</b>	1069082-1101841-1087208 1088016-YS4ZZA603AB	1,407
Focus all (drum brake)	02=>	175	<b>07.1177</b>	1094178-1226733-1220462 1253162-1209852-1232018	0,028
Focus 2,0 RS-2,0 ST170	02=>04	1590/1770	<b>07.2007</b>	1306212	•
Focus all (drum brake) (LH/RH-SX/DX)	03=>	1320/1480	<b>07.1178</b>	1253158	1,210
Focus all (disc brake) (LH/RH-SX/DX)	03=>	1585/1765	<b>07.1179</b>	1253159-1143926	1,450
Focus II all ( <b>front-avt</b> )	05=>	337	<b>07.1372</b>	1321246-1371043	0,061
Focus II all (drum brake)	05=>	1340/1450+ 1390/1500	<b>07.1373</b>	1347494	•
Focus II all (drum brake)	05=>	230	<b>07.1375</b>	1340832	0,029
Focus II all (disc brake)	05=>	1700/1830+ 1740/1870	<b>07.1513</b>	1355127-1416442	1,354
Focus all ( <b>front-avt</b> )	01/05=>	332	<b>07.1563</b>	1228027	0,037
Focus II all (drum brake)	06=>	1388/1500+ 1338/1450	<b>07.1374</b>	1431308-1366384	1,000
Focus II all (disc brake)	07=>	1700/1810+ 1740/1855	<b>07.1585</b>	1323904-1490515	1,367
Focus II all ( <b>front-avt</b> )	06/07=>	341	<b>07.2006</b>	1676740-3M512853CC	•
Focus all (drum brake)	09/08=>	1340/1440+ 1388/1490	<b>07.1782</b>	1525803-3M512A603EB	•
Focus all ( <b>front-avt</b> )	10=>	306	<b>07.1949</b>	1711523-BV612853AA	0,060
Focus all (drum brake) small mod. mecc. brake (LH/RH-SX/DX)	10=>	230	<b>07.1950</b>	1688323-BV612A635AA	0,038
C-Max (exc.Ghia mod.) (disc brake)	06=>	1700/1830+ 1740/1870	<b>07.1513</b>	1355127-1416442	1,354
C-Max (exc.Ghia mod.) (disc brake)	07=>	1700/1810+ 1740/1855	<b>07.1585</b>	1323904-1490515	1,367
C-Max all (exc.Ghia mod.) ( <b>front-avt</b> )	06/08=>	341	<b>07.2006</b>	1676740-3M512853CC	•
S-Max all (RH-DX)	06=>	1854/2067	<b>07.1884</b>	1439906-6G912B700EE	0,724
S-Max all (LH-SX)	06=>	1860/2067	<b>07.1885</b>	1439905-6G912A635EE	0,726
S-Max all (LH-SX)	08/07=>08/10	1865/2080	<b>07.1896</b>	1468846-1510211 6G912A635EG	•
S-Max all (RH-DX)	08/07=>08/10	1860/2070	<b>07.1897</b>	1545340-1711718 6G912B700EG	•
Kuga all ( <b>front-avt</b> )	02/08=>	360	<b>07.1840</b>	1517528	0,064
Kuga all	02/08=>	1805/1935+ 1720/1850	<b>07.1781</b>	1540884	•
Capri all ( <b>front-avt</b> )	68=>72	1525	<b>07.853</b>	1451800	0,067
Capri MKII-III 1,3-1,6-2,0	74=>	700/2040	<b>07.707</b>	1561302	0,450
Capri MKII-III 2,8-3,0	74=>	920/1970	<b>07.706</b>	6034286	0,495
Taurus all	=>75	780+810/ 3180	<b>07.384</b>	1505906-1505907	0,788
Taurus all	75=>	785+860/ 3190	<b>07.708</b>	6041419	0,861
Cortina all	=>75	780+810/ 3180	<b>07.384</b>	1505906-1505907	0,788
Cortina all	75=>	785+860/ 3190	<b>07.708</b>	6041419	0,861
Sierra all (exc.6 cyl.)-4x4	82=>	880+990/ 3310	<b>07.955</b>	6120901	0,805
Sierra all SW-ABS mod./6 cyl.-SW	84=>	830/1700+ 1740/1870	<b>07.076</b>	1656793-Y85BB2A603AE 1644434	0,869

**COMANDI FLESSIBILI FUNE FRENO A MANO - BRAKE CABLES - CABLES DE FREIN  
BREMSSEILE - CABLES DE FRENO - CABOS DE TRAVAO  
LINKI HAMULCA - BRZDOVÁ LANKA - ТРОСЫ РУЧНОГО ТОРМОЗА**

				OEM REF.	
<b>FORD</b>					
Sierra	05/84=>89	880+985/ 3310	<b>07.849</b>	6139438-1644433	0,884
Sierra all (exc.6 cyl.)-4x4	89=>	880+985/ 3310	<b>07.075</b>	6194541-83BB2A603AH	0,917
Mondeo (drum brake) (LH/RH-SX/DX)	93=>	1330/1575	<b>07.0180</b>	6924890-6854704-F5RZ2A635A	0,598
Mondeo (disc brake) (LH/RH-SX/DX)	93=>	1215/1422	<b>07.0181</b>	6944442	0,530
Mondeo SW (drum brake) (LH/RH-SX/DX)	93=>	1330/1576	<b>07.0182</b>	6854704	0,592
Mondeo SW (disc brake) (LH/RH-SX/DX)	93=>	1340/1595	<b>07.0183</b>	6854705-7043631	0,565
Mondeo all (front-avt)	94=>	270	<b>07.0179</b>	6750550	0,092
Mondeo all (front-avt)	94=>	270	<b>07.1932</b>	7264793	0,090
Mondeo Saloon (drum brake) (LH/RH-SX/DX)	08/94=>	1330/1610	<b>07.0630</b>	1005567-1060213-1078043 1005568-1019239-1046070	0,549
Mondeo Saloon (disc brake)/Cougar (LH/RH-SX/DX)	08/94=>	1220/1465	<b>07.0631</b>	1038834-1050100-1060214 1093544-1103618	0,527
Mondeo SW (disc brake) (LH/RH-SX/DX)	08/96=>	1387/1647	<b>07.0855</b>	1005574-1019240-1040768 1048069	0,592
Mondeo all (4/5 doors) (LH/RH-SX/DX)	10/00=>	1532/1735	<b>07.1181</b>	1221742-1116840-1126842	0,559
Mondeo all SW (disc brake) (LH/RH-SX/DX)	10/00=>	1515/1720	<b>07.1182</b>	1220591-1116841-1117106	0,535
Mondeo/Cougar (front-avt)	00=>	305	<b>07.1562</b>	1221413-1349905	0,159
Mondeo all (LH-SX)	08/07=>08/10	1865/2080	<b>07.1896</b>	1468846-1510211 6G912A635EG	•
Mondeo all (RH-DX)	08/07=>08/10	1860/2070	<b>07.1897</b>	1545340-1711718 6G912B700EG	•
Contour/Mistique (drum brake) (USA mod.) (LH/RH-SX/DX)	94=>	1331/1575	<b>07.0180</b>	F5RZ2A635A	0,598
Granada all	78=>	780+800/ 3520	<b>07.800</b>	6057572	0,843
Granada all	85=>94	930+1030/ 3725	<b>07.0178</b>	6154286-6168203-6676649 6779443-6194542	0,878
Scorpio all	85=>94	930+1030/ 3725	<b>07.0178</b>	6154286-6168203-6676649 6779443-6194542	0,878
Scorpio all	95=>01/96	960+1028/ 3760	<b>07.0635</b>	7376434	0,806
Scorpio all	02/96=>	1008+1025/ 3800	<b>07.0636</b>	1026118	0,854
Galaxy all (interm.)	95=>	655	<b>07.0637</b>	1013482-7M0711472A	0,053
Galaxy all (LH/RH-SX/DX)	95=>	1130/1295	<b>07.0638</b>	7201624-95VW2A603AC	0,524
Galaxy WGR 1,9Tdi-2,3 16v-2,8 6v (disc brake) (LH/RH-SX/DX)	00=>03	1155/1320	<b>07.1783</b>	1109023-7M3609701 7M3609701D	•
Galaxy all (RH-DX)	06=>	1854/2067	<b>07.1884</b>	1439906-6G912B700EE	0,724
Galaxy all (LH-SX)	06=>	1860/2067	<b>07.1885</b>	1439905-6G912A635EE	0,726
Galaxy all (LH-SX)	08/07=>08/10	1865/2080	<b>07.1896</b>	1468846-1510211 6G912A635EG	•
Galaxy all (RH-DX)	08/07=>08/10	1860/2070	<b>07.1897</b>	1545340-1711718 6G912B700EG	•
Maverick 2,4-2,7 SWB (3 doors) (LH-SX)	02/93=>	1108/1324	<b>07.0680</b>	1954196-1961868-365310F001	0,497
Maverick 2,4-2,7 SWB (3 doors) (RH-DX)	02/93=>	1355/1410	<b>07.0681</b>	1954194-1961866-365300F001	0,502
Maverick 2,4-2,7 LWB (5 doors) (LH-SX)	02/93=>	1255/1470	<b>07.0682</b>	1954197-1961869-365310F601	0,529
Maverick 2,4-2,7 LWB (5 doors) (RH-DX)	02/93=>	1262/1478	<b>07.0683</b>	1954195-1961867-365300F601	0,528

**COMANDI FLESSIBILI FUNE FRENO A MANO - BRAKE CABLES - CABLES DE FREIN  
BREMSSEILE - CABLES DE FRENO - CABOS DE TRAVAO  
LINKI HAMULCA - BRZDOVÁ LANKA - ТРОСЫ РУЧНОГО ТОРМОЗА**







OEM REF.



**FORD - Commercial Vehicle**





Fiesta Partner	96=>	1700/1880+ 1750/1930	<b>07.0621</b>	1014214	1,285
Escort Van	80=>84	1285+1360/ 3160	<b>07.848</b>	6092885-6112878-1644435 6148024	1,120
Escort Van	84=>	1290+1375/ 3190	<b>07.080</b>	6092885-6148024	1,154
Escort Van	09/90=>	1385/1695+ 1465/1675	<b>07.072</b>	6600956	0,645
Escort Van	09/91=>	1390+1470/ 3300	<b>07.0643</b>	6676124	1,163
Escort Van	09/91=>95	1380+1460/ 3400	<b>07.0857</b>	6785736	1,314
Escort Van	01/95=>05/95	1505/1690+ 1549/1751	<b>07.0644</b>	1010351-1036229	1,219
Escort Van	06/95=>	1335/1720+ 1733/1527	<b>07.0645</b>	7402914-1036230-1010352	0,678
Transit 100-125 CWT	65=>	900x2+275/ 2660	<b>07.387</b>	1503957	0,749
Transit (twin wheels)	72=>	810+1040/ 2470	<b>07.854</b>	1503958	0,752
Transit all 100	76=>	1050x2+275/ 2875	<b>07.794</b>	6049290-77VB2A604CID	0,907
Transit 75-125 (only UK)	76=>	970+1230/ 2875	<b>07.850</b>	6049291-77VB2A604C2D	0,943
Transit all (twin wheels)	76=>	800+1030/ 2400	<b>07.799</b>	6048437-77VB2A604DIC	0,789
Transit 80-120	86=>	275+1070x2/ 2980	<b>07.213</b>	6166967	1,020
Transit 130-190A	86=>	275+820x2/ 2395	<b>07.214</b>	6166968-86VB2A604BE	0,884
Transit 100 L	86=>	275+1010x2/ 2870	<b>07.215</b>	6166969-86VB2A604CE	0,910
Transit (only UK)	86=>	190+950+960/ 2835	<b>07.0648</b>	6159020-86VB2A604AID	0,925
Transit all (single wheels)	91=>	235+980x2/ 2825	<b>07.0646</b>	6658706-92VR2853AD	1,139
Transit all (double wheels)	91=>	235+950x2/ 2730	<b>07.0647</b>	6658707-92VR2853CD	0,928
Transit ( <b>front-avt</b> )	04/00=>	486/910	<b>07.0858</b>	4041447	0,296
Transit FWD Van-Kombi	04/00=>	971/1263	<b>07.0859</b>	4095179	0,501
Transit ( <b>front-avt</b> )	04/00=>	632/1052	<b>07.1186</b>	4041448	0,339
Transit FWD Cab (RH-DX)	04/00=>	1018/1310	<b>07.0860</b>	4095178	0,478
Transit FWD Cab (LH-SX)	04/00=>	1355/1648	<b>07.0861</b>	4120677	0,580
Transit RWD Van-Kombi-Bus (RH-DX)	04/00=>	993/1282	<b>07.0862</b>	4041988-4331043	0,478
Transit RWD Van-Kombi-Bus (LH-SX)	04/00=>	1238/1528	<b>07.0863</b>	4122075-4331046	0,561
Transit RWD Cab (single wheel) (RH-DX)	04/00=>	1093/1386	<b>07.0864</b>	4041986	0,483
Transit RWD Cab (single wheel) (LH-SX)	04/00=>	1315/1608	<b>07.0865</b>	4331044	0,541
Transit RWD Cab (double wheels) (RH-DX)	04/00=>	967/1260	<b>07.0866</b>	4077635-4041987-4331042	0,451
Transit RWD Cab (double wheels) (LH-SX)	04/00=>	1290/1590	<b>07.1185</b>	4331045-4469261-4457993	0,574
Transit FWD Van-Kombi-Bus (LH-SX)	04/00=>	1250/1545	<b>07.1187</b>	4095181-4400344-4519422 4104571	0,604
Transit all SWB (interm.)	04/00=>	1083	<b>07.1586</b>	4041992-4060871	•
Transit all LWB (interm.)	04/00=>	1534	<b>07.1587</b>	4041993-4060872	0,120
Transit Connect all ( <b>front-avt</b> )	02=>	290	<b>07.1900</b>	5041276-2T142853AA	•
Transit Connect small mod.	03=>	1584+1584/ 1785	<b>07.1188</b>	4439339-4539856-4419300 2T142A603AG	1,520

**COMANDI FLESSIBILI FUNE FRENO A MANO - BRAKE CABLES - CABLES DE FREIN  
BREMSSEILE - CABLES DE FRENO - CABOS DE TRAVAO  
LINKI HAMULCA - BRZDOVÁ LANKA - ТРОСЫ РУЧНОГО ТОРМОЗА**





				OEM REF.	
<b>FORD - Commercial Vehicle</b>					
Transit Connect small mod. ABS	03=>	1771+1771/ 1980	<b>07.1189</b>	4439345-4407359-4367116 4388054-4419302-4480912	1,545
Transit Connect large mod.	03=>	1774/1976	<b>07.1190</b>	4439343-4539858-4419301 2T142A603BG	1,560
Transit Connect large mod. ABS	03=>	1865+1865/ 1998	<b>07.1191</b>	4439347-4480913-4105357 2T142A603DG-4367117-4388055 4407360-4419303-4539860	1,845
Transit FWD Van-Kombi-Bus (RH-DX)	03=>	990/1283	<b>07.1192</b>	4519421	0,477
Transit all RWD Cab. (double wheels) (RH-DX)	04/03=>	1040/1332	<b>07.1378</b>	4457990-4654291-YC152A635BJ	•
Transit FWD Cab. (RH-DX)	03=>	1050/1350	<b>07.1512</b>	4519419	•
Transit RWD Cab. (single wheels) (disc brake) (RH-DX)	04/06=>	1111/1317	<b>07.1866</b>	1388277-6C112A635CB	•
Transit RWD Cab. (single wheels) (disc brake) (LH-SX)	04/06=>	1398/1602	<b>07.1867</b>	1388281-1441581 6C112AB09CC	•
Transit Bus (front-avt)	04/06=>	1677/1919	<b>07.1898</b>	5032100-7C1V2853DB	•
Transit all (exc.Bus) (front-avt)	04/06=>	1304/1284	<b>07.1899</b>	6C112853BD	•
Transit FWD Van-Kombi-Bus (RH-DX)	07=>	985/1280	<b>07.2008</b>	1494893-1C152A635CE	•
Transit FWD Cab. (drum brake) (RH-DX)	04/07=>	1058/1354	<b>07.1784</b>	1494890-1C152A635AE	•
Transit FWD Cab. (drum brake) (LH-SX)	04/07=>	1353/1650	<b>07.1785</b>	1494895-1C152A809AF	•
Transit RWD Cab. 2,3 all (RH-DX)	10/07=>	805/1028	<b>07.1857</b>	1488312-1518017-8C1V2A635BB	•
Transit RWD Cab. 2,3 all (LH-SX)	10/07=>	1115/1337	<b>07.1858</b>	1488314-1518020-8C1V2A809BB	•
Transit RWD Van 460E (RH-DX)	10/07=>	769/994	<b>07.1859</b>	1488313-1552043 8C1V2A635DC	•
Transit RWD Van 460E (LH-SX)	10/07=>	1120/1343	<b>07.1860</b>	1488315-1518021 8C1V2A809DB	•
Transit RWD Van-Kombi-Bus S350-430 (double wheels) (disc brake) (RH-DX)	04/06=>06/08	1033/1235	<b>07.1861</b>	1388278-6C112A635DB	0,876
Transit RWD Van-Kombi-Bus (single wheels) (disc brake) (RH-DX)	04/06=>06/08	1066/1266	<b>07.1862</b>	1388275	•
Transit RWD Van-Kombi-Bus S350-430 (double wheels) (disc brake) (RH-DX)	06/08=>	1066/1266	<b>07.1862</b>	1552037-6C112A809DB	•
Transit RWD Van-Kombi-Bus S350-430 (double wheels) (disc brake) (LH-SX)	04/06=>06/08	1308/1506	<b>07.1863</b>	1388282-6C112A809DB	•
Transit RWD Cab. 300-330-350-430 (double wheels) (disc brake) (RH-DX)	04/06=>07/09	1070/1270	<b>07.1864</b>	1388276-6C112A635BB	•
Transit RWD Cab. 300-330-350-430 (double wheels) (disc brake) (LH-SX)	04/06=>07/09	1335/1533	<b>07.1865</b>	1388280-1441580-6C112A809BC	•
Transit RWD Van-Kombi-Bus (single wheels) (disc brake) (LH-SX)	04/06=>06/08	1332/1532	<b>07.1868</b>	1388279-6C112A809AB	•
Transit Connect 200-220D-1,8 Tdi-1,8 Tdci-1,8 large ABS	07=>	1860/1984+ 1860/1984	<b>07.1901</b>	5030151-5135370-7T162A603DD	•
Transit Connect 200-220D-1,8 Tdi-1,8 Tdci-1,8 large no ABS	08=>		<b>07.1902</b>	1475243-1516244-2T162A603BB	•
Transit Connect 200-220D-1,8 Tdi-1,8 Tdci-1,8 small ABS	08=>	1690/1818+ 1694/1818	<b>07.1903</b>	5030150-5135369-7T162A603CD	•
Transit Connect 200-220D-1,8 Tdi-1,8 Tdci-1,8 small ABS	08=>	1588/1784+ 1588/1784	<b>07.1904</b>	1516240-5030119-5135368 7T162A603AD	•

<b>HONDA</b>					
Concerto 1,4-1,5 (drum brake) (RH-DX)	90=>	1350/1530	<b>07.0185</b>	47510SK3E12-47510SK3Z50	0,550
Concerto 1,4-1,5 (drum brake) (LH-SX)	90=>	1330/1505	<b>07.0186</b>	47560SK3E12-47560SK3Z50	0,595
Concerto 1,6 ABS (disc brake) (RH-DX)	90=>	1480/1680	<b>07.0187</b>	47510SK3E01-47510SK3Z60	0,671
Concerto 1,6 ABS (disc brake) (LH-SX)	90=>	1455/1655	<b>07.0188</b>	47560SK3E01-47560SK3Z60	0,675
Civic (front-avt)	73=>78	1275	<b>07.0007</b>	47510657921	•
Civic (front-avt)	78=>	1340	<b>07.0008</b>	47510659020	0,089

**COMANDI FLESSIBILI FUNE FRENO A MANO - BRAKE CABLES - CABLES DE FREIN  
BREMSSEILE - CABLES DE FRENO - CABOS DE TRAVAO  
LINKI HAMULCA - BRZDOVÁ LANKA - ТРОСЫ РУЧНОГО ТОРМОЗА**





				OEM REF.	
<b>HONDA</b>					
Civic (LH-SX)	84=>	1240/1425	<b>07.0009</b>	47560SB3033-47560SB3073	0,687
Civic (RH-DX)	84=>	1240/1425	<b>07.0010</b>	47510SB3033-47510SB3073	0,681
Civic all (4 doors) (RH-DX)	84=>86	1301/1495	<b>07.0298</b>	47510SB4063	0,651
Civic all (4 doors) (LH-SX)	84=>86	1301/1495	<b>07.0299</b>	47560SB4063	0,676
Civic all (drum brake) (LH-SX)	87=>91	1350/1515	<b>07.0189</b>	47560SH3013	0,583
Civic all (drum brake) (RH-DX)	87=>91	1350/1515	<b>07.0190</b>	47510SH3013	0,589
Civic all (disc brake) (LH-SX)	87=>91	1480/1655	<b>07.0191</b>	47560SH7013-47560SH3932	0,636
Civic all (disc brake) (RH-DX)	87=>91	1464/1657	<b>07.0192</b>	47510SH7013-47510SH3932	0,598
Civic all (drum brake) (LH-SX)	92=>	1305/1480	<b>07.0193</b>	47560SR3N01	0,614
Civic all (drum brake) (RH-DX)	92=>	1315/1480	<b>07.0194</b>	47510SR3N01	0,661
Civic all (disc brake) (LH-SX)	92=>	1445/1615	<b>07.0195</b>	47560SR3931-47560SR3933	0,731
Civic all (disc brake) (RH-DX)	92=>	1440/1620	<b>07.0196</b>	47510SR3931-47510SR3933	0,731
Civic all (RH-DX)	95=>98	1358/1542	<b>07.1691</b>	47510SR4A01	0,697
Civic all (LH-SX)	95=>98	1352/1535	<b>07.1692</b>	47560SR4A01	0,670
Civic 1,4 (5 doors) (LH-SX)		1450/1630	<b>07.1930</b>	47560ST3E13	•
Civic 1,4 (5 doors) (RH-DX)		1470/1655	<b>07.1931</b>	47510ST3E11	•
<b>Accord 1,6-1,8 (front-avt)</b>	77=>78	1625/1945	<b>07.0011</b>	47510671003	0,660
Accord (LH-SX)	79=>81	695	<b>07.0012</b>	47521671670	0,041
Accord (RH-DX)	79=>81	595	<b>07.0013</b>	47520671671	0,040
Accord all (drum brake) (LH-SX)	82=>85	1340/1535	<b>07.0014</b>	47560SA5023	•
Accord all (drum brake) (RH-DX)	82=>85	1340/1535	<b>07.0015</b>	47510SA5023	0,611
Accord all (drum brake) (LH-SX)	85=>89	1525/1705	<b>07.0208</b>	47560SE0010-47560SE0020	0,696
Accord all (drum brake) (RH-DX)	85=>89	1525/1705	<b>07.0209</b>	47510SE0010-47510SE0020	0,642
Accord all (drum brake) (LH-SX)	90=>	1575/1790	<b>07.0211</b>	47560SM4A03	0,752
Accord all (drum brake) (RH-DX)	90=>	1585/1800	<b>07.0212</b>	47510SM4A03	0,714
Accord all (disc brake) (LH-SX)	82=>85	1430/1615	<b>07.0213</b>	47560SA5952-47560SA5955	0,697
Accord all (disc brake) (RH-DX)	82=>85	1425/1615	<b>07.0214</b>	47510SA5952-47510SA5955	0,707
Accord all (disc brake) (LH-SX)	85=>89	1600/1785	<b>07.0215</b>	47560SE0932-47560SE0933	•
Accord all (disc brake) (RH-DX)	85=>89	1600/1805	<b>07.0216</b>	47510SE0932-47510SE0933	0,744
Accord all (disc brake) (LH-SX)	89=>92	1640/1855	<b>07.0217</b>	47560SM4955-47560SM5952	0,766
Accord all (disc brake) (RH-DX)	89=>92	1635/1855	<b>07.0218</b>	47510SM4955-47510SM5952	•
Accord all (disc brake) (LH-SX)	09/92=>	1640/1870	<b>07.0219</b>	47560SN7953	0,784
Accord all (disc brake) (RH-DX)	09/92=>	1640/1870	<b>07.0220</b>	47510SN7953	0,782
Accord all (disc brake) (RH-DX)	98=>03	1510/1736	<b>07.1693</b>	47510S1AE04	0,670
Accord all (disc brake) (LH-SX)	98=>03	1495/1721	<b>07.1694</b>	47560S1AE04	•
Acura Integra (LH-SX)	=>99	1480/1660	<b>07.0873</b>	47560SR4934	0,735
Acura Integra (RH-DX)	=>99	1485/1665	<b>07.1510</b>	47510SR4933	0,771
<b>Prelude (front-avt)</b>	79=>	535	<b>07.0016</b>	47520692670	0,039
<b>Prelude (front-avt)</b>	80=>	550	<b>07.0017</b>	47520692671	•
Prelude (LH/RH-SX/DX)	79=>81	1540/1855	<b>07.0018</b>	47510692003	0,636
Prelude (LH-SX)	82=>	1295/1470	<b>07.0019</b>	47560SB0672	0,564
Prelude (RH-DX)	82=>	1295/1470	<b>07.0020</b>	47510SB0672	0,576
Prelude AB+BA2 1,8 (LH-SX)	84=>88	1365/1530	<b>07.0221</b>	47560SB0053	0,688
Prelude AB+BA2 1,8 (RH-DX)	84=>88	1365/1530	<b>07.0222</b>	47510SB0053	0,672
Prelude 2,0 16v (ch. 0C002665-) (LH-SX)	84=>88	1365/1540	<b>07.0223</b>	47560SF0013	0,674
Prelude 2,0 16v (ch. 0C002665-) (RH-DX)	84=>88	1370/1540	<b>07.0224</b>	47510SF0013	0,671
Prelude BA4 2,0 (LH-SX)	88=>	1650/1810	<b>07.0225</b>	47560SF1003	0,743
Prelude BA4 2,0 (RH-DX)	88=>	1635/1810	<b>07.0226</b>	47510SF1003	0,617

**COMANDI FLESSIBILI FUNE FRENO A MANO - BRAKE CABLES - CABLES DE FREIN  
BREMSEILE - CABLES DE FRENO - CABOS DE TRAVAO  
LINKI HAMULCA - BRZDOVÁ LANKA - ТРОСЫ РУЧНОГО ТОРМОЗА**

				OEM REF.	
<b>HONDA</b>					
HR-V (3 doors) (RH-DX)	98=>06	1167/1425	<b>07.1786</b>	47510S2H013	•
HR-V (3 doors) (LH-SX)	98=>06	1225/1480	<b>07.1787</b>	47560S2H013	•
HR-V (5 doors) (RH-DX)	98=>06		<b>07.1788</b>	47510S4N013	•
HR-V (5 doors) (LH-SX)	98=>06		<b>07.1789</b>	47560S4N013	•

<b>HYUNDAI</b>					
Pony 1,2-1,4 (LH/RH-SX/DX)	78=>	885/1260	<b>07.217</b>	5976011000	0,796
Pony 1,2-1,4 (LH-SX)	78=>	910/1265	<b>07.0021</b>	5977011000	0,411
Pony/Excel (LH/RH-SX/DX)	=>09/88	1250/1445	<b>07.0227</b>	5976021000	0,534
Pony/Excel/Scoupe (LH/RH-SX/DX)	88=>90	1215/1455	<b>07.0228</b>	5976021320-5977021320	0,540
Pony/Excel/Scoupe (LH-SX)	91=>93	1320/1505	<b>07.0230</b>	5976028000	0,629
Pony/Excel/Scoupe (RH-DX)	91=>93	1330/1515	<b>07.0231</b>	5977028000	0,633
Accent all (LH-SX)	=>10/95	1335/1505	<b>07.0651</b>	5976022000	0,617
Accent all (RH-DX)	=>10/95	1332/1505	<b>07.0652</b>	5977022000	0,609
Accent all (LH-SX)	11/95=>	1320/1485	<b>07.0653</b>	5976022100-5976022110 5976025000	0,639
Accent all (RH-DX)	11/95=>	1318/1485	<b>07.0654</b>	5977022100-5977022110 5977025000	0,609
Accent all Hatchback (LH-SX)	02=>	1295/1493	<b>07.1701</b>	5976025200	0,616
Accent all Hatchback (RH-DX)	02=>	1295/1493	<b>07.1702</b>	5977025200	•
Coupé all (drum brake) (LH-SX)	94=>	1305/1520	<b>07.0656</b>	5976027001	0,649
Coupé all (drum brake) (RH-DX)	94=>	1295/1512	<b>07.0657</b>	5977027001	0,660
Coupé all (disc brake) (LH-SX)	94=>	1199/1377	<b>07.0658</b>	5976027300-5976027301	0,623
Coupé all (disc brake) (RH-DX)	94=>	1192/1370	<b>07.0659</b>	5977027300-5977027301	0,617
Coupé all (drum brake) (LH-SX)	02=>	1281/1430	<b>07.1707</b>	597602C300	•
Coupé all (drum brake) (RH-DX)	02=>	1297/1430	<b>07.1708</b>	597702C300	0,678
Coupé all (disc brake) (LH-SX)	02=>	1280/1425	<b>07.1709</b>	597602C320	0,637
Coupé all (disc brake) (RH-DX)	02=>	1280/1430	<b>07.1710</b>	597702C320	0,648
Sonata (disc brake) (LH-SX)	95=>	1643/1829	<b>07.0879</b>	5976034102	0,821
Sonata (disc brake) (RH-DX)	95=>	1643/1827	<b>07.0880</b>	5977034102	0,864
Stellar	87=>	690+740/ 2910	<b>07.0024</b>	5975031200-5975032300	0,796
Atos 1,0 all (LH-SX)	98=>	1318/1504	<b>07.0874</b>	5976002010-5976002020	0,632
Atos 1,0 (-ch.980901) (LH/RH-SX/DX)	98=>	1335/1522	<b>07.0875</b>	5977002010-5977002020	0,609
Elantra 1,6-2,0 w/ABS (LH-SX)	06/00=>	1416/1601	<b>07.0877</b>	597602D310	0,702
Elantra 1,6-2,0 w/ABS (RH-DX)	06/00=>	1402/1587	<b>07.0878</b>	597702D310	0,698
Getz all (3 doors) (LH-SX)	03=>	1341/1584	<b>07.1695</b>	597601C800	0,748
Getz all (3 doors) (RH-DX)	03=>	1350/1593	<b>07.1696</b>	597701C800	•
Getz all (drum brake) (LH-SX)	03=>	1363/1610	<b>07.1697</b>	597601C300	0,753
Getz all (drum brake) (RH-DX)	03=>	1373/1620	<b>07.1698</b>	597701C300	0,759
Getz all (disc brake) (LH-SX)	03=>	1362/1590	<b>07.1699</b>	597601C000	0,729
Getz all (disc brake) (RH-DX)	03=>	1375/1600	<b>07.1700</b>	597701C000	0,749
I-30 all (LH-SX)	09/07=>	1518/1715	<b>07.1870</b>	597602L300-597602H300	0,773
I-30 all (RH-DX)	09/07=>	1518/1715	<b>07.1871</b>	597702L300-597702H300	0,773

**COMANDI FLESSIBILI FUNE FRENO A MANO - BRAKE CABLES - CABLES DE FREIN  
BREMSEILE - CABLES DE FRENO - CABOS DE TRAVAO  
LINKI HAMULCA - BRZDOVÁ LANKA - ТРОСЫ РУЧНОГО ТОРМОЗА**





				OEM REF.	
<b>HYUNDAI</b>					
Lantra all (drum brake) (LH-SX)	96=>	1362/1578	<b>07.1703</b>	5976029001	0,656
Lantra all (drum brake) (RH-DX)	96=>	1357/1571	<b>07.1704</b>	5977029001	0,666
Lantra all (disc brake) (LH-SX)	96=>	1260/1436	<b>07.1705</b>	5976029301	0,611
Lantra all (disc brake) (RH-DX)	96=>	1250/1428	<b>07.1706</b>	5977029301	0,606
Matrix all (LH-SX)	01=>	1405/1650	<b>07.1711</b>	5976017010	0,703
Matrix all (RH-DX)	01=>	1475/1718	<b>07.1712</b>	5977017010	0,742
Santafé (LH-SX)	01=>	1526/1741	<b>07.1713</b>	5991226150	0,771
Santafé (RH-DX)	01=>	1571/1776	<b>07.1714</b>	5991326150	0,761

<b>INNOCENTI</b>					
Mini Minor (LH/RH-SX/DX)	=>76	1555	<b>07.270</b>	38806105	0,129
Mini T (LH/RH-SX/DX)	=>76	1685	<b>07.271</b>	38802106	0,127
Mini 90-120-De Tomaso (LH/RH-SX/DX)	77=>	1440	<b>07.775</b>	53801105	0,116
Minitre 500-650-900 small (LH/RH-SX/DX)	85=>	1155/1530	<b>07.218</b>	558027107-558021107	0,429
Minitre 900 small (LH/RH-SX/DX)	86=>	1315/1700	<b>07.140</b>	558000108	0,492
Elba all	87=>91	1175+1175/ 2840	<b>07.148</b>	5969735	0,942
Elba all	92=>	1175+1175/ 2840	<b>07.762</b>	7522590	0,908

<b>ISUZU</b>					
Trooper KB 26 - C 190 Long WB (Centr.)	81=>83	615/905	<b>07.0025</b>	8942287450	0,328
Trooper 2600 mid/ch (LH-SX)	87=>89	1150/1395	<b>07.0439</b>	8942240300-8944238541	0,514
Trooper (RH-DX)	87=>89	1520/1710	<b>07.0443</b>	8942287450	0,507
Trooper 2800 D mid/ch (RH-DX)	87=>89	1265/1565	<b>07.1933</b>	8943240290	•
Trooper (LH-SX)	02/89=>91	1150/1375	<b>07.0438</b>	8970152980-8943667860	0,467
Trooper (RH-DX)	02/89=>91	1190/1415	<b>07.0442</b>	8970153010-8943667891	0,480
Trooper SWB (LH-SX)	92=>94	1260/1455	<b>07.0444</b>	8970181565/8970181566	0,571
Trooper SWB (RH-DX)	92=>94	1525/1715	<b>07.0445</b>	8970181545	0,654
Trooper LWB (LH-SX)	92=>94	1165/1360	<b>07.0440</b>	8970181554-8970181555	0,521
Trooper LWB (RH-DX)	92=>94	1470/1655	<b>07.0441</b>	8970181533	0,664
Pick-Up KB 20	=>76	1415+1415/ 4180	<b>07.0026</b>	5461511300-94026105	1,003
Pick-Up / Luv 2300 (LH-SX)	89=>		<b>07.1514</b>	8943667702-894366774	•
Pick-Up / Luv 2300 (RH-DX)	89=>		<b>07.1515</b>	8943667692	•
Faster Pick-Up TFR/TFS 2WD Long WB (RH-DX)	89=>	1445/1685	<b>07.0232</b>	8943667690	0,611
Faster Pick-Up TFR/TFS 2WD Long WB (LH-SX)	89=>	1365/1605	<b>07.0233</b>	8943667700	0,572
Faster Pick-up TFR all 2WD (interm.)	88=>06/99	1778	<b>07.1380</b>	522619-94367286	•
Faster Pick-up TFS all 4WD (interm.)	88=>06/99	1325/1380	<b>07.1381</b>	4303489-94367287	•
Faster Pick-up TFR all 2WD (RH-DX)	07/99=>	1700/1872	<b>07.1382</b>	522520-97174665	•
Faster Pick-up TFR all 2WD (LH-SX)	07/99=>	1640/1812	<b>07.1383</b>	522523-97217149	•
Faster Pick-up TFS all 4WD (RH-DX)	07/99=>	1700/1858	<b>07.1384</b>	522428-97111565	0,784
Faster Pick-up TFS all 4WD (LH-SX)	07/99=>	1630/1798	<b>07.1385</b>	522429-97111566	•

<b>KIA</b>					
Picanto all (RH-DX)	04=>	1306/1515	<b>07.1596</b>	597707310	•





**COMANDI FLESSIBILI FUNE FRENO A MANO - BRAKE CABLES - CABLES DE FREIN  
BREMSSEILE - CABLES DE FRENO - CABOS DE TRAVAO  
LINKI HAMULCA - BRZDOVÁ LANKA - ТРОСЫ РУЧНОГО ТОРМОЗА**

				OEM REF.	
<b>KIA</b>					
Picanto all (LH-SX)	04=>	1306/1515	<b>07.1597</b>	597607310	•
Picanto all (drum brake) (LH-SX)	04=>	1252/1488	<b>07.1905</b>	5976007010-5976007410	•
Picanto all (drum brake) (RH-DX)	04=>	1252/1488	<b>07.1913</b>	5977007010-5977007410	•
Picanto all (disc brake) (no ABS) (RH-DX)	04=>	1330/1520	<b>07.2001</b>	5977007300	•
Picanto all (disc brake) (no ABS) (LH-SX)	04=>	1330/1520	<b>07.2002</b>	5976007300	•
Rio all (RH-DX)	02=>	1390/1584	<b>07.1598</b>	OK30A44420H	0,557
Rio all (LH-SX)	02=>	1390/1584	<b>07.1599</b>	OK30A44410H	0,557
Sportage all (front-avt)	=>06	335	<b>07.1607</b>	OK01144150D-OK01144150G	0,108
Carnival all (front-avt)	99=>01	1447/1750	<b>07.1594</b>	OK55244150G	0,671
Carnival all MPV/VAN (front-avt)	02=>03	1450/1644	<b>07.1595</b>	OK56B44150	0,648
Carens all (disc brake) (LH-SX)	01=>	1405/1670	<b>07.1590</b>	OK2A244420D	0,683
Carens all (disc brake) (RH-DX)	01=>	1390/1658	<b>07.1591</b>	OK2A244410E-OK2A244410F	0,680
Carens all (drum brake) (LH-SX)	11/00=>	1363/1628	<b>07.1593</b>	OK2C044420	0,683
Carens all (drum brake) (RH-DX)	11/00=>	1357/1622	<b>07.1592</b>	OK2C044410	0,678
Carens all (front-avt)	04/02=>	265	<b>07.1767</b>	OK2FA44150	•
Shuma all (disc brake) (LH-SX)	01=>	1405/1670	<b>07.1590</b>	OK2A244420D	0,683
Shuma all (disc brake) (RH-DX)	01=>	1390/1658	<b>07.1591</b>	OK2A244410E-OK2A244410F	0,680
Shuma all (drum brake) (LH-SX)	11/00=>	1363/1628	<b>07.1593</b>	OK2C044420	0,683
Shuma all (drum brake) (RH-DX)	11/00=>	1357/1622	<b>07.1592</b>	OK2C044410	0,678
Shuma all (LH-SX)	94=>12/00	1365/1643	<b>07.1600</b>	OK2A144420E	0,727
Shuma all (RH-DX)	94=>12/00	1356/1633	<b>07.1601</b>	OK2A144410F	0,661
Cerato 1,6 Hatchback all (RH-DX)	03/04=>	1380/1560	<b>07.1768</b>	597702F100-597702F200	•
Cerato 1,6 Hatchback all (LH-SX)	03/04=>	1395/1575	<b>07.1769</b>	597602F100-597602F200	•
Cee'd-Cee'd Sporty Wagon (LH-SX)	12/06=>	1475/1670	<b>07.1855</b>	597601H400	•
Cee'd-Cee'd Sporty Wagon (RH-DX)	12/06=>	1478/1675	<b>07.1856</b>	597701H400	•





<b>LADA</b>					
2101/2105 1,2-1,3-1,5-1,6 (front-avt)		475	<b>07.128</b>	21013508068	0,062
2102/2105 1,2-1,3-1,5-1,6		865+865/ 2510	<b>07.611</b>	21013508180	0,774
Samara all (LH/RH-SX/DX)		1390/1625	<b>07.001</b>	21083508180	0,533
Niva all (front-avt)		380	<b>07.626</b>	21213508068	0,052
Niva all		775+775/ 2130	<b>07.625</b>	21213508180	0,720

<b>LANCIA</b>					
A112 all	74=>	1150+1150/ 2625	<b>07.216</b>	4261127	0,783
Y10 all (exc.4WD)	85=>	970+970/ 2395	<b>07.102</b>	5972833-7573814	0,748
Y10 4WD	86=>	1035+1035/ 2690	<b>07.676</b>	4406021	0,848
Y10 all (exc.4WD)	92=>	975+975/ 2395	<b>07.757</b>	7757560	0,796

**COMANDI FLESSIBILI FUNE FRENO A MANO - BRAKE CABLES - CABLES DE FREIN  
BREMSEILE - CABLES DE FRENO - CABOS DE TRAVAO  
LINKI HAMULCA - BRZDOVÁ LANKA - ТРОСЫ РУЧНОГО ТОРМОЗА**





				OEM REF.	
<b>LANCIA</b>					
Y all (RH-DX)	96=>	1250/1415	<b>07.0446</b>	82487709	0,529
Y all (LH-SX)	96=>	1230/1395	<b>07.0447</b>	82487780	0,526
Ypsilon (LH/RH-SX/DX)	03=>	1200/1425	<b>07.1210</b>	46813948	0,478
Ypsilon all (RH-DX)	05/11=>	1258/1535	<b>07.1953</b>	51900232	•
Ypsilon all (LH-SX)	05/11=>	1258/1535	<b>07.1954</b>	51900231	•
Musa 1,4 16v-1,3 Jtd (LH/RH-SX/DX)	04=>	1305/1530	<b>07.1155</b>	51731443-51770286	0,492
Musa 1,9 Jtd (LH/RH-SX/DX)	04=>	1305/1555	<b>07.1156</b>	46847434-51770287	0,498
Musa 1,6 Mjtd 16v (LH/RH-SX/DX)	04/08=>	1430/1615	<b>07.1685</b>	51804860	0,541
Fulvia (compl.)		915+915/ 3800	<b>07.260</b>	82228501-81820025-82262902 81719820	0,285
Fulvia I° (5 speed)		675+675/ 1935	<b>07.265</b>	81820868	0,505
Fulvia II° (5 speed)		675+675/ 1935	<b>07.265</b>	81305065-81820868	0,505
Flavia		915+915/ 3800	<b>07.260</b>	82262902-81719820	0,285
Flavia		675+675/ 1935	<b>07.265</b>	81820868	0,505
Beta all	=>10/79	930+930/ 2170	<b>07.253</b>	82291382-82334114	0,725
Beta/Trevi all	11/79=>	960+960/ 2200	<b>07.795</b>	82370168	0,796
Beta Montecarlo		710+735/ 1990	<b>07.262</b>	4345206	0,653
Delta/Prisma all (front-avt)	80=>	595	<b>07.826</b>	82358459-82349790	0,133
Delta/Prisma all (front-avt)	86=>	290	<b>07.219</b>	82416095	0,060
Delta/Prisma 1,3-1,5	80=>	1240+1240/ 2885	<b>07.677</b>	82335639	1,018
Delta/Prisma 1,6-HF-TD	83=>	1130+1130/ 2510	<b>07.923</b>	82390483	0,915
Delta/Prisma 1,3-1,5	86=>	1400+1400/ 3110	<b>07.220</b>	82416097	1,201
Delta/Prisma 1,6-HF-TD	86=>	1230+1230/ 2075	<b>07.221</b>	82416096	1,006
Delta Integrale/Prisma 4WD	86=>	1320+1320/ 2885	<b>07.222</b>	82410629	1,111
Delta all (front-avt)	93=>	405	<b>07.149</b>	7609367-92323732	0,112
Delta 1,4-1,6 (drum brake) (RH-DX)	93=>	1025/1385	<b>07.154</b>	7615326	0,430
Delta 1,4-1,6 (drum brake) (LH-SX)	93=>	1063/1425	<b>07.156</b>	7615327	0,446
Delta 1,8-2,0 16v (RH-DX)	93=>	1135/1440	<b>07.997</b>	7615342	0,432
Delta 1,8-2,0 16v (LH-SX)	93=>	1155/1517	<b>07.0427</b>	7714822	0,505
Delta all (LH-SX)	07/08=>	1700/1902	<b>07.1790</b>	51808305	•
Delta all (RH-DX)	07/08=>	1567/1760	<b>07.1841</b>	51808304	•
Delta (844) all (LH-SX)	12/09=>	1748/1942	<b>07.1951</b>	51826008	•
Delta (844) all (RH-DX)	12/09=>	1613/1792	<b>07.1952</b>	51826007	•
Dedra all (front-avt)	89=>	405	<b>07.149</b>	7609367-92323732	0,112
Dedra 1,6 (drum brake) (RH-DX)	89=>	1025/1385	<b>07.154</b>	7615326	0,430
Dedra 1,6 (drum brake) (LH-SX)	89=>	1065/1425	<b>07.156</b>	7615327	0,446
Dedra 1,8-2,0 D-TD-1,6 antiskid (RH-DX)	89=>	1135/1440	<b>07.997</b>	7615342	0,432
Dedra 1,8-2,0 D-TD-1,6 antiskid (LH-SX)	89=>	1175/1480	<b>07.999</b>	7615343	0,467
Dedra 1,8-2,0-TD-1,6 antiskid (LH-SX)	92=>	1155/1517	<b>07.0427</b>	7714822	0,505
Dedra Integrale (LH-SX)	91=>	790/2415	<b>07.435</b>	82464806-60807561	0,423

**COMANDI FLESSIBILI FUNE FRENO A MANO - BRAKE CABLES - CABLES DE FREIN  
BREMSSEILE - CABLES DE FRENO - CABOS DE TRAVAO  
LINKI HAMULCA - BRZDOVÁ LANKA - ТРОСЫ РУЧНОГО ТОРМОЗА**





				OEM REF.	
<b>LANCIA</b>					
Dedra Integrale (RH-DX)	91=>	800/1190	<b>07.434</b>	82464807-60807562	0,435
Lybra all (front-avt)	99=>	385	<b>07.0419</b>	7773616	0,117
Lybra all (RH-DX)	99=>	900/1222	<b>07.0881</b>	46546713	0,408
Lybra all (LH-SX)	99=>	945/1266	<b>07.0882</b>	46546714	0,429
Gamma all		1040+1040/ 2400	<b>07.254</b>	82306816	0,824
Thema all (front-avt)	11/84=>	265	<b>07.131</b>	82399827-60807617	0,049
Thema all	11/84=>	1260+1400/ 2970	<b>07.132</b>	82390671-82441688	1,025
Thema all (with prot.)	92=>	1260+1400/ 2970	<b>07.097</b>	82481842	1,162
Kappa all (front-avt)	95=>	311	<b>07.0239</b>	82488247	0,119
Kappa all (RH-DX)	95=>	1175/1300	<b>07.0240</b>	82488245	•
Kappa all (LH-SX)	95=>	1221/1345	<b>07.0241</b>	82488246	0,594
Zeta all (front-avt)	95=>	255/500	<b>07.0166</b>	1472957080	0,132
Zeta all (drum brake) (LH-SX)		770/1065	<b>07.0167</b>	1473322080-4745F2	1,065
Zeta all (drum brake) (RH-DX)		2050/2310	<b>07.0168</b>	1473321080-4745F3	0,912
Zeta all (disc brake) (RH-DX)	95=>	2080/2205	<b>07.0169</b>	1472958080	0,817
Zeta all (disc brake) (LH-SX)	95=>	1060/1255	<b>07.0170</b>	1472959080-4745F4	0,444
Phedra (front-avt)	06/02=>	255/500	<b>07.0166</b>	1487276080-4745T5	0,132
Phedra (RH-DX)	06/02=>	2220/2360	<b>07.1105</b>	4745T8-4745T7-1487275080	0,807
Phedra (LH-SX)	06/02=>	840/1068	<b>07.1106</b>	4745T6-1487274080	0,326
Phedra all (RH-DX)	05=>	2150/2310	<b>07.1341</b>	1400310280-1400310180	0,840
Phedra all (LH-SX)	05=>	840/1041	<b>07.1342</b>	1400310380	0,408
Phedra 2,0 Jtd (disc brake) (LH/RH-SX/DX)	07=>	1115/1255	<b>07.1774</b>	1400204180	0,478

<b>MAZDA</b>					
121 New (front/avt)	96=>	315	<b>07.0619</b>	1E0044150-1E0044150A	0,355
121 New	96=>	1400/1585+ 1450/1635	<b>07.0620</b>	1E0044410A	1,297
2 all (front/avt)	02/03=>	312	<b>07.0619</b>	D35044150	0,355
2 all	02/03=>	1116/1305+ 1257/1445	<b>07.1176</b>	D35044400C	1,103
2 all (LH/RH-SX/DX)	02/03=>	175	<b>07.1177</b>	D35044400D	0,028
2 all (front/avt)	08=>	408	<b>07.1869</b>	D65144150B	•
2 all	08=>	160	<b>07.1895</b>	1514201-8V512A635AB	•
3 all (front/avt)	03=>	345	<b>07.1390</b>	BP4K44150C	0,046
3 all (RH-DX)	03=>	1745/1875	<b>07.1391</b>	BP4K44410L	0,657
3 all (LH-SX)	03=>	1700/1830	<b>07.1392</b>	BP4K44420K	0,648
5 all (RH-DX)	05=>	1680/1810	<b>07.1718</b>	C23644410E	•
5 all (LH-SX)	05=>	1700/1828	<b>07.1719</b>	C23644420E	•
6 all	05=>	1432/1640+ 1432/1645	<b>07.1720</b>	GJ6A44410A-GJ6A44410C	1,224

**COMANDI FLESSIBILI FUNE FRENO A MANO - BRAKE CABLES - CABLES DE FREIN  
BREMSSEILE - CABLES DE FRENO - CABOS DE TRAVAO  
LINKI HAMULCA - BRZDOVÁ LANKA - ТРОСЫ РУЧНОГО ТОРМОЗА**

				OEM REF.	
<b>MAZDA</b>					
323 1,3-1,4 (RH-DX)	77=>	370/1265	<b>07.893</b>	395844410	0,220
323 SW (LH-SX)	77=>	835/1350	<b>07.0029</b>	856544410	0,355
323 (front-avt)	81=>08/85	1520/2275	<b>07.0028</b>	B00144150-B00144150D B00144150E	0,853
323 1,1-1,5 (front-avt)	09/85=>		<b>07.0451</b>	B09244150	0,097
323 (BF mod.)-323 1,1-1,5 (drum brake) (RH-DX)	09/85=>	835/1420	<b>07.0200</b>	B09244410-B09244410A B09244410B-B09244410C B09244410D-BF6744410E	0,461
323 (BF mod.)-323 1,1-1,5 (drum brake) (LH-SX)	09/85=>	825/1410	<b>07.0201</b>	B09244420-B09244420A B09244420B-B09244420C B09244420D-BF6744420E	0,494
323 (BF mod.) (disc brake) (RH-DX)	85=>89	754/1333	<b>07.0883</b>	B10744410E	•
323 (BF mod.) (disc brake) (LH-SX)	85=>89	754/1341	<b>07.0884</b>	B10744420E	•
323 (BG mod.) 1,3-1,5-1,7 (drum brake) (RH-DX)	89=>94	1330/1500	<b>07.0245</b>	B46744410D-B46744410C	0,731
323 (BG mod.) 1,3-1,5-1,7 (drum brake) (LH-SX)	89=>94	1280/1470	<b>07.0246</b>	B46744420D-B46744420C	0,715
323 (BG mod.) (5 doors) (drum brake) (RH-DX)	89=>94	1275/1465	<b>07.0247</b>	B45544410D-B45544410E B45544410C	0,687
323 (BG mod.) (5 doors) (drum brake) (LH-SX)	89=>94	1325/1505	<b>07.0248</b>	B45544420D-B45544420E B45544420C	0,545
323 (BG mod.) (front-avt)	89=>96	280	<b>07.1522</b>	B45544150	0,099
323 (BG mod.) (4/5 doors) 2/4 WD (disc brake) (RH-DX)	02/89=>96	1210/1404	<b>07.1518</b>	B46144410C	0,587
323 (BG mod.) (4/5 doors) 2/4 WD (disc brake) (LH-SX)	02/89=>96	1210/1404	<b>07.1519</b>	B46144420C	0,599
323 BF Wagon (LH-SX)	86=>88	760/1420	<b>07.0512</b>	B21644420B-B21644420C	0,509
323 BF Wagon (RH-DX)	86=>88	760/1420	<b>07.0513</b>	B21644410B-B21644410C	0,503
323 BA1-323 F 2,0i (RH-DX)	04/94=>98	1312/1516	<b>07.1386</b>	BC1E44410C	0,608
323 BA1-323 F 2,0i (LH-SX)	04/94=>98	1312/1519	<b>07.1387</b>	BC1E44420D	0,616
323 BA (4 doors) (LH-SX)	04/94=>98	1450/1653	<b>07.1520</b>	BC1D44420B-BC1D44420C	0,718
323 BA (4 doors) (RH-DX)	04/94=>98	1450/1653	<b>07.1521</b>	BC1D44410B-BC1D44410C	0,703
323 P (5 doors) 1,3-1,5-D (RH-DX)	10/96=>98	1345/1545	<b>07.1516</b>	BC1B44410A	0,670
323 P (5 doors) 1,3-1,5-D (LH-SX)	10/96=>98	1355/1545	<b>07.1517</b>	BC1B44420A	0,698
323 BJ all (disc brake) (RH-DX)	98=>03	1500/1715	<b>07.1206</b>	GE7C44410D	•
323 BJ all (disc brake) (LH-SX)	98=>03	1480/1693	<b>07.1207</b>	GE7C44420D	0,610
323 BJ all (drum brake) (RH-DX)	98=>03	1394/1660	<b>07.1388</b>	B25D44410B-B25D44410C	0,598
323 BJ all (drum brake) (LH-SX)	98=>03	1375/1640	<b>07.1389</b>	B25D44420B-B25D44420C	0,588
616 1,6	70=>73	300/1365	<b>07.894</b>	230544410	0,215
616 all	09/73=>78	310/1340	<b>07.895</b>	194244410A	0,219
626 all (LH/RH-SX/DX)	79=>	435/1410	<b>07.896</b>	823944410	0,269
626 1,6-2,0 (front-avt)	82=>87	235	<b>07.0650</b>	G03044150B	0,097
626 all (RH-DX)	83=>87	890/1590	<b>07.0030</b>	G03044410E-G03044410F	0,424
626 all (LH-SX)	83=>87	890/1590	<b>07.0031</b>	G03044420E-G03044420F	0,474
626 1,6-2,0 (front-avt)	06/87=>	255	<b>07.0034</b>	GJ2144150	0,074
626 (4/5 doors) (disc brake) (RH-DX)	06/87=>	1510/1685	<b>07.0032</b>	G21344410-G21344410A G21344410C-G21344410E	0,802
626 (4/5 doors) (disc brake) (LH-SX)	06/87=>	1535/1700	<b>07.0033</b>	G21344420F	0,822
626 (4 doors) (drum brake) (RH-DX)	06/87=>	1420/1630	<b>07.0035</b>	G21744410C-G21744410F G21744410G	0,785
626 (4 doors) (drum brake) (LH-SX)	06/87=>	1440/1650	<b>07.0036</b>	G21744420-G21744420B G21744420H	0,786
626 1,6-2,0 (OHC) (2 doors) (RH-DX)	09/87=>	1365/1575	<b>07.0251</b>	GJ2144410H	0,708
626 1,6-2,0 (OHC) (2 doors) (LH-SX)	09/87=>	1380/1585	<b>07.0252</b>	GJ2144420K	0,747

**COMANDI FLESSIBILI FUNE FRENO A MANO - BRAKE CABLES - CABLES DE FREIN  
BREMSSEILE - CABLES DE FRENO - CABOS DE TRAVAO  
LINKI HAMULCA - BRZDOVÁ LANKA - ТРОСЫ РУЧНОГО ТОРМОЗА**

				OEM REF.	
<b>MAZDA</b>					
626 1,6-2,0-MX6 (2 doors) (RH-DX)	89=>91	1460/1630	<b>07.0253</b>	GJ2544410G-GJ2544410E GJ2544410D	0,787
626 1,6-2,0-MX6 (2 doors) (LH-SX)	89=>91	1470/1640	<b>07.0254</b>	GJ2544420G-GJ2544420J GJ2544420H	0,781
626/MX6 all (front-avt)	98=>	400	<b>07.1201</b>	GD7A44150	0,105
626/MX6 all (RH-DX)	98=>	1725	<b>07.1202</b>	GD7A44410	0,722
626/MX6 all (LH-SX)	98=>	1725	<b>07.1203</b>	GD7A44420	0,735
626 (4/5 doors) all (drum brake) (RH-DX)	98=>	1453/1685	<b>07.1204</b>	GE4T44410D-GE4T44410B	0,649
626 (4/5 doors) all (drum brake) (LH-SX)	98=>	1433/1665	<b>07.1205</b>	GE4T44420D-GE4T44420B	•
626 (4/5 doors) all (disc brake) (RH-DX)	98=>	1500/1715	<b>07.1206</b>	GE7C44410D-GE7C44410B	•
626 (4/5 doors) all (disc brake) (LH-SX)	98=>	1480/1693	<b>07.1207</b>	GE7C44420D-GE7C44420B	0,610
626 GT (disc brake) (LH-SX)	85=>88	995/1585	<b>07.0514</b>	G03744420E-G03744420G	0,517
626 GT (disc brake) (RH-DX)	85=>88	995/1585	<b>07.0515</b>	G03744410E-G03744410G	0,513
626 GE-MX6 all (front-avt)	02/92=>97	250	<b>07.0662</b>	GA5R44150C	0,074
626 GE-MX6 all (RH-DX)	02/92=>97	1445/1655	<b>07.0663</b>	GA5R44410C	0,706
626 GE-MX6 all (LH-SX)	02/92=>97	1445/1655	<b>07.0664</b>	GA5R44420D	0,726
626 all (LH-SX)	00=>02	1555/1764	<b>07.1608</b>	G14T44420B	•
626 all (RH-DX)	00=>02	1570/1777	<b>07.1609</b>	G14T44410B	•
929-929 SW (LH-SX)	74=>79	480/1420	<b>07.0037</b>	174544410	•
929	80=>81	440/1700	<b>07.0038</b>	859544410	0,256
929	82=>	480/1395	<b>07.0039</b>	H00144410H	0,257
929	84=>	485/1350	<b>07.0040</b>	H12044410	0,306
MX3 all (RH-DX)	92=>	1340	<b>07.0666</b>	EA0344410A	0,596
MX3 all (LH-SX)	92=>	1345	<b>07.0667</b>	EA0344420A	0,598
MX5 all (LH-SX)	98=>	1002/1175	<b>07.1716</b>	NA0144420B	•
MX5 all (RH-DX)	98=>	1002/1175	<b>07.1717</b>	NA0144410B	0,435
MX5 all (LH-SX)	00=>04	963/1143	<b>07.1955</b>	NC1044410A-NC1044410B	•
MX5 all (RH-DX)	00=>04	963/1143	<b>07.1956</b>	NC1044420A-NC1044420B	•
Pick-Up B1600 Long Body (RH-DX)	85=>	1160/2739	<b>07.1208</b>	UB7144410	0,793
Pick-Up B1600 Long Body (LH-SX)	85=>	1338/2555	<b>07.1209</b>	UB7144420	•
E1,8-2,0-2,2 Van/Wagon (LH-RH/SX-DX)	84=>	1170/1900	<b>07.0516</b>	S08344410A-S08344410B S08344410C	0,819





**M.C.C.**

Smart all (LH/RH-SX/DX)		805/1000	<b>07.1041</b>	204220047	0,321
Smart Roadster (LH/RH-SX/DX)		865/1035	<b>07.1523</b>	0018975V001	•
Forfour 1,1 (drum brake) (RH-DX)	04=>	1345/1560	<b>07.1791</b>	4544200085	•
Forfour 1,1 (drum brake) (LH-SX)	04=>	1315/1525	<b>07.1792</b>	4544200185	•
Forfour 1,5 Cdi (disc brake) (RH-DX)	04=>	1420/1570	<b>07.1793</b>	4544200485	•
Forfour 1,5 Cdi (disc brake) (LH-SX)	04=>	1390/1540	<b>07.1794</b>	4544200385	•

**MERCEDES**

190 all (front-avt)	84=>	540	<b>07.146</b>	2014200485	0,033
190 SL (front-avt)	84=>	335	<b>07.147</b>	1214200085	0,016
190-190E all (LH/RH-SX/DX)	06/83=>85	808/1060	<b>07.232</b>	2014200685-2014201185	0,456
190 (LH/RH-SX/DX)	85=>	808/1060	<b>07.232</b>	1244201185-2014200785	0,456

**COMANDI FLESSIBILI FUNE FRENO A MANO - BRAKE CABLES - CABLES DE FREIN  
BREMSEILE - CABLES DE FRENO - CABOS DE TRAVAO  
LINKI HAMULCA - BRZDOVÁ LANKA - ТРОСЫ РУЧНОГО ТОРМОЗА**

				OEM REF.	
<b>MERCEDES</b>					
A Class all LWB long (front-avt)	97=>98	665/1153	<b>07.1397</b>	1684202085	•
A Class (ch. J016124-) (RH-DX)	97=>98	385/987	<b>07.1398</b>	1684201385	0,209
A Class 140-160-170D (ch. A000002-) (LH-SX)	98=>	505/1065	<b>07.0582</b>	1684201485	0,208
A Class 190 (LH-SX)	03/01=>02	520/1046	<b>07.1121</b>	1684200685	•
A Class 190-210 Evolution (LH-SX)	06/99=>	520/1038	<b>07.1122</b>	1684201985	0,227
A Class 190-210 Evolution (RH-DX)	06/99=>	520/685	<b>07.1123</b>	1684200785	0,208
A Class 140-160-170D (LH-SX)	98=>	503/1056	<b>07.0836</b>	1684201785	0,210
A Class 140-160-170D (RH-DX)	98=>	500/732	<b>07.0583</b>	1684200585-1684201585	0,201
A Class all SWB short (front-avt)	06/99=>	385/987	<b>07.1396</b>	1684201685	0,219
A Class 140-160-170D (-ch. A000001) (LH-SX)	98=>	498/1062	<b>07.1528</b>	1684200285	0,204
A Class all (front-avt)	05=>	1105/1307	<b>07.1393</b>	1694200985	•
A Class all (LH-SX)	05=>	476/587	<b>07.1526</b>	1694201185	•
A Class all (RH-DX)	05=>	1065/1215	<b>07.1527</b>	1694201285	•
B Class all (front-avt)	05=>	1105/1307	<b>07.1393</b>	1694200985	•
B Class all (LH-SX)	05=>	476/587	<b>07.1526</b>	1694201185	•
B Class all (RH-DX)	05=>	1065/1215	<b>07.1527</b>	1694201285	•
C Class 180-200-220-250D-280 (front-avt)	94=>00	2370/2570	<b>07.0517</b>	2024200887-2024201685	1,091
C Class 180-200-220-250D-280 (LH-SX)	94=>00	805/965	<b>07.0518</b>	2024200185-2024202285	0,460
C Class 180-200-220-250D-280 (RH-DX)	94=>00	700/930	<b>07.0519</b>	2024200285-2024202385	0,445
C Class all (front-avt)	94=>00	2400/2555	<b>07.1112</b>	2024203285	0,751
C Class Sportcoupé/Clk (front-avt)	94=>00	1933/2065	<b>07.1113</b>	2024203385	•
C Class all/T mod. (front-avt)	00=>	2005/2158	<b>07.1114</b>	2034200685	0,658
C Class Sportcoupé/Clk (front-avt)	00=>	2586/2735	<b>07.1115</b>	2034200185-2034200985	•
C Class all (LH-SX)	00=>	805/925	<b>07.1124</b>	2034200285	•
C Class all (RH-DX)	00=>	785/900	<b>07.1125</b>	2034200385	0,291
E Class 200-220D-300-420D (LH-SX)	95=>02	830/1070	<b>07.0584</b>	2104201085-2104201485	0,472
E Class 200-220D-300-420D (RH-DX)	95=>02	810/1050	<b>07.0585</b>	2104201185-2104201585	0,465
E Class 200-220D-300-420D (front-avt)	95=>02	2423/2613	<b>07.0837</b>	2104201885-2104200885	•
E Class all (front-avt)	02=>	1290/1433	<b>07.1116</b>	2114200585	•
E Class all (front-avt)	02=>	1810/1950	<b>07.1117</b>	2114200185	•
E Class all (LH/RH-SX/DX)	02=>	1557/1725	<b>07.1126</b>	2114200285-2114200385	0,577
E Class (212) all (LH/RH-SX/DX)	09=>	602/743	<b>07.1872</b>	2124200185	•
SLK 200-230 (LH-SX)	97=>	837/1005	<b>07.0838</b>	1704200385	0,371
SLK 200-230 (RH-DX)	97=>	823/994	<b>07.0839</b>	1704200485	0,364
SLK 200-280-350-55 AMG (RH-DX)	04=>	780/1004	<b>07.1721</b>	1714200285	•
SLK 200-280-350-55 AMG (LH-SX)	04=>	646/760	<b>07.1722</b>	1714200185	•
S Class (front-avt)	99=>	2235/2760	<b>07.1118</b>	2204200985	•
S Class (LH-SX)	99=>	814/992	<b>07.1127</b>	2204202785	0,360
S Class (RH-DX)	99=>	800/978	<b>07.1128</b>	2204202885	0,303
M Class SWB ML320-230-430-270Cdi-400Cdi-500 (front-avt)	98=>	1276/1445	<b>07.1119</b>	1634200385	0,431
M Class LWB ML320-230-430-270Cdi-400Cdi-500 (front-avt)	98=>	1600/1780	<b>07.1120</b>	1634200285	•
M Class ML320-230-430-270Cdi-400Cdi-500 (LH-SX)	98=>	1868/2025	<b>07.1129</b>	1634200785-501210310E	•

**COMANDI FLESSIBILI FUNE FRENO A MANO - BRAKE CABLES - CABLES DE FREIN  
BREMSSEILE - CABLES DE FRENO - CABOS DE TRAVAO  
LINKI HAMULCA - BRZDOVÁ LANKA - ТРОСЫ РУЧНОГО ТОРМОЗА**





				<b>OEM REF.</b>	
---	---	---	--	-----------------	---

<b>MERCEDES</b>					
M Class ML320-230-430-270Cdi-400Cdi-500 (RH-DX)	98=>	1775/1930	<b>07.1130</b>	1634200885-501210311C	•
M Class ML320 (LH/RH-SX/DX)	05=>	715/817	<b>07.1610</b>	1644200385-1644202385	•
200-230-250-300 E-D-TE-TD (front-avt)	85=>	1920/2515	<b>07.184</b>	1244201085-1244202685	0,891
200-200D-220-220D-230-250-280	68=>73	850/1510	<b>07.376</b>	1154202685	0,355
200D-230-250S (centr.)	68=>	1435/1685	<b>07.373</b>	1154201685	0,672
200/8-280/8	73=>76	825/1500	<b>07.696</b>	1154202785	0,471
200/8-250/8-300D-300TD (LH-SX)	76=>	1235/1645	<b>07.689</b>	1234200485	0,607
200/8-250/8-300D-300TD (RH-DX)	76=>	1330/1625	<b>07.690</b>	1234200585	0,660
200-230-250-260-300 all (LH/RH-SX/DX)	85=>	808/1060	<b>07.232</b>	1244201185-2014200785	0,456
200D-220D-230-240D-240TD-250T-280-300D 300TD (centr.)	76=>	1400/1740	<b>07.791</b>	1234200285	0,660
230-300-320 CE (front-avt)	85=>	1920/2430	<b>07.210</b>	1244201285-1244202585	0,890
260-280-380-420-500 (LH-SX)	12/79=>	880/1090	<b>07.752</b>	1264201685	0,488
260-280-380-420-500 (RH-DX)	12/79=>	890/1110	<b>07.756</b>	1264201785	0,497
280SEL-300SL (USA mod.) (front-avt)	12/79=>	2445/2640	<b>07.0160</b>	1264200885	•
300-400-500-600SE-SEL-300S TD (RH-DX)	79=>91	911/1121	<b>07.1109</b>	1404201085-1404202085	•







<b>MERCEDES - Commercial Vehicle</b>					
Vaneo 1,6-1,9-Cdi (414) (front-avt)	02/02=>	860/1463	<b>07.1399</b>	4144200185	0,323
Vaneo 1,6-1,9-Cdi (414) (LH-SX)	02/02=>	520/1038	<b>07.1122</b>	1684201985	0,227
Vaneo 1,6-1,9-Cdi (414) (RH-DX)	02/02=>	520/685	<b>07.1123</b>	1684200785	0,208
Vito all (centr.)	97=>	2720/2925	<b>07.0586</b>	6384200785	1,288
Vito all (LH-SX/RH-DX)	97=>	910/1170	<b>07.0587</b>	6384270338	0,456
Vito all (RH-DX)	06=>	903/1152	<b>07.1732</b>	6394270538	•
Vito all (LH-SX)	06=>	1037/1285	<b>07.1733</b>	6394270438	•
Vito all 4x4 (centr.)	06=>	1750/2815	<b>07.1734</b>	6394201785	•
Vito all Compact/Long (centr.)	06=>	1370/2432	<b>07.1735</b>	6394201485	•
Vito all Extralong (centr.)	06=>	1733/2799	<b>07.1736</b>	6394201385	•
V Serie Van all (centr.)	97=>	2720/2925	<b>07.0586</b>	6384200785	1,288
V Serie Van all (LH-SX/RH-DX)	97=>	910/1170	<b>07.0587</b>	6384270338	0,456
L206-L207-L306-L307 (front-avt)	73=>	750/1200	<b>07.950</b>	6034200185-6034200285	0,328
L408-L410D all (RH-DX)	11/88=>	1100/1750	<b>07.1957</b>	6114201785	0,510
L408-L410D all (LH-SX)	11/88=>	1100/1750	<b>07.1958</b>	6114201685	0,518
207D-208-210-308-310 (front-avt)	77=>	210	<b>07.383</b>	6014201585	0,041
207D-208-210-308-310 SWB (centr.)	77=>	830	<b>07.386</b>	6014201685	0,073
207D-208-210-308-310 MWB (centr.)	77=>	1130	<b>07.388</b>	6014201785	0,089
207D-208-210-308-310 LWB (centr.)	77=>	1480	<b>07.389</b>	6014201885	0,107
207D-208-210-308-310-601-602	77=>	930/1800	<b>07.390</b>	6014201185	0,443





**COMANDI FLESSIBILI FUNE FRENO A MANO - BRAKE CABLES - CABLES DE FREIN  
BREMSEILE - CABLES DE FRENO - CABOS DE TRAVAO  
LINKI HAMULCA - BRZDOVÁ LANKA - ТРОСЫ РУЧНОГО ТОРМОЗА**

				OEM REF.	
<b>MERCEDES - Commercial Vehicle</b>					
207D-310D (RH-DX)	86=>	950/1860	<b>07.0588</b>	6014204785-6014203485	0,500
207D-310D (LH-SX)	86=>	950/1860	<b>07.0589</b>	6014204685-6014203385	0,497
609D-611D-709D-711D-714D-809D-811D (LH-SX)	86=>94	732/1023	<b>07.1524</b>	6684202885-6684204285	0,510
609D-611D-709D-711D-714D-809D-811D(RH-DX)	86=>94	817/1108	<b>07.1525</b>	6684202985-6684204385	0,534
MB 130 (front-avt)		1080	<b>07.1145</b>	6314200185	•
MB 150 (front-avt)		1330	<b>07.1146</b>	6314200285	•
MB 100-120-140 (front-avt)	09/87=>	490/1650	<b>07.403</b>	6314201985	0,310
MB 140-160-180 (front-avt)	09/87=>	490/1420	<b>07.404</b>	6314202085	0,292
MB 100-120-140-160-180 (LH/RH-DX/SX)	09/87=>	1020/1440	<b>07.405</b>	6314201285	0,453
MB 130-150 (LH-SX)		1535	<b>07.1147</b>	6314200485	•
MB 130-150 (RH-DX)		1695	<b>07.1148</b>	6314200585	0,374
Sprinter (-ch.3000) Tel WDB903663 mod.903.663.01 (front-avt)	97=>	285/1435	<b>07.1131</b>	9014202085-2D0609701	•
Sprinter (-ch.3000) Tel WDB903663 mod.903.663.06 (front-avt)	97=>	285/1415	<b>07.1132</b>	9014202785	0,222
Sprinter (-ch.3550) Tel WDB903663 mod.903.363.02 903.363.04 (front-avt)	97=>	285/1970	<b>07.1133</b>	2D0609701C-9044200385 9014202180	0,247
Sprinter (-ch.4025) Tel WDB903663 mod.903.663.03 (front-avt)	97=>	285/2460	<b>07.1134</b>	9014202285-2D0609701B	0,270
Sprinter (-ch.3000) Tel WDB903663 mod.741.408.01 (LH/RH-DX/SX)	97=>	1330/1515	<b>07.1135</b>	9014201885-2D0609721	0,687
Sprinter Tel WDB903663 mod.741.408.04 (LH/RH-DX/SX)	97=>	1360/1545	<b>07.1136</b>	9014202885	0,673
Sprinter 4T (-ch.3550) Tel WDB903663 mod.741.408.02 (LH-SX)	97=>	1350/1525	<b>07.1137</b>	9044200185-2D0609721A	0,746
Sprinter 4T (-ch.3550) Tel WDB903663 mod.741.408.02 (RH-DX)	97=>	1350/1525	<b>07.1138</b>	9044200285-2D0609722	0,789
Sprinter 4T (-ch.3550) Tel WDB903663 mod.741.408.05 (LH-SX)	97=>	1390/1565	<b>07.1139</b>	9044200585	0,685
Sprinter 4T (-ch.3550) Tel WDB903663 mod.741.408.05 (RH-DX)	97=>	1390/1565	<b>07.1140</b>	9044200685	0,839
Sprinter mod. 411 cdi (LH-SX)	97=>	1505/1680	<b>07.1141</b>	6674204685	0,718
Sprinter mod. 411 cdi (RH-DX)	97=>	1500/1680	<b>07.1142</b>	6674204785	0,718
Sprinter chassis Cab Van T 4,6 (double wheels) (front-avt)	97=>	285/2440	<b>07.1309</b>	9044200485-2D0609701D	0,268
Sprinter (ch. 3550) (single wheel) (front-avt)	97=>	285/1990	<b>07.1306</b>	9014202185-2D0609701A	0,250
Sprinter all (ch. 3250) (front-avt)	06=>	365/1468	<b>07.1723</b>	9064202485-2E3609701A	0,186
Sprinter all (ch. 3250) cab.rib. (front-avt)	06=>	271/1374	<b>07.1724</b>	2E3609701R-9064202885	•
Sprinter all (ch. 3665) (front-avt)	06=>	365/1867	<b>07.1725</b>	9064202285-2E0609721L	•
Sprinter all (ch. 3665) cab.rib. (front-avt)	06=>	1271/1771	<b>07.1726</b>	2E0609701P-9064202685	•
Sprinter all (ch. 4325) (front-avt)	06=>	365/2522	<b>07.1727</b>	2E0609701M	•
Sprinter all (ch. 4325) cab.rib. (front-avt)	06=>	271/2425	<b>07.1728</b>	2E0609701Q-9064202785	•
Sprinter all pt. 5t (LH/RH-SX/DX)	06=>	1065/1394	<b>07.1729</b>	2E0609701T-9064203085	•
Sprinter all pt. 5t (double wheels) (LH/RH-SX/DX)	06=>	1112/1432	<b>07.1730</b>	2E0609701AA-9064203185	•
Sprinter all pt. 3t-3,2t-3,5t-4,6t (LH/RH-SX/DX)	06=>	1407/1666	<b>07.1731</b>	2E0609701J-9064202085	•
Sprinter all pt. 5t (double wheels) (LH/RH-SX/DX)	06=>	1102/1430	<b>07.1906</b>	9064204585	•
Sprinter all (5 tons) (LH/RH-SX/DX)	06=>	1060/1395	<b>07.1729</b>	9064204485-9064203085 9064207085	•
Sprinter all pt. 3t-3,2t-3,5t-4,6t (LH/RH-SX/DX)	09=>	1447/1706	<b>07.1959</b>	9064202985-9064206985	0,533
Vario 512D (double wheels) (LH-SX)	97=>	1505/1680	<b>07.1141</b>	6674204685	0,718
Vario 512D (double wheels) (RH-DX)	97=>	1500/1680	<b>07.1142</b>	6674204785	0,718





**COMANDI FLESSIBILI FUNE FRENO A MANO - BRAKE CABLES - CABLES DE FREIN  
BREMSSEILE - CABLES DE FRENO - CABOS DE TRAVAO  
LINKI HAMULCA - BRZDOVÁ LANKA - ТРОСЫ РУЧНОГО ТОРМОЗА**

				OEM REF.	
<b>MITSUBISHI</b>					
Colt 1,2-1,4 (4 doors) (LH-RH/SX-DX)	79=>83	1265/1480	<b>07.0044</b>	MB004799-MB193974	0,531
Colt all (LH/RH-SX/DX)	84=>	1190/1365	<b>07.0046</b>	MB256179	0,359
Colt all (LH-SX)	89=>91	1320/1485	<b>07.0256</b>	MB520341-MB520341C	0,567
Colt all (RH-DX)	89=>91	1330/1490	<b>07.0257</b>	MB520342-MB520342C	0,570
Colt all (disc brake) (LH-SX)	89=>02	1312/1442	<b>07.1737</b>	MB520347	•
Colt all (disc brake) (RH-DX)	89=>02	1320/1446	<b>07.1738</b>	MB520348	•
Colt all/Dodge Summit (USA mod.) (LH-RH/SX-DX)	92=>	1330/1510	<b>07.0885</b>	MB806051	0,589
Colt 1,3-1,5-1,6 (RH-DX)	95=>99	1176/1349	<b>07.1611</b>	MR129920	0,515
Colt 1,3-1,5-1,6 (LH-SX)	95=>99	1222/1394	<b>07.1612</b>	MR129919	0,528
Colt VI all 1,1-1,3 (drum brake) (RH-DX)	04=>	1345/1560	<b>07.1791</b>	MR955256	•
Colt VI all 1,1-1,3 (drum brake) (LH-SX)	04=>	1315/1525	<b>07.1792</b>	MR955255	•
Colt VI all 1,1-1,3 (disc brake) (RH-DX)	04=>	1420/1570	<b>07.1793</b>	MR955260	•
Colt VI all 1,3-1,5 (disc brake) (LH-SX)	04=>	1390/1540	<b>07.1794</b>	4544200385	•
Lancer-Celeste all (LH/RH-SX/DX)	80=>	920/1245	<b>07.0049</b>	MB004622	0,399
Lancer-Celeste GT-GSR (LH-SX)	80=>	890/1240	<b>07.0047</b>	MT402434	0,385
Lancer-Celeste GT-GSR (RH-DX)	80=>	885/1245	<b>07.0048</b>	MT402435	0,346
Lancer 1,2-1,3-1,5-1,6-1,8D (LH/RH-SX/DX)	84=>88	1190/1365	<b>07.0046</b>	MB256179	0,359
Lancer 1,3-1,5-D (LH-SX)	89=>91	1310/1485	<b>07.0256</b>	MB520341	0,567
Lancer 1,3-1,5-D (RH-DX)	89=>91	1317/1490	<b>07.0257</b>	MB520342	0,570
Lancer all (disc brake) (LH-SX)	89=>02	1312/1442	<b>07.1737</b>	MB520347	•
Lancer all (disc brake) (RH-DX)	89=>02	1320/1446	<b>07.1738</b>	MB520348	•
Lancer 1,3-1,5-1,6 (RH-DX)	95=>99	1176/1349	<b>07.1611</b>	MR129920	0,515
Lancer 1,3-1,5-1,6 (LH-SX)	95=>99	1222/1394	<b>07.1612</b>	MR129919	0,528
Galant 1,6-1,8 T-1,8D (LH-SX)	85=>88	1450/1630	<b>07.0670</b>	MB520200	0,666
Galant 1,6-1,8 T-1,8D (RH-DX)	85=>88	1480/1660	<b>07.0671</b>	MB520201-MB256297	•
Galant EA2A-WA5A-EA2/3/5W (LH-SX)	97=>	1585/1851	<b>07.1211</b>	MR205491	0,684
Galant EA2A-WA5A-EA2/3/5W (RH-DX)	97=>	1610/1876	<b>07.1212</b>	MR205492	0,685
Space Wagon/Vista SW (LH/RH-SX/DX)	85=>90	1400/1595	<b>07.0672</b>	MB520446-MB256275	0,541
Space Wagon (LH-SX)	00=>	1735/1917	<b>07.1213</b>	MR510573	•
Spacestar all (RH-DX)	05/02=>	1400/1540	<b>07.1739</b>	MR915064	0,527
Spacestar all (LH-SX)	05/02=>	1422/1563	<b>07.1740</b>	MR915063	•
Pajero 2,6-D (RH-DX)	83=>88	990/1185	<b>07.0050</b>	MB256340-MB140463	0,588
Pajero 2,6-D (LH-SX)	83=>88	990/1180	<b>07.0259</b>	MB140462	0,471
Pajero 2,6-D-L047G-48G Wagon (RH-DX)	85=>	1245/1435	<b>07.0051</b>	MB256372	0,577
Pajero 2,6-D-L047G-48G Wagon (LH-SX)	85=>	1240/1435	<b>07.0453</b>	MB256371	0,558
Pajero/Shogun (66/77Kw) (front-avt)	99=>	220	<b>07.0835</b>	MR128810	0,099
Pajero/Shogun (66Kw) (RH-DX)	99=>	1182/1387	<b>07.0888</b>	MR475598	0,535
Pajero/Shogun (66Kw) (LH-SX)	99=>	1135/1340	<b>07.0889</b>	MR475597	•
Pajero/Shogun (77Kw) (RH-DX)	99=>	1354/1559	<b>07.0890</b>	MR475604	0,579
Pajero/Shogun (77Kw) (LH-SX)	99=>	1256/1462	<b>07.0891</b>	MR475603	•
L200 4WD 2,5 TD Intercooler all (RH-DX)	86=>	1780/1990	<b>07.1795</b>	MR128204	•
L200 4WD 2,5 TD Intercooler all (LH-SX)	86=>	1790/1995	<b>07.1796</b>	MR128203	•
Carisma (DA1A-DA2-DA4A) (LH-SX)	05/96=>	1328/1511	<b>07.0886</b>	MB950335	0,470
Carisma (DA1A-DA2-DA4A) (RH-DX)	05/96=>	1328/1511	<b>07.0887</b>	MB950336	0,493





**COMANDI FLESSIBILI FUNE FRENO A MANO - BRAKE CABLES - CABLES DE FREIN  
BREMSSEILE - CABLES DE FRENO - CABOS DE TRAVAO  
LINKI HAMULCA - BRZDOVÁ LANKA - ТРОСЫ РУЧНОГО ТОРМОЗА**

				OEM REF.	
<b>NISSAN</b>					
Micra 1,0 (LH-SX)	83=>88	750/1000	<b>07.0145</b>	3653105B10	0,380
Micra 1,0 (RH-DX)	83=>88	1080/1360	<b>07.0144</b>	3640005B10	0,497
Micra N10-N12 (LH-SX)	88=>	740/1000	<b>07.0454</b>	3653121B00	0,340
Micra N10-N12 (RH-DX)	88=>	1100/1355	<b>07.0455</b>	3640021B00	0,494
Micra all ( <b>front-avt</b> )	93=>	250	<b>07.1214</b>	3640250J10-3640270J10	0,110
Micra all (LH-SX)	93=>	1200/1410	<b>07.0459</b>	365314F100	0,611
Micra all (RH-DX)	93=>	1225/1435	<b>07.0460</b>	365304F100	0,596
Micra K11 1,5 D (disc brake) (LH-SX)	02/98=>08/99	1070/1287	<b>07.1400</b>	365314F400	0,485
Micra K11 1,5 D (disc brake) (RH-DX)	02/98=>08/99	1093/1310	<b>07.1401</b>	365304F400	0,534
Micra K12 all ( <b>front-avt</b> )	04=>	200	<b>07.1402</b>	36402AX000	0,095
Micra K12 all (LH-SX)	04=>	1330/1540	<b>07.1403</b>	36531AX601	0,439
Micra K12 all (RH-DX)	04=>	1387/1604	<b>07.1404</b>	36530AX601	0,614
Pixo all (RH-DX)	10=>	1224/1440	<b>07.1967</b>	365304A00C	0,560
Pixo all (LH-SX)	10=>	1238/1455	<b>07.1968</b>	365314A00C	0,580
Cherry 100A-Van ( <b>front-avt</b> )	70=>77	525	<b>07.926</b>	36450M0701	0,039
Cherry 100A-F11	70=>77	1630	<b>07.925</b>	36451M0200	0,073
Cherry 120A-140A (LH-SX)		930	<b>07.0052</b>	36451M6600	0,080
Cherry 120A-140A (RH-DX)		745	<b>07.0053</b>	36450M6600	0,044
Cherry (LH-SX)	77=>	970	<b>07.932</b>	36451M7102	0,094
Cherry (RH-DX)	77=>	805	<b>07.933</b>	36450M7101	0,044
Cherry N12 (LH-SX)	83=>	730/1100	<b>07.0054</b>	3653101A01-3653104A01	0,318
Cherry N12 (RH-DX)	83=>	680/900	<b>07.0055</b>	3653001A01-3653004A01	0,287
Sunny N13 ( <b>front-avt</b> )	=>10/88	325	<b>07.0462</b>	36402D4000	0,102
Sunny N13 ( <b>front-avt</b> )	11/88=>	315	<b>07.0463</b>	3640251E00	0,103
Sunny T 2,0i Abd mod. ( <b>front-avt</b> )	07/90=>	250	<b>07.1214</b>	3640250J10	0,110
Sunny N13 (LH-SX)	86=>91	1225/1450	<b>07.0464</b>	3653150M01-3653160M01	0,635
Sunny N13 (RH-DX)	86=>91	1280/1455	<b>07.0465</b>	3653050M01-3653060M01 3645150A00	0,672
Sunny B11 SW (LH-SX)	89=>91	705/1080	<b>07.0521</b>	3653125A01	0,268
Sunny B11 SW (RH-DX)	89=>91	630/875	<b>07.0522</b>	3653025A01	0,247
Sunny 1,4-1,6-D (LH-SX)	91=>	1220/1415	<b>07.0523</b>	3653150Y10	0,576
Sunny 1,4-1,6-D (RH-DX)	91=>	1220/1415	<b>07.0524</b>	3653050Y10	0,604
Sunny 1,6-2,0 antiskid (LH-SX)	91=>	1140/1310	<b>07.0525</b>	3653151Y10	0,590
Sunny 1,6-2,0 antiskid (RH-DX)	91=>	1140/1310	<b>07.0526</b>	3653051Y10	0,605
Pulsar (LH-SX)	09/82=>86	730/1100	<b>07.0054</b>	3653101A01-3653104A01	0,318
Pulsar (RH-DX)	09/82=>86	700/900	<b>07.0055</b>	3653001A01-3653004A01	0,287
Pulsar NX (LH-SX)	86=>91	1225/1450	<b>07.0464</b>	3653150M01-3653160M01	0,635
Pulsar NX (RH-DX)	86=>91	1280/1455	<b>07.0465</b>	3653050M01-3653060M01 3645150A00	0,672
Pulsar 1,4-1,6-D (LH-SX)	91=>	1220/1415	<b>07.0523</b>	3653150Y10	0,576
Pulsar 1,4-1,6-D (RH-DX)	91=>	1220/1415	<b>07.0524</b>	3653050Y10	0,604
Pulsar 1,6-2,0 antiskid (LH-SX)	91=>	1140/1310	<b>07.0525</b>	3653151Y10	0,590
Pulsar 1,6-2,0 antiskid (RH-DX)	91=>	1140/1310	<b>07.0526</b>	3653051Y10	0,605
Prarie N10 1,5 (LH-SX)	83=>85	790/1860	<b>07.0531</b>	3653101R00	0,582
Prarie N10 1,5 (RH-DX)	83=>85	1100/1450	<b>07.0532</b>	3653001R00	0,425
Prarie N10 1,5 (LH-SX)	85=>88	780/1855	<b>07.0533</b>	3653122R00	0,638
Prarie N10 1,5 (RH-DX)	85=>88	1090/1445	<b>07.0534</b>	3653022R00	0,792







**COMANDI FLESSIBILI FUNE FRENO A MANO - BRAKE CABLES - CABLES DE FREIN  
BREMSSEILE - CABLES DE FRENO - CABOS DE TRAVAO  
LINKI HAMULCA - BRZDOVÁ LANKA - ТРОСЫ РУЧНОГО ТОРМОЗА**

				OEM REF.	
<b>NISSAN</b>					
Sentra (LH-SX)	09/82=>86	730/1100	<b>07.0054</b>	3653101A01-3653104A01	0,318
Sentra (RH-DX)	09/82=>86	700/900	<b>07.0055</b>	3653001A01-3653004A01	0,287
Sentra 2WD (LH-SX)	86=>91	1225/1450	<b>07.0464</b>	3653150M01-3653160M01	0,635
Sentra 2WD (RH-DX)	86=>91	1280/1455	<b>07.0465</b>	3653050M01-3653060M01 3645150A00	0,672
Almera N15 GA 14DE/16DE-CD20 (RH-DX)	07/95=>	1442/1662	<b>07.0675</b>	365300M010-365301N900	0,724
Almera N15 GA 14DE/16DE-CD20 (LH-SX)	07/95=>	1440/1660	<b>07.0676</b>	365310M010-365311N900	0,702
Almera N15 GA 14DE/16DE-CD20 GX-SLX-S antiskid-SR20DE (RH-DX)	07/95=>	1475/1677	<b>07.0677</b>	365300M810-365300N600	0,761
Almera N15 GA 14DE/16DE-CD20 GX-SLX-S antiskid-SR20DE (LH-SX)	07/95=>	1480/1680	<b>07.0678</b>	365310M810-365310N600	0,775
Almera all (front-avt)	07/95=>	230	<b>07.1535</b>	364024M600	•
Almera all (front-avt)		250	<b>07.1214</b>	3640250J10-3640270J00 3640270J10	0,110
Almera N16 1,5 (RH-DX)	00=>	1440/1610	<b>07.1615</b>	365304M400	0,766
Almera N16 1,5 (LH-SX)	00=>	1430/1605	<b>07.1616</b>	365314M400	•
Almera-Almera Tino (front-avt)	01=>	215	<b>07.1217</b>	36402BM600	0,090
Almera all (RH-DX)	01=>	1465/1640	<b>07.1218</b>	365309M800	0,670
Almera all (LH-SX)	01=>	1450/1630	<b>07.1219</b>	365319M800	•
Almera all (RH-DX)	01=>	1505/1665	<b>07.1220</b>	36530BM700	0,716
Almera ABS (LH-SX)	01=>	1495/1650	<b>07.1221</b>	36531BM700	0,711
Almera Tino (RH-DX)	01=>	1515/1665	<b>07.1222</b>	36530BU000	0,705
Almera Tino (LH-SX)	01=>	1505/1660	<b>07.1223</b>	36531BU000	0,743
Bluebird (LH-SX)	77=>81	565/1210	<b>07.0057</b>	36531Q2104	0,269
Bluebird (RH-DX)	77=>81	460/720	<b>07.0058</b>	36530Q2104	0,246
Bluebird (LH-SX)	80=>84	585/1200	<b>07.0060</b>	36531W1200	0,284
Bluebird (RH-DX)	80=>84	490/750	<b>07.0061</b>	36530W1200	0,293
Bluebird W11 all (RH-DX)	84=>86	1304/1385	<b>07.1224</b>	3653013E02	•
Bluebird W11 all (LH-SX)	84=>86	1068/1460	<b>07.1225</b>	3653113E02	•
Primera W10-W10 Kombi (RH-DX)	07/90=>	1390/1610	<b>07.0892</b>	3653070N00	0,692
Primera W10-W10 Kombi (LH-SX)	07/90=>	1360/1582	<b>07.0893</b>	3653170N00	0,668
Primera W10 Kombi ABS (RH-DX)	07/90=>	1307/1504	<b>07.0894</b>	3653078N00	0,649
Primera W10 Kombi ABS (LH-SX)	07/90=>	1277/1476	<b>07.0895</b>	3653178N00	0,645
Primera (front-avt)	07/90=>	250	<b>07.1214</b>	3640250J10-3640270J00 3640270J10	0,110
Primera P10 1,6-2,0 (drum brake) (RH-DX)	91=>	1395/1605	<b>07.0473</b>	3653070J10	0,580
Primera P10 1,6-2,0 (drum brake) (LH-SX)	91=>	1420/1625	<b>07.0474</b>	3653170J10	0,585
Primera P10 2,0 (disc brake) (RH-DX)	91=>	1315/1490	<b>07.0475</b>	3653071J10	0,559
Primera P10 2,0 (disc brake) (LH-SX)	91=>	1340/1510	<b>07.0476</b>	3653171J10	0,574
Primera P11 all (drum brake) (RH-DX)	06/96=>99	1360/1640	<b>07.0896</b>	365302F000	0,632
Primera P11 all (drum brake) (LH-SX)	06/96=>99	1343/1620	<b>07.0897</b>	365312F000	0,618
Primera P11 all (disc brake) (RH-DX)	06/96=>99	1426/1657	<b>07.0898</b>	365302F200	0,672
Primera P11 all (disc brake) (LH-SX)	06/96=>99	1395/1632	<b>07.0899</b>	365312F200	0,621
Primera P11 all (RH-DX)	06/99=>	1432/1668	<b>07.0900</b>	365309F000	0,676
Primera P11 all (LH-SX)	06/99=>	1405/1642	<b>07.0901</b>	365319F000	0,641
Primera P11 (front-avt)	01=>	295	<b>07.1226</b>	364022F000	0,103
Primera P11 (RH-DX)	01=>	1440/1665	<b>07.1227</b>	365309F500	0,653
Primera P11 (LH-SX)	01=>	1415/1625	<b>07.1228</b>	365319F500	0,605
Primera P12 (LH-SX)	03=>	1628/1778	<b>07.1618</b>	36531AV600-36531AV601 36531BA00B	0,795

**COMANDI FLESSIBILI FUNE FRENO A MANO - BRAKE CABLES - CABLES DE FREIN  
BREMSSEILE - CABLES DE FRENO - CABOS DE TRAVAO  
LINKI HAMULCA - BRZDOVÁ LANKA - ТРОСЫ РУЧНОГО ТОРМОЗА**

				OEM REF.	
<b>NISSAN</b>					
Primera P12 (RH-DX)	03=>	1628/1778	<b>07.1617</b>	36530AV600-36530AV601 36530BA00B	•
Primera P12 all (front-avt)	04=>	230	<b>07.1535</b>	364024M600	•
Maxima all (LH-SX)	10/00=>03	1466/1703	<b>07.1960</b>	365312Y00	•
Maxima all (RH-DX)	10/00=>03	1473/1703	<b>07.1961</b>	365302Y00	•
QX all (LH-SX)	10/00=>03	1466/1703	<b>07.1960</b>	365312Y00	•
QX all (RH-DX)	10/00=>03	1473/1703	<b>07.1961</b>	365302Y00	•
Note all (front-avt)	06=>	200	<b>07.1402</b>	36402AX000	0,095
Note all (LH-SX)	06=>	1494/1706	<b>07.1741</b>	365319U00A	0,611
Note all (RH-DX)	06=>	1555/1770	<b>07.1742</b>	365309U00A	0,634
Serena 1,6-D (LH-SX)	93=>	960/1235	<b>07.0478</b>	365319C005	0,505
Serena 1,6-D (RH-DX)	93=>	1335/1610	<b>07.0479</b>	365309C005	0,592
Serena 2,0 (LH-SX)	93=>	1325/1600	<b>07.0480</b>	365319C104	0,476
Serena 2,0 (RH-DX)	93=>	1365/1635	<b>07.0481</b>	365309C104	•
Serena LD23 1,6 (RH-DX)	94=>98	1355/1600	<b>07.1534</b>	365309C006	0,558
300 ZX (RH-DX)	84=>89	696/1033	<b>07.1230</b>	3653002P02	•
300 ZX (LH-SX)	84=>89	727/977	<b>07.1231</b>	3653102P02	•
Cube all (RH-DX)	09=>	1569/1723	<b>07.1969</b>	365301FE0A	0,693
Cube all (LH-SX)	09=>	1485/1640	<b>07.1970</b>	365311FE0A	0,669
Qashqai all (front-avt)	04/07=>	262	<b>07.1962</b>	36402JD00A	0,093
Qashqai all (5 seats) (LH-SX)	04/07=>	1523/1703	<b>07.1963</b>	36531JD00A	0,808
Qashqai all (5 seats) (RH-DX)	04/07=>	1524/1705	<b>07.1964</b>	36530JD00A	0,805
Qashqai +2 all (7 seats) (LH-SX)	04/07=>	1647/1833	<b>07.1965</b>	36531EY10A	0,840
Qashqai +2 all (7 seats) (RH-DX)	04/07=>	1647/1835	<b>07.1966</b>	36530EY10A	0,830
Juke 1,6-1,5Dci (RH-DX)	10=>	1632/1700	<b>07.2010</b>	365301KK0A	•
Juke 1,6-1,5Dci (LH-SX)	10=>	1505/1672	<b>07.2011</b>	365311KK0A	•
Juke 1,6-1,5Dci (front-avt)	06/10=>	220	<b>07.2038</b>	364021KA0A	•
Terrano II R20 SWB (LH-SX)	93=>	1115/1325	<b>07.0680</b>	365310F000-365310F001	0,497
Terrano II R20 SWB (RH-DX)	93=>	1150/1355	<b>07.0681</b>	365300F000-365300F001	0,502
Terrano II R20 LWB (LH-SX)	93=>	1265/1470	<b>07.0682</b>	365310F600-365310F601	0,529
Terrano II R20 LWB (RH-DX)	93=>	1270/1480	<b>07.0683</b>	365300F600-365300F601	0,528
Terrano II LWB (RH-DX)	99=>	1275/1520	<b>07.2039</b>	365300X900-365302X801 365302X90A	•
Terrano II LWB (LH-SX)	99=>	1268/1510	<b>07.2040</b>	365310X900-365312X801 365312X90A	•
Terrano II SWB (RH-DX)	99=>	1150/1395	<b>07.2041</b>	365300X800	•
Terrano II SWB (LH-SX)	99=>	1120/1365	<b>07.2042</b>	365310X800-365312X80A	•
Patrol (RH-DX)		1015/1150	<b>07.0300</b>	36402G9501-36402G9701	0,405
Patrol (LH-SX)		915/1050	<b>07.0301</b>	36402G9601	0,368
Patrol (RH-DX)		790/925	<b>07.0302</b>	36402G9600-36402G9700	0,323
Patrol (LH-SX)		835/975	<b>07.0303</b>	36402G9604	0,370

**COMANDI FLESSIBILI FUNE FRENO A MANO - BRAKE CABLES - CABLES DE FREIN  
BREMSSEILE - CABLES DE FRENO - CABOS DE TRAVAO  
LINKI HAMULCA - BRZDOVÁ LANKA - ТРОСЫ РУЧНОГО ТОРМОЗА**





				OEM REF.	
<b>NISSAN</b>					
X-Trail (T30) all (RH-DX)	03=>	1555/1770	<b>07.1619</b>	365308H300	•
X-Trail (T30) all (LH-SX)	03=>	1608/1745	<b>07.1620</b>	365318H300	•
X-Trail all (front-avt)	08=>	305	<b>07.2043</b>	36402JG00A	•
Navara D22 all (LH-SX)	08=>	1505/2250	<b>07.1873</b>	36531VK000-36531VK00A	•
Navara D22 all (RH-DX)	08=>	1446/1730	<b>07.1874</b>	36530VK000-36530VK00A	•
NP300 all (LH-SX)	08=>	1505/2250	<b>07.1873</b>	36531VK000-36531VK00A	•
NP300 all (RH-DX)	08=>	1446/1730	<b>07.1874</b>	36530VK000-36530VK00A	•
D21 king cab. 2WD (reg. body) KCTD25-Z20-SD23-KA24E-TD25-Z20S (LH-SX)	88=>04/92	1488/2323	<b>07.0684</b>	3653108G10	0,113
D21 king cab. 2WD (reg. body) KCTD25-Z20-SD23-KA24E-TD25-Z20S (RH-DX)	88=>04/92	1194/2026	<b>07.0685</b>	3653008G10-365308B010	•
B120 Pick-Up/Sunny (front-avt)	71=>	325/582	<b>07.1529</b>	36402G1000	•
B120 Pick-Up/Sunny	71=>	532/1540	<b>07.1530</b>	36400G1400	•
620 Pick-Up (LH-SX)	=>77	935/1500	<b>07.1532</b>	36510B5300	•
620 Pick-Up (RH-DX)	=>77	937/1643	<b>07.1533</b>	36500B5300	•
620 Pick-Up (front-avt)	=>79	1381/1828	<b>07.1531</b>	36400B5200	•
G720 Pick-Up 2WD reg.cab. (LH-SX)	09/79=>86	749/1244	<b>07.0484</b>	3653104W00	•
G720 Pick-Up 2WD reg.cab. (RH-DX)	09/79=>86	984/1451	<b>07.0485</b>	3653004W00	•
G720 Pick-Up 2WD king.cab. (LH-SX)	09/79	986/1475	<b>07.0486</b>	3653104W10	•
G720 Pick-Up 2WD king.cab. (RH-DX)	09/79	1214/1685	<b>07.0487</b>	3653004W10	•
G720 Pick-Up 4WD (RH-DX)	80=>82	1396/1772	<b>07.0488</b>	3653044W10	•
G720 Pick-Up 4WD (RH-DX)	82=>84	1152/1510	<b>07.0489</b>	3653044W00	•
E20 1,8-2,0 Wagon L18/H20 eng. (front-avt)		2104/2518	<b>07.0490</b>	36401B8400	•
 					
<b>NISSAN - Commercial Vehicle</b>					
Kubistar all (capacity 600 kg) (LH-SX)	97=>	1075/1415	<b>07.0712</b>	7700311698	0,387
Kubistar all (capacity 600 kg) (RH-DX)	97=>	1085/1420	<b>07.0713</b>	7700311699	0,404
Kubistar all (capacity 800 kg) (LH-SX)	97=>	1070/1430	<b>07.0714</b>	7700311700	0,407
Kubistar all (capacity 800 kg) (RH-DX)	97=>	1080/1440	<b>07.0715</b>	7700311701	0,422
Vanette (front-avt)	87=>92	2610/2775	<b>07.0062</b>	36402Y9503	•
Vanette (front-avt)	87=>92	2120/2285	<b>07.0063</b>	36402Y9504	0,692
Vanette	87=>92	1875	<b>07.0679</b>	36400Y9503	0,774
Interstar 2,5 D-2,8 Dti (front-avt)	10/97=>	945/1175	<b>07.0716</b>	3640200QAA-7700311216	0,395
Interstar 2,5 D-2,8 Dti SWB (LH/RH-SX/DX)	10/97=>	1048/1420	<b>07.0717</b>	3640000QAA-7700311217	0,358
Interstar 2,5 D-2,8 Dti LWB (LH/RH-SX/DX)	10/97=>	1439/1737	<b>07.0976</b>	3640000QAD-8200021940	0,555
Primastar all (front-avt)	01=>	256/508	<b>07.0916</b>	3640200QAB-7700312835	0,120
Primastar all SWB (interm.)	01=>	1185	<b>07.0917</b>	3651800QAA-7700313058	0,126

**COMANDI FLESSIBILI FUNE FRENO A MANO - BRAKE CABLES - CABLES DE FREIN  
BREMSSEILE - CABLES DE FRENO - CABOS DE TRAVAO  
LINKI HAMULCA - BRZDOVÁ LANKA - ТРОСЫ РУЧНОГО ТОРМОЗА**





				OEM REF.	
<b>NISSAN - Commercial Vehicle</b>					
Primastar all LWB (interm.)	01=>	1585	<b>07.0918</b>	3651800QAB-3651800QAC 91165522-8200008473	0,141
Primastar all (RH-DX)	01=>	1365/1503	<b>07.0919</b>	3653000QAC-8200178389	0,467
Primastar all (LH-SX)	01=>	1465/1603	<b>07.0920</b>	3653100QAC-8200178390	0,495
Primastar all (RH-DX)	03=>	1365/1496	<b>07.1428</b>	3653000QAD-7700312837 8200263819	0,516
Primastar all (LH-SX)	03=>	1465/1596	<b>07.1429</b>	3653100QAD-7700312836 8200263821	0,542
Primastar all (front-avt)	11=>	260/498	<b>07.1971</b>	365301862R	0,123
Primastar all LWB (interm.)	11=>	1643	<b>07.1972</b>	365301796R	0,171
Primastar all SWB (interm.)	11=>	1245	<b>07.1973</b>	365301673R	0,155
Cabstar F23 LWB (RH-DX)	01=>	900/1292	<b>07.2012</b>	36530F3903	•
Cabstar F23 LWB (LH-SX)	01=>	904/2110	<b>07.2013</b>	36531F3903	•
Cabstar F24 all (RH-DX)	10/00=>08/07	910/1130	<b>07.2044</b>	364529X502-364529X50A	•
Cabstar F24 all (LH-SX)	10/00=>08/07	1050/1270	<b>07.2045</b>	364529X503-364529X50B	•

<b>OPEL</b>					
Corsa all (LH-SX)	11/82=>	375/820	<b>07.860</b>	522548-90125513	0,227
Corsa all (RH-DX)	11/82=>	370+730/ 1440	<b>07.861</b>	522549-90125512	0,470
Corsa all (LH-SX)	85=>	970	<b>07.862</b>	522571-90193039	0,079
Corsa all (RH-DX)	85=>	765/1415	<b>07.863</b>	522572-90223404	0,334
Corsa all (ch. CN4052761-) (LH-SX)	91=>92	660/1260	<b>07.917</b>	522593-90373926	0,311
Corsa all (ch. CN4052761-) (RH-DX)	91=>92	1040	<b>07.927</b>	522594	0,084
Corsa B all (LH-SX)	93=>	750/1375	<b>07.929</b>	522615-90445985-522643 90538700	0,328
Corsa B all (RH-DX)	93=>	1080	<b>07.930</b>	522614-90445986-522642 90538699	0,085
Corsa C (exc. Sport-Gsi) (front-avt)	01=>	330	<b>07.0902</b>	522445-9127187	0,041
Corsa C (drum brake) (RH-DX)	01=>	832	<b>07.0903</b>	522449-90576454	0,054
Corsa C (drum brake) (LH-SX)	01=>	763/1095	<b>07.0904</b>	522448-90576453	0,301
Corsa C (drum brake) (LH-SX)	01=>	763/1106	<b>07.0905</b>	522655-24443834	0,313
Corsa C (disc brake) (RH-DX)	01=>	370/1143	<b>07.0906</b>	522446-9191574	0,230
Corsa C (disc brake) (LH-SX)	01=>	365+760/ 1425	<b>07.0907</b>	522447-9191578	0,449
Corsa C all (drum brake) (RH-DX)	01=>	220	<b>07.1235</b>	522151-522152-93170227 93170228	0,042
Corsa C all (LH-SX)	04=>	307+756/ 1426	<b>07.1537</b>	522015-13138929	0,443
Corsa C all (RH-DX)	04=>	307/1143	<b>07.1538</b>	522014-13138930	0,189
Corsa D 1,0-1,2 (3 doors)	06=>	1245/1460+ 1260/1476	<b>07.1886</b>	522040-13214179	1,017
Corsa D 1,4-1,3 Td (5 doors)	06=>	1242/1477+ 1255/1492	<b>07.1887</b>	522039-13214178	1,016
Corsa D 1,7 Td-1,6	06=>	1292/1463+ 1307/1475	<b>07.1934</b>	522038-13214177	1,026
Corsa D 1,3 CTDi-1,4 (5 doors)	07=>	1255/1485+ 1240/1470	<b>07.1797</b>	522043-13255756	1,025
Corsa D 1,7 Td-Z 1,6	07=>	1295/1455+ 1305/1470	<b>07.1907</b>	522042-13255755	•
Corsa D 1,0-1,2 (3 doors)	07=>	1245/1460+ 1260/1470	<b>07.1908</b>	522044-13255757	•
Tigra all (LH-SX)	93=>	750/1375	<b>07.929</b>	522615-90445985-522643 90538700	0,328
Tigra all (RH-DX)	93=>	1080	<b>07.930</b>	522614-90445986-522642 90538699	0,085





**COMANDI FLESSIBILI FUNE FRENO A MANO - BRAKE CABLES - CABLES DE FREIN  
BREMSSEILE - CABLES DE FRENO - CABOS DE TRAVAO  
LINKI HAMULCA - BRZDOVÁ LANKA - ТРОСЫ РУЧНОГО ТОРМОЗА**

				OEM REF.	
<b>OPEL</b>					
Tigra all (LH-SX)	04=>	307+756/ 1426	<b>07.1537</b>	522015-13138929	0,443
Tigra all (RH-DX)	04=>	307/1143	<b>07.1538</b>	522014-13138930	0,189
Agila all ABS (LH-SX)	=>00	1302/1516	<b>07.1038</b>	4705708-9210314	0,667
Agila all ABS (LH-SX)	=>00	1300/1510	<b>07.1040</b>	4700358	0,654
Agila all ABS (RH-DX)	=>00	1291/1507	<b>07.1039</b>	4700357-9203995	0,502
Agila all no ABS (RH-DX)	01=>02	1285/1498	<b>07.1037</b>	4705707-9210312	0,578
Agila all no ABS (LH-SX)	01=>02	1302/1516	<b>07.1038</b>	4705708-9210314	0,667
Agila all (LH-SX)	03=>	1290/1530	<b>07.1236</b>	4706689-9211156	0,683
Agila all (RH-DX)	03=>	1281/1530	<b>07.1237</b>	4706688-9211155	0,563
Agila all (LH-SX)	09=>	1380/1600	<b>07.1875</b>	4709863-93195341	0,677
Agila all (RH-DX)	09=>	1385/1600	<b>07.1876</b>	4709864-93195342	0,677
Kadett B	=>71	2570	<b>07.392</b>	522507	0,155
Kadett B	71=>	2575	<b>07.601</b>	522522	0,190
Kadett C 1,0-1,2	73=>	2445	<b>07.394</b>	522525	0,150
Kadett C 1,6-1,9-2,0	74=>	2460	<b>07.393</b>	522526	0,152
Kadett D	09/79=>	800+990/ 2880	<b>07.827</b>	522539-522553	0,757
Kadett D Diesel/Caravan	09/79=>	785+885/ 2760	<b>07.806</b>	522543-522547-522560-522561 90184271-90193357	0,755
Kadett D/Caravan	83=>	750+750/ 2755	<b>07.1935</b>	522556	0,889
Kadett E Combi	84=>	1230+1400/ 3130	<b>07.231</b>	522573-90216441	0,965
Kadett E 1,2-1,3-1,6-1,8-D/Caravan 1,3-1,6	84=>	785+885/ 2760	<b>07.806</b>	522543-522547-522560-522561 90184271-90193357	0,755
Kadett E 1,2-1,3 (2 doors)	84=>85	900+950/ 2835	<b>07.805</b>	522559-90184270	0,760
Kadett E all	86=>	700/1270+ 1100/1675	<b>07.023</b>	522568-90235948-90369708	0,875
Kadett E/Caravan	87=>	720/1290+ 830/1400	<b>07.024</b>	522580-522600-522640 90335899-90538629	0,774
Kadett E/Caravan (carico rinforzato)	87=>	720/1280+ 820/1395	<b>07.644</b>	522579-90335900	0,765
Kadett E 2,0 Gsi	87=>	700/1175+ 1100/1575	<b>07.025</b>	522577-90279542-522532 90373855	0,815
Astra all	92=>	700/1275+ 1100/1690	<b>07.444</b>	522603-90373923-522641 90538698	0,874
Astra SW all	92=>	720/1290+ 830/1400	<b>07.024</b>	522600-522640-90538629	0,774
Astra SW 2,0 (5 doors)	94=>	720/1170+ 830/1280	<b>07.0535</b>	522628-90496316	0,726
Astra 2,0 GSi-Cabrio	87=>	700/1175+ 1100/1575	<b>07.025</b>	522577-90279542-522532 90373855	0,815
Astra all (front-avt)	98=>	311	<b>07.0687</b>	522551-9127937	0,073
Astra G all (drum brake)	98=>	182	<b>07.0689</b>	522654-522005-9127527 18045189	0,042
Astra all (disc brake)	98=>	1400/1590+ 1400/1590	<b>07.0690</b>	522001-9223129	1,533
Astra all (drum brake)	98=>01	1060+1060/ 1252	<b>07.0688</b>	522650-9127787	0,915
Astra G all (drum brake)	98=>01	182	<b>07.1242</b>	522653-9127518	0,035
Astra G (front-avt)	98=>05	305	<b>07.2016</b>	522550-9127540	•
Astra G all (disc brake)	99=>	1495+1495/ 1680	<b>07.0912</b>	522004-24425112	1,556
Astra G all (disc brake)	00=>	1400/1590+ 1400/1590	<b>07.0908</b>	522003-522440-522651-9217791 24425108	1,437





**COMANDI FLESSIBILI FUNE FRENO A MANO - BRAKE CABLES - CABLES DE FREIN  
BREMSSEILE - CABLES DE FRENO - CABOS DE TRAVAO  
LINKI HAMULCA - BRZDOVÁ LANKA - ТРОСЫ РУЧНОГО ТОРМОЗА**

				OEM REF.	
<b>OPEL</b>					
Astra G all (drum brake)	00=>	1060+1060/ 1254	<b>07.1238</b>	522656-24436451	0,936
Astra G all (disc brake)	02=>	1403+1403/ 1592	<b>07.1239</b>	522007-522528-24465148	1,316
Astra G all (disc brake)	02=>	1495+1680/ 1495+1680	<b>07.1247</b>	522008-522529-13104993	1,372
Astra G all (disc brake)	04=>	1400+1400/ 1587	<b>07.1240</b>	522453-13153654	1,171
Astra H all (drum brake)	04=>	182	<b>07.0689</b>	522654-522005-9127527	0,042
Astra H all (drum brake)	04=>	1085/1295+ 1115/1325	<b>07.1241</b>	522455-522031-13157061	0,995
Astra H all (exc.SW) (disc brake)	04=>	1460/1640+ 1480/1660	<b>07.1243</b>	522456-522029-13157062	1,303
Astra H SW (disc brake)	04=>	1550/1730+ 1580/1760	<b>07.1244</b>	522027-522030-13157063	1,406
Astra H all (drum brake)	09/08=>10	185	<b>07.1978</b>	522041-93189991	•
Astra (2010) all mod. (mec. brake) (LH/RH-SX/DX)	10=>	1678/1806	<b>07.1974</b>	522063-13328132	•
Astra (2012) all (mec. brake) (LH-SX)	10=>	1685/1815	<b>07.1976</b>	522097-13367627	•
Astra (2012) all (mec. brake) (RH-DX)	10=>	1685/1815	<b>07.1977</b>	522098-13367628	•
Zafira all (front-avt)	98=>	311	<b>07.0687</b>	522551-9127937	0,073
Zafira all (disc brake)	98=>	1400/1590+ 1400/1590	<b>07.0690</b>	522001-9223129	1,533
Zafira all (drum brake)	98=>	182	<b>07.0689</b>	522654-522005-9127527 18045189	0,042
Zafira all (drum brake)	98=>01	1060+1060/ 1252	<b>07.0688</b>	522650-522656-24436451 9127787	0,915
Zafira all (drum brake)	98=>01	182	<b>07.1242</b>	522653-9127518	0,035
Zafira A (front-avt)	98=>05	305	<b>07.2016</b>	522550-9127540	•
Zafira 1,6-1,8-2,0 16v (disc brake)	04/99=>06/05	1495+1495/ 1680	<b>07.1249</b>	522002-9223133	1,503
Zafira (Bosh) (disc brake)	00=>	1400/1590+ 1400/1590	<b>07.0908</b>	522003-522440-522651-9217791 24425108	1,437
Zafira 1,6-1,8 all (drum brake)	01=>	1157+1157/ 1355	<b>07.0911</b>	522558-90581267	0,975
Zafira 1.8-2.0-2.0Dti all (disc brake)	01=>	1495+1495/ 1680	<b>07.0912</b>	522004-24425112-9036102	1,556
Zafira 1.8-2.0-2.0Dti all (disc brake)	02=>	1495+1680/ 1495+1680	<b>07.1247</b>	522008-522529	1,372
Zafira 1,6-2,0-2,0/2,2 Dti (disc brake)	04=>	1495+1495/ 1677	<b>07.1248</b>	522454-13153656	1,358
Zafira 1,6-2,0-2,0/2,2 Dti (disc brake)	04=>	1495+1495/ 1677	<b>07.1406</b>	522032-13153655	1,223
Zafira 1,6-2,0-2,0/2,2 Dti (disc brake)	06=>	1551/1749+ 1577/1774	<b>07.1622</b>	522028-522036-13157064 13237275	1,376
Zafira B 1,6-2,0 (gas mod.) (disc brake)	06=>10	1575/1770+ 1575/1770	<b>07.2037</b>	522037-522052-522071 13340399-13321652-13239691	•
Zafira C (P12) all (manual brake) (LH-SX)	10/11=>	1760/1890	<b>07.1979</b>	522099-13367629	•
Zafira C (P12) all (manual brake) (RH-DX)	10/11=>	1760/1890	<b>07.1980</b>	522100-13367630	•
Meriva	=>03	1440/1610+ 1440/1610	<b>07.1245</b>	522012-93318894	1,276
Meriva	04=>	1440/1615+ 1440/1615	<b>07.1246</b>	522016-13159021	1,266
Sintra all (front-avt)	97=>	2392/2583	<b>07.0913</b>	522432-10405685	0,835
Sintra 2,2-2,2 Td-3,0 all (RH-DX)	97=>	485/710	<b>07.0914</b>	522430-522574-10408912	0,292
Sintra 2,2-2,2 Td-3,0 all (LH-SX)	97=>	485/800	<b>07.0915</b>	522431-10403823	0,300
Ascona A	70=>	875+875/ 2545	<b>07.487</b>	522515-522519	0,799
Ascona B	76=>	2675	<b>07.610</b>	522555	0,159
Ascona C all (LH-SX)	09/81=>	290/865	<b>07.828</b>	522545	0,209

**COMANDI FLESSIBILI FUNE FRENO A MANO - BRAKE CABLES - CABLES DE FREIN  
BREMSSEILE - CABLES DE FRENO - CABOS DE TRAVAO  
LINKI HAMULCA - BRZDOVÁ LANKA - ТРОСЫ РУЧНОГО ТОРМОЗА**

				OEM REF.	
<b>OPEL</b>					
Ascona C all (RH-DX)	09/81=>	290+1190/ 2035	<b>07.829</b>	522546	0,600
Ascona C all (LH-SX)	83=>	870	<b>07.675</b>	522562-90170751	0,090
Ascona C all (RH-DX)	83=>	1200/2040	<b>07.641</b>	522552-90170750	0,484
Ascona C all (LH-SX)	86=>	760	<b>07.712</b>	522569-522590-90344899	0,081
Ascona C all (RH-DX)	86=>	1050/2035	<b>07.709</b>	522570-90189718	0,434
Manta	70=>	875+875/ 2545	<b>07.487</b>	522515-522519	0,799
Manta	76=>	2675	<b>07.610</b>	522555	0,159
Cavalier	76=>	2675	<b>07.610</b>	522555	0,159
Cavalier (RH-DX)	09/81=>	290+1190/ 2035	<b>07.829</b>	522546	0,600
Cavalier (LH-SX)		870	<b>07.675</b>	522562-90170751	0,090
Cavalier (RH-DX)		1200/2040	<b>07.641</b>	522552-90170750	0,484
Cavalier (RH-DX)		1050/2035	<b>07.709</b>	522570-90189718	0,434
Vectra 2,0 all (RH-DX)	88=>	1060/2005	<b>07.678</b>	522582-522598-90375404	0,447
Vectra 1,4-1,6-1,8-1,7D (-ch. K1055983) (LH-SX)	88=>89	760	<b>07.712</b>	522569-522590-90344899	0,081
Vectra 1,4-1,6-1,8-1,7D (-ch. K1055983) (RH-DX)	88=>89	1070/2100	<b>07.711</b>	522588-522583-90344447	0,449
Vectra 2,0 (-ch. 1055983) (LH-SX)	88=>89	665	<b>07.935</b>	522581-90297927	0,071
Vectra 1,4-1,6-1,8-1,7D (ch. K1055984-) (LH-SX)	89=>	755	<b>07.026</b>	522597-522601-90421703	0,082
Vectra 2,0 (ch. 1055984-) (LH-SX)	89=>	665	<b>07.936</b>	522589-522599-90375403	0,067
Vectra 2,0 all (RH-DX)	89=>	1070/2020	<b>07.0263</b>	522621-90495224	0,461
Vectra 4x4 (-ch. 1092928)/Calibra all	89=>	950/1350+ 1110/1500	<b>07.027</b>	522585-90334462	0,904
Vectra 1,4-1,6-1,8-1,7 D (ch. K1055984-) (RH-DX)	89=>90	1030/2080	<b>07.446</b>	522596-522602-90421704	0,460
Vectra 4x4 (ch. 1092929-)/Calibra all	90=>	965/1365+ 1110/1500	<b>07.447</b>	522595-90374902	0,968
Vectra 1,4-1,6-1,8-1,7D (RH-DX)	90=>	1070/2120	<b>07.0691</b>	522620-90334824-90495223	0,437
Vectra all (front-avt)	09/95=>	315	<b>07.0692</b>	522409-90495463	0,049
Vectra all	9/95=>	1275/1455+ 1275/1455	<b>07.0694</b>	522412-522524-90468900	1,199
Vectra 1,6 (drum brake)	09/95=>	210	<b>07.0695</b>	522411-522414-90496486 90538631	0,044
Vectra 1,8-2,0 all (disc brake)	09/95=>	130	<b>07.0696</b>	522410-90496487	0,047
Vectra 2,0 Td (drum brake) (LH/RH-SX/DX)	95=>02	218	<b>07.1539</b>	522417-90575127	0,043
Vectra all (front-avt)	98=>	311	<b>07.0687</b>	522551-9127937	0,073
Vectra all	02=>	1397/1578+ 1454/1630	<b>07.0910</b>	522452-24455114-522451 9191216	1,234
Vectra SW-Caravan D/Bz	02=>04	1633+1633/ 1805	<b>07.1250</b>	522025-522026-13162335 13162337-522009-522011 522020-522021-522024 13106485-93181109-93181110	1,391
Signum	04=>	1633+1633/ 1805	<b>07.1250</b>	522025-522026-13162335 13162337-522009-522011 522020-522021-522024 13106485-93181109-93181110	1,391
Insignia/Insignia Tourer (mecc. brake) (LH/RH-SX/DX)	10=>	1800/1940	<b>07.2014</b>	522047-522057-13250177 13323804	•
Insignia all 4WD (mecc. brake)	10=>	1852/2005	<b>07.2015</b>	522046-13227133	•
Rekord C	67=>	815+815/ 2650	<b>07.398</b>	522200	0,693

**COMANDI FLESSIBILI FUNE FRENO A MANO - BRAKE CABLES - CABLES DE FREIN  
BREMSSEILE - CABLES DE FRENO - CABOS DE TRAVAO  
LINKI HAMULCA - BRZDOVÁ LANKA - ТРОСЫ РУЧНОГО ТОРМОЗА**

				OEM REF.	
<b>OPEL</b>					
Rekord C	71=>	830+830/ 2660	<b>07.399</b>	522201	0,753
Rekord D	72=>	1045+1045/ 3255	<b>07.400</b>	522202	•
Rekord D Caravan	75=>	960+970/ 2370	<b>07.603</b>	522531	0,928
Rekord E all	77=>	1000+1000/ 2990	<b>07.714</b>	522537-522554-90095420	0,870
Rekord E/Carlton 2,0	77=>	990+1045/ 2990	<b>07.859</b>	522544-90063457	0,934
Commodore B 2,8	75=>	960+970/ 2370	<b>07.603</b>	522531	0,928
Commodore C	77=>	1000+1000/ 2990	<b>07.714</b>	522537-522554-90095420	0,870
Commodore C	78=>	1050+1050/ 3000	<b>07.686</b>	522542-90112381	•
Senator/Monza	78=>	905+970/ 2920	<b>07.188</b>	522535-90079050	0,879
Senator/Monza (-ch. 9100034)	80=>	905+905/ 2935	<b>07.182</b>	522538-90112028	0,842
Senator B	87=>	825/1515+ 850/1545	<b>07.257</b>	522575-90222437	0,830
Omega	87=>	825/1515+ 850/1545	<b>07.257</b>	522575-90222437	0,830
Omega	88=>	855/1550+ 855/1550	<b>07.258</b>	522592-522578-90335547 90374841-522527-24404062	0,860
Frontera (2 doors) (-ch. SV720102) (RH-DX)	92=>95	1258/1665	<b>07.1798</b>	522616-91144424	0,477
Frontera (2 doors) (-ch. SV720102) (LH-SX)	92=>95	1310/1719	<b>07.1799</b>	522617-91144425	0,498
Frontera UD2 (2 doors) (RH-DX)	99=>	1315/1500	<b>07.1252</b>	522424-91152686	0,635
Frontera UD2 (2 doors) (LH-SX)	99=>	1315/1500	<b>07.1253</b>	522425-91152687	0,639
Frontera WL4 (4 doors) (RH-DX)	99=>	1315/1936	<b>07.1254</b>	522426-91152688	0,659
Frontera WL4 (4 doors) (LH-SX)	99=>	1315/1936	<b>07.1255</b>	522427-91152689	•
Frontera (4 doors) (-ch. SV720102) (RH-DX)	03=>	1260/2100	<b>07.1842</b>	522611-91143475	0,617
Frontera (4 doors) (-ch. SV720102) (LH-SX)	03=>	1315/2160	<b>07.1843</b>	522610-91143474	0,531
					
<b>OPEL - Commercial Vehicle</b>					
Corsa Combo	94=>	1175/1520+ 1315/1660	<b>07.0536</b>	522618-90447335	1,044
Corsa C Combo all (drum brake)	01=>	1040+1040/ 1235	<b>07.1234</b>	522450-522150-24468130 9225541	0,912
Corsa C Combo (front-avt)	01=>	445	<b>07.1407</b>	522013-9225545	0,054
Corsa C Combo (disc brake)	01=>	1407+1407/ 1582	<b>07.1408</b>	522017-13172730	1,176
Movano (front-avt)	00=>	946/1175	<b>07.0716</b>	4403487-4500250-9160550 9111487	0,395
Movano (LH/RH-SX/DX)	00=>	1048/1420	<b>07.0717</b>	4500251-9160551	0,358
Movano (LH/RH-SX/DX)	00=>	1440/1735	<b>07.0976</b>	9111490-4403490-8200021940 3640000QAD	0,555
Campo all 2WD (interm.)	88=>06/99	1795/1845	<b>07.1380</b>	522619-94367286	•
Campo all 4WD (interm.)	88=>06/99	1325/1380	<b>07.1381</b>	4303489-94367287	•

**COMANDI FLESSIBILI FUNE FRENO A MANO - BRAKE CABLES - CABLES DE FREIN  
BREMSEILE - CABLES DE FRENO - CABOS DE TRAVAO  
LINKI HAMULCA - BRZDOVÁ LANKA - ТРОСЫ РУЧНОГО ТОРМОЗА**

				<b>OEM REF.</b>	
---	---	---	--	-----------------	---





**OPEL - Commercial Vehicle**

Campo all 2WD (RH-DX)	07/99=>	1700/1872	<b>07.1382</b>	522520-97174665	•
Campo all 2WD (LH-SX)	07/99=>	1640/1812	<b>07.1383</b>	522523-97217149	•
Campo all 4WD (RH-DX)	07/99=>	1700/1858	<b>07.1384</b>	522428-97111565	0,784
Campo all 4WD (LH-SX)	07/99=>	1630/1798	<b>07.1385</b>	522429-97111566	•
<b>Vivaro (front-avt)</b>	01=>	502	<b>07.0916</b>	91166639-4408726	0,120
Vivaro (interm.)	01=>	1185	<b>07.0917</b>	91165521-4408735	0,126
Vivaro (interm.)	01=>	1585	<b>07.0918</b>	91165522-4408730	0,141
Vivaro (RH-DX)	01=>	1365/1495	<b>07.0919</b>	91168672-4408727	0,467
Vivaro (LH-SX)	01=>	1465/1590	<b>07.0920</b>	91168673-4408734	0,495
Vivaro all (RHD mod.) (front-avt)	01=>	355/600	<b>07.1427</b>	820008472-91166640	0,151
Vivaro all Cab. mod. (interm.)	01=>	1880	<b>07.2046</b>	4413816-93852378	•
Vivaro all (RH-DX)	03=>	1365/1496	<b>07.1428</b>	4414821-93852188-8200263819	0,516
Vivaro all (LH-SX)	03=>	1465/1596	<b>07.1429</b>	4414822-93852189-8200263821	0,542
Vivaro all (front-avt)	11=>	260/498	<b>07.1971</b>	4421102-93864841	0,123
Vivaro all LWB (interm.)	11=>	1643	<b>07.1972</b>	4420801-93864842	0,171
Vivaro all SWB (interm.)	11=>	1245	<b>07.1973</b>	4420800-93864840	0,155
Vivaro all Cab. mod. (interm.)	11=>	1942	<b>07.1983</b>	4421104-93864843	0,183
Vivaro all LWB (KIT)	11=>	495+1645/ 260	<b>07.2017</b>	1605112	•
Vivaro all SWB (KIT)	11=>	495+1245/ 260	<b>07.2018</b>	1605111-93168971	•
Bedford CF SWB (LH/RH-SX/DX)	71=>	900/1155	<b>07.992</b>	8829951-91106936	0,315
Bedford CF LWB (LH/RH-SX/DX)	71=>	900/1835	<b>07.064</b>	8829950-91106935	0,336
Bedford CF2 (LH/RH-SX/DX)	83=>	870/1125	<b>07.0557</b>	91106934	•
Bedford CF2 LWB (LH/RH-SX/DX)	83=>	875/1820	<b>07.228</b>	522564-91106933	0,327
Bedford Midi all (LH-SX)	85=>	335	<b>07.028</b>	94233607	0,088
Bedford Midi all (RH-DX)	85=>	925	<b>07.029</b>	94233606	0,122
Bedford Midi all	85=>	2200/2655	<b>07.030</b>	94226685	0,781
Bedford Midi mod. 80 (LH/RH-SX/DX)	85=>	549/900	<b>07.543</b>	91123067-91139077	•
Bedford Midi all (front-avt)	85=>	2165/2624	<b>07.1536</b>	91133434	0,700
Bedford Rascal	86=>	840+800/ 1965	<b>07.031</b>	91112648	0,682
Bedford Rascal	86=>	574+809/ 1812	<b>07.542</b>	91122085	•





**PEUGEOT**

104 all (LH/RH-SX/DX)		810/1450	<b>07.766</b>	474539-474551-474541	0,314
104 ZS-Coupé (LH/RH-SX/DX)	=>83	700/1255	<b>07.921</b>	474540	0,290
106 all (LH/RH-SX/DX)	91=>	1100/1290	<b>07.448</b>	474589	0,393
106 all (drum brake) (LH/RH-SX/DX)	96=>	1125/1445	<b>07.0112</b>	4745H7-4745J1-4575T4	0,344
106 all (disc brake) (LH/RH-SX/DX)	96=>	1235/1050	<b>07.0113</b>	4745H8-96263856	0,421
107 all (LH-SX)	05=>	1243/1486	<b>07.1338</b>	4745Y3	0,536
107 all (RH-DX)	05=>	1235/1478	<b>07.1454</b>	4745Y2	0,544
204 (LH-SX)	=>69	515/750	<b>07.566</b>	483436-483439	0,177
204 (RH-DX)	=>69	585/945	<b>07.564</b>	483415	•
204 all (LH/RH-SX/DX)	70=>	920/1555	<b>07.718</b>	483440-483466	0,363
205 all (exc. GTI) (LH-SX)	83=>	1120/1410	<b>07.962</b>	474555-474563	0,399

**COMANDI FLESSIBILI FUNE FRENO A MANO - BRAKE CABLES - CABLES DE FREIN  
BREMSEILE - CABLES DE FRENO - CABOS DE TRAVAO  
LINKI HAMULCA - BRZDOVÁ LANKA - ТРОСЫ РУЧНОГО ТОРМОЗА**

				OEM REF.	
<b>PEUGEOT</b>					
205 all (exc. GTI) (RH-DX)	83=>	1135/1430	<b>07.963</b>	474556-474564	0,343
205 GTI (130 cv) (disc brake) (LH-SX)	87=>	1180/1425	<b>07.962A</b>	474567	0,409
205 GTI (130 cv) (disc brake) (RH-DX)	87=>	1185/1430	<b>07.963A</b>	474568	0,390
206 all (drum brake) (LH/RH-SX/DX)	98=>	1303/1638	<b>07.0697</b>	4745N4	0,417
206 1,6-2,0 GT all (disc brake) (LH/RH-SX/DX)	98=>	1425/1707	<b>07.0921</b>	4745N5	0,459
207 all (disc brake) (LH/RH-SX/DX)	06=>	1115/1907	<b>07.1541</b>	4745Z4-9650902680	•
207 all (drum brake) (LH/RH-SX/DX)	06=>	945/1796	<b>07.1542</b>	4745Z3-9650902580	•
208 (drum brake) (LH/RH-SX/DX)	12=>	915/1790	<b>07.2019</b>	9671813380	•
208 (disc brake) (LH/RH-SX/DX)	12=>	1105/1910	<b>07.2020</b>	9802570580	•
1007 all (drum brake) (LH/RH-SX/DX)	05/05=>	800/1610	<b>07.1095</b>	4750W3-474615-9648084880 9680318880	0,346
1007 all (disc brake) (LH/RH-SX/DX)	05/05=>	935/1700	<b>07.1096</b>	4750W4-474616-9639346180 9680313780	0,455
304 (LH/RH-SX/DX)	70=>	920/1555	<b>07.718</b>	483440-483466	0,363
305 all (exc.Break) (LH/RH-SX/DX)	=>07/82	965/1590	<b>07.767</b>	483467-483471	0,344
305 all (exc.Break) (LH/RH-SX/DX)	08/82=>	940/1570	<b>07.964</b>	483480	0,335
305 Break (LH/RH-SX/DX)	=>07/82	1080/1750	<b>07.835</b>	483475	0,399
305 Break (LH/RH-SX/DX)	08/82=>	1020/1670	<b>07.807</b>	483485	0,364
306 all (drum brake) (LH-SX)	92=>	1345/1655	<b>07.687</b>	474597	0,498
306 all (drum brake) (RH-DX)	92=>	1260/1560	<b>07.688</b>	474598	0,509
306 all (disc brake) (LH-SX)	92=>	1435/1695	<b>07.693</b>	474599-4745A1-96190724	0,498
306 all (disc brake) (RH-DX)	92=>	1350/1615	<b>07.694</b>	4745A0-4745A2-96190725	0,513
306 all ABS (drum brake) (RH-DX)	92=>	1255/1615	<b>07.0268</b>	4745A5-4745N9-9622434980	0,487
306 all ABS-Break (drum brake) (LH-SX)	92=>	1335/1690	<b>07.0922</b>	4745N8-4745A4-9617667980	0,442
306 Cabrio (drum brake) (LH-SX)	94=>	1270/1585	<b>07.347</b>	4745F8	0,368
306 Cabrio (drum brake) (RH-DX)	94=>	1350/1495	<b>07.346</b>	4745G1	0,347
306 Cabrio ABS (drum brake) (LH-SX)	94=>	1265/1620	<b>07.0149</b>	4745F7-96145739	0,462
306 Cabrio ABS (drum brake) (RH-DX)	94=>	1180/1530	<b>07.0159</b>	4745G0-9614574080	0,429
306 Cabrio (disc brake) (LH-SX)	94=>	1350/1615	<b>07.349</b>	4745F6	0,412
306 Cabrio (disc brake) (RH-DX)	94=>	1270/1540	<b>07.354</b>	4745F9	0,369
306 Cabrio ABS mod.-Kit 2 pcs. (LH/RH-SX/DX)	94=>	1170/1530+ 1260/1620	<b>07.1604</b>	4745E8	•
307 all Berlina	02=>	1183/2035	<b>07.0924</b>	4745T3-9636664680	0,554
307 all Break	02=>	1316/2115	<b>07.0925</b>	4745T9-9641453080	0,594
308 all (LH/RH-SX/DX)	07=>	1188/2033	<b>07.1623</b>	474631	•
308 Break-SW all (LH/RH-SX/DX)	08=>	1330/2128	<b>07.1800</b>	474640-9681881080	•
308 1,6 THP 200cv (LH/RH-SX/DX)	07/10=>	1205/2070	<b>07.1919</b>	474667	0,562
308 CC 1,6 GTI THP 200cv (LH/RH-SX/DX)	07/10=>	1205/2070	<b>07.1919</b>	474667	0,562
309 all (exc.GTI) (drum brake) (LH-SX)	85=>	1170/1445	<b>07.837</b>	474565	0,383
309 all (exc.GTI) (drum brake) (RH-DX)	85=>	1200/1470	<b>07.838</b>	474566	0,335
309 GTI 130cv all (disc brake) (LH-SX)	87=>	1230/1475	<b>07.263</b>	474569	0,377
309 GTI 130cv all (disc brake) (RH-DX)	87=>	1250/1495	<b>07.266</b>	474570	0,381

**COMANDI FLESSIBILI FUNE FRENO A MANO - BRAKE CABLES - CABLES DE FREIN  
BREMSEILE - CABLES DE FRENO - CABOS DE TRAVAO  
LINKI HAMULCA - BRZDOVÁ LANKA - ТРОСЫ РУЧНОГО ТОРМОЗА**

				OEM REF.	
<b>PEUGEOT</b>					
3008 all (LH/RH-SX/DX)	05/09=>	665/830	<b>07.1942</b>	474656-474670-474677 9675491780	0,283
5008 all (LH-SX)	09/09=>	765/935	<b>07.1981</b>	474664-474679-9672955480 9675503880	0,290
5008 all (RH-DX)	09/09=>	784/970	<b>07.1982</b>	474665-474678-9672955380 9675501780	0,285
405 all ( <b>front-avt</b> )	87=>	1560/1865	<b>07.085</b>	474571	0,490
405 all (exc.4x4) (drum brake) (LH-SX)	87=>	325/850	<b>07.086</b>	474573	0,172
405 all (exc.4x4) (drum brake) (RH-DX)	87=>	330/570	<b>07.830</b>	474574	0,148
405 all (exc.4x4) (disc brake) (LH-SX)	87=>	410/865	<b>07.834</b>	474575	0,183
405 all (exc.4x4) (disc brake) (RH-DX)	87=>	410/560	<b>07.702</b>	474576	0,155
406 all (drum brake) ( <b>front-avt</b> )	96=>	1410/1700	<b>07.0529</b>	4745H0-4745H9-4745L3 9616426480-9625818780	0,625
406 (ch. 8211-8575) high chassis ( <b>front-avt</b> )	99=>	1406/1610	<b>07.1257</b>	4745P1-4745P2-9632426480	0,652
406 all (ch. 8575-) high chassis ( <b>front-avt</b> )	99=>	1310/1656	<b>07.1258</b>	4745R7-4745R8	0,675
406 all (drum brake) (LH-SX)	96=>	550/825	<b>07.0272</b>	4745H1-9623328980	0,247
406 all (drum brake) (RH-DX)	96=>	550/750	<b>07.0273</b>	4745H2-4745L5-9623329080 9630504580	0,231
406 all (disc brake) (LH-SX)	96=>	500/695	<b>07.0274</b>	4745H3-9616427180	0,202
406 all (-ch.7475) (disc brake) (RH-DX)	96=>	500/630	<b>07.0275</b>	4745H4-9616427580	0,193
406 all (ch. 7476-) (disc brake) (RH-DX)	97=>	500/645	<b>07.0698</b>	4745L6	0,183
406 Coupé all (LH-SX)	97=>	510/705	<b>07.0699</b>	4745J6	0,199
406 Coupé all (RH-DX)	97=>	510/645	<b>07.0700</b>	4745J7	0,185
406 all (-ch. 8512) (drum brake) (LH-SX)	04/00=>	547/824	<b>07.0926</b>	4745R1	0,240
406 all (-ch. 8512) (drum brake) (RH-DX)	04/00=>	547/750	<b>07.0927</b>	4745R2-9638603980	0,208
407 all (LH/RH-SX/DX)	05=>	1330/2155	<b>07.1415</b>	4745X4	0,638
504 GL ( <b>front-avt</b> )	=>72	1525/1850	<b>07.570</b>	474520-474533	0,467
504 GL (LH/RH-SX/DX)	=>09/72	820/1045	<b>07.571</b>	483438	0,292
504 GL (LH/RH-SX/DX)	10/72=>12/76	1130/1655	<b>07.573</b>	483452	0,419
504 GL (LH/RH-SX/DX)	12/76=>09/77	1110/1635	<b>07.722</b>	483463	0,410
504 GL (LH/RH-SX/DX)	10/77=>	990/1595	<b>07.723</b>	483468	0,287
504 GL (LH/RH-SX/DX)	07/73=>	1500/1700	<b>07.576</b>	483458	0,465
504 L (LH-SX)	73=>	1540/1735	<b>07.575</b>	483456	0,491
504 GL (bench seats) (LH-SX)	07/73=>	990/1320	<b>07.577</b>	483454	0,360
504 GL (bench seats) (RH-DX)	07/73=>	1320/2295	<b>07.578</b>	483455	•
504 Break ( <b>front-avt</b> )	=>79	625/1050	<b>07.719</b>	474535	0,158
504 Break ( <b>front-avt</b> )	79=>	990/1560	<b>07.768</b>	474545	•
504 Break (LH-SX)	=>79	1100/1410	<b>07.720</b>	483446	0,340
504 Break (bench seats) (LH-SX)	=>79	1100/1410	<b>07.720</b>	483446	0,340
504 Break (RH-DX)	=>79	1100/2315	<b>07.721</b>	483451-483447	0,392
504 Break (bench seats) (RH-DX)	=>79	1100/2315	<b>07.721</b>	483451-483447	0,392
504 Break (LH/RH-SX/DX)	=>10/72	1560/1775	<b>07.574</b>	483457	0,510
504 Break (bench seats) (LH-SX)	80=>	1100/1410	<b>07.720</b>	483446	0,340
504 Break (bench seats) (RH-DX)	80=>	1350/2320	<b>07.874</b>	483474	0,469
504 (only UK) ( <b>front-avt</b> )	84=>	830/1310	<b>07.695</b>	474560	1,022
505 Break ( <b>front-avt</b> )	05/79=>	1335/1565	<b>07.967</b>	474553	0,471
505 GR-SR-GLD-TD (LH/RH-SX/DX)	05/79=>	1000/1630	<b>07.808</b>	483472	0,360

**COMANDI FLESSIBILI FUNE FRENO A MANO - BRAKE CABLES - CABLES DE FREIN  
BREMSEILE - CABLES DE FRENO - CABOS DE TRAVAO  
LINKI HAMULCA - BRZDOVÁ LANKA - ТРОСЫ РУЧНОГО ТОРМОЗА**

				<b>OEM REF.</b>	
---	---	---	--	-----------------	---





<b>PEUGEOT</b>					
505 TI-STI-GTI-TD (LH/RH-SX/DX)	05/79=>	1140/1660	<b>07.809</b>	483473	0,443
505 Break (LH/RH-SX/DX)	05/79=>	1100/1800	<b>07.968</b>	483477	0,406
505 Break (bench seats) (RH-DX)	05/79=>	365/1600	<b>07.704</b>	483479-483482	0,176
505 Break (bench seats) (LH-SX)	05/79=>	430/1190	<b>07.705</b>	483478	0,184
505 Break (bench seats) (LH-SX)	07/84=>	365/1245	<b>07.087</b>	483481	0,191
604 all (LH/RH-SX/DX)	09/77=>	1060/1720	<b>07.947</b>	483465	0,409
605 all (front-avt)	91=>	390	<b>07.697</b>	474581	0,042
605 all (interm.)	91=>	1500/1640	<b>07.449</b>	474582	0,467
605 all (LH-SX)	91=>	395/745	<b>07.455</b>	474583	0,177
605 all (RH-DX)	91=>	400/630	<b>07.460</b>	474584	0,163
605 all (LH-SX)	93=>	386/743	<b>07.0276</b>	4745F0	0,165
605 all (RH-DX)	93=>	386/635	<b>07.0277</b>	4745F1	0,157
607 all (front-avt)	05/99=>	1675/2145	<b>07.0928</b>	4745P7	0,804
607 all (LH-SX)	05/99=>	386/724	<b>07.0929</b>	4745P8	0,153
607 all (RH-DX)	05/99=>	386/713	<b>07.0930</b>	4745P9	0,162
607 all (LH-SX)	05=>	474/815	<b>07.1416</b>	4745X6	•
607 all (RH-DX)	05=>	474/794	<b>07.1417</b>	4745X7	0,253
806 all (front-avt)	95=>	255/500	<b>07.0166</b>	4745E9-1472957080	0,132
806 all (drum brake) (LH-SX)	95=>	770/1065	<b>07.0167</b>	1473322080-4745F2	1,065
806 all (drum brake) (RH-DX)	95=>	2050/2310	<b>07.0168</b>	1473321080-4745F3	0,912
806 (disc brake) (LH-SX)	95=>	1060/1255	<b>07.0170</b>	1472959080-4745F4	0,444
806 (disc brake) (RH-DX)	95=>	2080/2205	<b>07.0169</b>	4745F5-1472958080	0,817
806 (RHD only) (drum brake) (LH-SX)	00=>	1096/1300	<b>07.0849</b>	4745R4-1483708080	0,537
806 (RHD only) (drum brake) (RH-DX)	00=>	1980/2105	<b>07.0850</b>	4745R3	0,933
807 all (front-avt)	06/02=>	255/500	<b>07.0166</b>	4745T5	0,132
807 all (RH-DX)	06/02=>	2220/2360	<b>07.1105</b>	4745T7-4745T8	0,807
807 all (LH-SX)	06/02=>	840/1068	<b>07.1106</b>	4745T6	0,326
807 all (RH-DX)	05=>	2150/2310	<b>07.1341</b>	1400310280-1400310180 4745Y6-4745Y7	0,840
807 all (LH-SX)	05=>	840/1041	<b>07.1342</b>	4745Y8-1400310380	0,408
807 all (drum brake) (LH/RH-SX/DX)	06=>	1275/1495	<b>07.1922</b>	474610-1400203780	0,551
807 all (disc brake) (LH/RH-SX/DX)	06=>	1467/1613	<b>07.1923</b>	474611-1400203680	0,536
807 all (front-avt)	05=>	305/500	<b>07.1924</b>	474622-1400813580	0,140
807 all MPV/VAN (LH/RH-SX/DX)	03/07=>	1114/1255	<b>07.1774</b>	474609-1400204180	0,478



**PEUGEOT - Commercial Vehicle**

404 U6	09/68=>70	1320+1320/ 4050	<b>07.557</b>	483443	0,787
404 U8-U10 (LH/RH-SX/DX)	=>08/69	1620/2040	<b>07.559</b>	483437	0,480
404 U8-U10	69=>70	1620+1620/ 4170	<b>07.560</b>	483444	1,027
404 U8-U10	70=>	1630+1630/ 4090	<b>07.561</b>	483449	1,030
404 all (front-avt)	09/70=>	670/980	<b>07.554</b>	474538	0,410

**COMANDI FLESSIBILI FUNE FRENO A MANO - BRAKE CABLES - CABLES DE FREIN  
BREMSSEILE - CABLES DE FRENO - CABOS DE TRAVAO  
LINKI HAMULCA - BRZDOVÁ LANKA - ТРОСЫ РУЧНОГО ТОРМОЗА**

				OEM REF.	
<b>PEUGEOT - Commercial Vehicle</b>					
504 Camionette (front-avt)	79=>	725/1245	<b>07.831</b>	474547	0,263
504 Camionette (LH-SX)	79=>	1090/1495	<b>07.832</b>	483470	0,382
504 Camionette (RH-DX)	79=>	1030/1330	<b>07.833</b>	483469	0,412
Partner/Ranch all (LH-SX)	96=>	1405/1745	<b>07.0575</b>	4745J0-96222503-4745X8	0,518
Partner/Ranch all (RH-DX)	96=>	1480/1820	<b>07.0576</b>	4745J3-96277119	0,527
Partner/Ranch all (orga 08394-) (RH-DX)	97=>	1510/1850	<b>07.0828</b>	4745R0-96391792	0,530
Partner all (disc brake) (LH-SX)	06/04=>	1555/1820	<b>07.1339</b>	4745Y0	0,660
Partner all (disc brake) (RH-DX)	06/04=>	1640/1922	<b>07.1340</b>	4745Y1	0,707
Partner all	08=>	1300/2402	<b>07.1853</b>	474646	•
Bipper all BZ (RH/DX)	12/07=>	1442/1695	<b>07.1568</b>	474643	0,656
Bipper all BZ (LH/SX)	12/07=>	1407/1662	<b>07.1569</b>	474642	0,624
Bipper all D 1,4 Hdi (RH-DX)	12/07=>	1435/1710	<b>07.1570</b>	474645	0,655
Bipper all D 1,4 Hdi (LH-SX)	12/07=>	1402/1677	<b>07.1571</b>	474644	0,655
Expert all (front-avt)	95=>	256/500	<b>07.0166</b>	4745E9	0,132
Expert all (front-avt)	05=>	305/500	<b>07.1924</b>	474622-1400813580	0,140
Expert 1,6-D (drum brake) (LH-SX)	95=>	770/1065	<b>07.0167</b>	4745F2	1,065
Expert 1,6-D (drum brake) (RH-DX)	95=>	2050/2310	<b>07.0168</b>	4745F3	0,912
Expert TD (disc brake) (LH-SX)	95=>	1060/1255	<b>07.0170</b>	4745F4	0,444
Expert TD (disc brake) (RH-DX)	95=>	2080/2205	<b>07.0169</b>	4745F5	0,817
Expert 1,6 D LWB (drum brake) (RH-DX)	95=>	2145/2368	<b>07.1266</b>	4745G8	0,999
Expert all (drum brake) (LH/RH-SX/DX)	06=>	1275/1495	<b>07.1922</b>	474610-1400203780	0,551
Expert all (SWB short) (LH/RH-SX/DX)	06=>	1467/1613	<b>07.1923</b>	474611-1400203680	0,536
Expert all (LWB long) (LH/RH-SX/DX)	06=>	1590/1730	<b>07.1882</b>	474612-1400204880	0,680
J5 all (front-avt)	81=>	2160/2355	<b>07.842</b>	474554	0,830
J5 all (front-avt)	81=>	1430/1620	<b>07.797</b>	474552	0,574
J5 all	81=>	715+715/ 2590	<b>07.796</b>	483476	0,554
Boxer all (front-avt)	94=>	761/1059	<b>07.0171</b>	4745G2-1308638080	0,468
Boxer all	94=>	810+810/ 3025	<b>07.0172</b>	4745G3-1307963080	0,748
Boxer (Camping Car)	94=>	810+810/ 3040	<b>07.0830</b>	4745G7	0,699
Boxer all (ch. 16158428-)	=>01	865+865/ 2806	<b>07.1363</b>	4745V2-1330058080	0,748
Boxer all (front-avt)	01=>	761/1078	<b>07.1110</b>	4745V6-1336889080	0,484
Boxer all (drum brake)	02=>	875+875/ 2825	<b>07.1365</b>	4745V5-1337440080	0,693
Boxer 4x4 (only UK) (front-avt)	=>02	843/1170	<b>07.1343</b>	4745V7-1337455080	•
Boxer II all (front-avt)	02=>	645/1463	<b>07.1345</b>	4745W6-1338683080	0,404
Boxer II all (disc brake) (LH/RH-SX/DX)	02=>	782/955	<b>07.1346</b>	4745W7-1338691080	0,376
Boxer all (disc brake)	02=>	890+890/ 2715	<b>07.1366</b>	4745V4-4745W5-1339676080 1339394080	0,838
Boxer III all 30-33-35 (LH/RH-SX/DX)	06=>	1075/1385	<b>07.1883</b>	474617	0,486
Boxer III all 40 (LH/RH-SX/DX)	06=>	1170/1480	<b>07.1925</b>	474618	0,459
Boxer III all 30-35 passo 3450 (front-avt)	06=>	2035/2295	<b>07.1926</b>	474627-1350313080	0,895
Boxer III p. 3800/p. 3800 Fap mod. (front-avt)	06=>	2390/2645	<b>07.1676</b>	474629-474650-1350314080 1359247080	1,005
Boxer III p. 3000/p. 3000 Fap mod. (front-avt)	06=>	1650/1910	<b>07.1677</b>	474647-4745Z9-1341023080 1359245080	0,763

**COMANDI FLESSIBILI FUNE FRENO A MANO - BRAKE CABLES - CABLES DE FREIN  
BREMSSEILE - CABLES DE FRENO - CABOS DE TRAVAO  
LINKI HAMULCA - BRZDOVÁ LANKA - ТРОСЫ РУЧНОГО ТОРМОЗА**

				<b>OEM REF.</b>	
---	---	---	--	-----------------	---

**PEUGEOT - Commercial Vehicle**

Boxer III p. 4035/p. 4035 Fap mod. (front-avt)	06=>	2650/2910	<b>07.1678</b>	474649-474628-1350315080 1359248080	1,399
J7 all (LH-SX)	68=>73	685/925	<b>07.872</b>	483226	0,267
J7 all (RH-DX)	68=>73	1070/1170	<b>07.870</b>	483227	•
J7/J9 all (LX-SX)	09/73=>	785/955	<b>07.884</b>	483228	0,276
J7/J9 all (RX-DX)	09/73=>	1200/1365	<b>07.972</b>	483229	0,422

**POLSKI**

126 P all	73=>	735+735/ 2360	<b>07.100</b>	4273200	0,683
126 Bis	87=>	780+780/ 2350	<b>07.977</b>	4345508	0,714
125 P/Polonez 1,3-1,5		675+675/ 2460	<b>07.129</b>	4294024	0,800





**PORSCHE**

911	72=>	730/1407	<b>07.1801</b>	90142455102	•
Cayenne all (LH/RH-SX/DX)	92=>95	1640/1750	<b>07.1754</b>	95542414110	0,620





**RENAULT**

R4 all (LH-SX)	=>10/66	830/1035	<b>07.414</b>	854693100	0,285
R4 all (RH-DX)	=>10/66	1275/1470	<b>07.415</b>	854693200	0,411
R4 L-TL (1120-23-26) (LH-SX)	66=>	820/1055	<b>07.410</b>	7701348035	0,295
R4 L-TL (1120-23-26) (RH-DX)	66=>	1265/1495	<b>07.411</b>	7701348034	0,436
R4 L-TL (1120-23-26) (RH-DX)	75=>	1340/1590	<b>07.726</b>	7700571740	0,451
R4 GTL-R4 F6 (1128) (LH-SX)	76=>	825/1075	<b>07.412</b>	7700510747	0,280
R4 GTL-R4 F6 (RH-DX)	=>75	1290/1530	<b>07.413</b>	7700510748	0,404
R4 GTL-R4 F6 (1128) (RH-DX)	76=>	1235/1445	<b>07.727</b>	7700571739-7700560787	0,450
R4 GTL-R4 F6 (1128) (RH-DX)	80=>82	1335/1585	<b>07.235</b>	7700571741	0,420
R4 GTL (1128) (front-avt)	83=>	740/2470	<b>07.408</b>	7702107376	0,308
R4 GTL-R4 F6 (LH-SX)	83=>	920/1040	<b>07.422</b>	7701348267	0,363
R4 GTL-R4 F6 (RH-DX)	83=>	1090/1215	<b>07.423</b>	7701348269	•
R4 GTL (LH/RH-SX/DX)	84=>	1340/1525	<b>07.664</b>	7704001812	0,355
R4 F6 Cargo (LH/RH-SX/DX)	84=>	1480/1665	<b>07.418</b>	7704001811	0,461
Twingo all (LH/RH-SX/DX)	93=>	1050/1435	<b>07.300</b>	7700824636	0,362
Twingo all (exc.ABS) (LH/RH-SX/DX)	98=>	1055/1460	<b>07.0703</b>	7700424929	0,398
Twingo all ABS (LH/RH-SX/DX)	98=>	1055/1445	<b>07.0704</b>	7700427498	0,349
Twingo II all (RH-DX)	04/07=>	1043/1355	<b>07.1804</b>	8200428323	•
Twingo II all (LH-SX)	04/07=>	960/1275	<b>07.1805</b>	8200428320	0,318
R5 L (front-avt)	72=>82	230/495	<b>07.728</b>	7700539993	0,120
R5 L (LH-SX)	72=>79	660/2140	<b>07.416</b>	7700539991	0,312
R5 L (RH-DX)	72=>79	670/900	<b>07.417</b>	7700539992	0,230
R5 TL-TS-GTL (LH-SX)	72=>79	1480/1665	<b>07.418</b>	7700539865-7700539994	0,470
R5 TL-TS-GTL (LH-SX)	80=>	1480/1665	<b>07.418</b>	7704001811-7701348487	0,470
R5 TL-TS-GTL (RH-DX)	80=>	1340/1525	<b>07.664</b>	7704001812-7701348486	0,355
R5 L (LH-SX)	80=>82	650/2180	<b>07.878</b>	7700554894	0,309
R5 L (RH-DX)	80=>82	650/935	<b>07.877</b>	7700554896	0,243
R5 L (LH-SX)	83=>	1480/1665	<b>07.418</b>	7704001811-7701348487	0,470





**COMANDI FLESSIBILI FUNE FRENO A MANO - BRAKE CABLES - CABLES DE FREIN  
BREMSEILE - CABLES DE FRENO - CABOS DE TRAVAO  
LINKI HAMULCA - BRZDOVÁ LANKA - ТРОСЫ РУЧНОГО ТОРМОЗА**

				OEM REF.	
<b>RENAULT</b>					
R5 L (RH-DX)	83=>	1340/1525	<b>07.664</b>	7704001812-7701348486	0,355
R5 TL-LS-GTL (RH-DX)	72=>79	1345/1530	<b>07.419</b>	7700539866-7700539995	0,419
R5 Alpine (LH/RH-SX/DX)	=>84	1465/1590	<b>07.032</b>	7701022736-6000056930	0,473
Supercinque all (LH/RH-SX/DX)	84=>	1135/1350	<b>07.407</b>	7700754882-7700754886	0,397
Supercinque GT T (LH/RH-SX/DX)	85=>	1220/1405	<b>07.236</b>	6001006990	0,434
Clio all (drum brake) (LH/RH-SX/DX)	90=>	1125/1460	<b>07.420</b>	7700802685	0,447
Clio 16v (disc brake) (LH/RH-SX/DX)	91=>	1190/1480	<b>07.421</b>	7700802686	0,498
Clio 1,2-1,4 (drum brake) (RH-DX)	98=>	1090/1345	<b>07.0705</b>	7700424926	0,375
Clio 1,2-1,4 (drum brake) (LH-SX)	98=>	1000/1265	<b>07.0706</b>	7700424928	0,344
Clio 1,6-1,9 D (disc brake) (RH-DX)	98=>	1090/1355	<b>07.0707</b>	7700426005	0,384
Clio 1,6-1,9 D (disc brake) (LH-SX)	98=>	1005/1275	<b>07.0708</b>	7700426006	0,324
Clio 16v (exc.ABS) (RH-DX)	98=>	1000/1320	<b>07.0933</b>	8200087982	0,366
Clio 16v (exc.ABS) (LH-SX)	98=>	1080/1400	<b>07.0934</b>	8200087981	0,460
Clio 16v ABS (RH-DX)	98=>	1340/1000	<b>07.0935</b>	8200087979-7700433238	0,373
Clio 16v ABS (LH-SX)	98=>	1085/1410	<b>07.0936</b>	8200087977-7700433237	0,461
Clio 2,0 16v (RH-DX)	98=>	1173/1380	<b>07.1268</b>	6000073539	•
Clio 2,0 16v (LH-SX)	98=>	1103/1310	<b>07.1269</b>	6000073540	0,389
Clio III all (drum brake) (RH-DX)	05=>	1336/1451	<b>07.1418</b>	8200270181	0,476
Clio III all (drum brake) (LH-SX)	05=>	1209/1323	<b>07.1419</b>	8200270182	0,432
Clio III all (disc brake) (RH-DX)	05=>	1430/1587	<b>07.1420</b>	8200298383	0,505
Clio III all (disc brake) (LH-SX)	05=>	1292/1451	<b>07.1421</b>	8200298384	0,454
Clio 1,5 Dci-2,0 16v (RH-DX)	07/01=>	1170/1450	<b>07.1743</b>	8200228260	0,407
Clio 1,5 Dci-2,0 16v (LH-SX)	07/01=>	1101/1378	<b>07.1744</b>	8200228347	0,346
Clio III all (disc brake) (RH-DX)	07=>	1498/1596	<b>07.1879</b>	8200662794	•
Clio III all (disc brake) (LH-SX)	07=>	1362/1458	<b>07.1880</b>	8200662793	•
Clio III 1,5 dCi (drum brake) Ø16 (RH-DX)	08/10=>	1405/1570	<b>07.1988</b>	8200577938	0,475
Clio III 1,5 dCi (drum brake) Ø16 (LH-SX)	08/10=>	1275/1440	<b>07.1989</b>	8200577939	0,445
R6 TL (front-avt)	10/70=>	785/2375	<b>07.424</b>	7701348270	0,281
R6 (1180) (LH-SX)	10/70=>	825/1075	<b>07.412</b>	7700510747	0,280
R6 (1180) (RH-DX)	=>08/73	1290/1530	<b>07.413</b>	7700510748	0,404
R6 (RH-DX)	09/73=>	1235/1445	<b>07.727</b>	7700571739-7700560787	0,450
R6 TL (LH-SX)	10/70=>	920/1040	<b>07.422</b>	7701348267-7700529227	0,363
R6 TL (RH-DX)	10/70=>	1090/1215	<b>07.423</b>	7700529226-7701348269	•
R9 all (exc.T) (LH/RH-SX/DX)	81=>	1260/1485	<b>07.876</b>	7704001610-7700759586 7700760876	0,468
R9 T (LH/RH-SX/DX)	81=>	1240/1420	<b>07.055</b>	7700773849	0,490
R11 all (exc.T) (LH/RH-SX/DX)	81=>	1260/1485	<b>07.876</b>	7704001610-7700759586 7700760876	0,468
R11 T (LH/RH-SX/DX)	81=>	1240/1420	<b>07.055</b>	7700773849	0,490
R12 L-TL-TS	10/72=>	565+565/ 2150	<b>07.735</b>	7700536338	0,345
R12 TS	79=>	580+580/ 2160	<b>07.736</b>	7701348283	0,492
R14 all (LH-SX)	76=>	1070/1340	<b>07.841</b>	7700640322-7700640323 7701348856-7702104343	0,350
R14 all (RH-DX)	76=>	1025/1295	<b>07.839</b>	7700623400-7700614407 7701348855-7702104344	0,335

**COMANDI FLESSIBILI FUNE FRENO A MANO - BRAKE CABLES - CABLES DE FREIN  
BREMSSSEILE - CABLES DE FRENO - CABOS DE TRAVAO  
LINKI HAMULCA - BRZDOVÁ LANKA - ТРОСЫ РУЧНОГО ТОРМОЗА**

				OEM REF.	
<b>RENAULT</b>					
R15	72=>	565+565/ 2150	<b>07.735</b>	7700536338	0,345
R15	79=>	580+580/ 2160	<b>07.736</b>	7701348283	0,492
R16 all (front-avt)	70=>	1800/2260	<b>07.744</b>	7700533777	0,445
R16 all (RH-DX)	70=>	600/960	<b>07.824</b>	7701348404	0,242
R16 all (LH-SX)	=>74	575/1170	<b>07.825</b>	7701348403	0,390
R17	73=>78	565+565/ 2150	<b>07.735</b>	7700536338	0,345
R18 all (LH-SX)	78=>	580/1180	<b>07.748</b>	7704002268	0,228
R18 all (RH-DX)	78=>	580/590	<b>07.749</b>	7704002272	0,328
R18 TX-GTX-T-Break (LH-SX)	78=>	570/1210	<b>07.973</b>	7704002269-7704002271	0,299
R18 TX-GTX-T-Break (RH-DX)	78=>	570/990	<b>07.974</b>	7704002273-7704002275	0,353
R18 Break-T (LH-SX)	81=>	725/1260	<b>07.238</b>	7704002266-7700701649	0,378
R18 Break-T (RH-DX)	81=>	720/1020	<b>07.239</b>	7704002267-7700701650	0,370
Fuego TL-GTL (LH-SX)	80=>	580/1180	<b>07.748</b>	7700657227	0,228
Fuego TL-GTL (RH-DX)	80=>	580/950	<b>07.749</b>	7700657234	0,328
Fuego TS-GTS-TX-GTX (LH-SX)	80=>	570/1210	<b>07.973</b>	7701349109	0,299
Fuego TS-GTS-TX-GTX (RH-DX)	80=>	570/990	<b>07.974</b>	7701349110	0,353
Fuego T (LH-SX)	80=>	725/1260	<b>07.238</b>	7704002266	0,378
Fuego T (RH-DX)	80=>	720/1020	<b>07.239</b>	7704002267	0,370
R19 all (exc.ABS) (LH/RH-SX/DX)	88=>	1290/1590	<b>07.033</b>	7700781393	0,489
R19 Chamade (drum brake) (LH/RH-SX/DX)	05/89=>	1290/1580	<b>07.470</b>	7700816858	0,529
R19 16v ABS (LH/RH-SX/DX)	89=>	1300/1570	<b>07.471</b>	7700781394-7700817136	0,521
R20 all (LH/RH-SX/DX)	76=>	810/1030	<b>07.875</b>	7701348316-7700571639	0,320
R21 TL-TS-GTS-RS-TSE-TD-GTD (LH/RH-SX/DX)	86=>	1260/1490	<b>07.240</b>	7700766098	0,492
R21 RX-RXE 2L (drum brake) (LH/RH-SX/DX)	86=>	1260/1520	<b>07.241</b>	7700769840	0,473
R21 T ABS (disc brake) (LH/RH-SX/DX)	86=>	1420/1605	<b>07.472</b>	7700777520	0,505
R21 Nevada (exc.ABS) (LH/RH-SX/DX)	86=>	1410/1670	<b>07.350</b>	7700769842	0,572
R21 Nevada ABS (LH/RH-SX/DX)	86=>	1575/1750	<b>07.473</b>	7700785543	0,590
R21 Nevada 4x4 (LH/RH-SX/DX)	90=>	1220/1515	<b>07.479</b>	7700785175	0,481
R25 (exc.ABS) (LH/RH-SX/DX)	84=>	810/1030	<b>07.875</b>	7701348316-7700571639	0,320
R25 ABS (LH/RH-SX/DX)	84=>	970/1090	<b>07.751</b>	7700571640-7701348781	0,390
R30 T (LH/RH-SX/DX)	80=>	810/1030	<b>07.875</b>	7701348316-7700571639	0,320
R30 TX-TS (LH/RH-SX/DX)	84=>	970/1090	<b>07.751</b>	7700571640-7701348781	0,390
Laguna all (exc.SW-ABS) (drum brake) (LH/RH-SX/DX)	94=>	955/1185	<b>07.0278</b>	7700823689	0,389
Laguna SW-Break (drum brake) (LH/RH-SX/DX)	94=>	930/1190	<b>07.0710</b>	7700841026	0,353
Laguna all ABS (disc brake) (LH/RH-SX/DX)	94=>	1065/1245	<b>07.0279</b>	7700823690	0,427
Laguna all ABS (disc brake) (LH/RH-SX/DX)	02/97=>	990/1185	<b>07.0711</b>	7700422532	0,398
Laguna II all (LH/RH-SX/DX)	01=>	1235/2220	<b>07.0944</b>	8200002236	0,464
Laguna II 1,5 Dci all (LH/RH-SX/DX)	07=>	1060/1885	<b>07.1803</b>	364000001R	•

**COMANDI FLESSIBILI FUNE FRENO A MANO - BRAKE CABLES - CABLES DE FREIN  
BREMSEILE - CABLES DE FRENO - CABOS DE TRAVAO  
LINKI HAMULCA - BRZDOVÁ LANKA - ТРОСЫ РУЧНОГО ТОРМОЗА**

				OEM REF.	
<b>RENAULT</b>					
Megane 1,4-1,6 (drum brake) (LH/RH-SX/DX)	09/95=>	1080/1440	<b>07.0537</b>	7700834651-7700424470	0,422
Megane 2,0 16v (disc brake) (LH/RH-SX/DX)	09/95=>	1215/1520	<b>07.0538</b>	7700834653	0,448
Megane TD-Classic (drum brake) (LH/RH-SX/DX)	09/95=>	1115/1475	<b>07.0539</b>	7700846156-7700420314 7700424472	0,443
Megane Coach 1,4-1,6 16v (LH/RH-SX/DX)	09/95=>	1080/1335	<b>07.0540</b>	7700834652-7700424923	0,416
Megane Coach 2,0 16v (LH/RH-SX/DX)	09/95=>	1220/1410	<b>07.0541</b>	7700834654-7700424922	0,437
Megane Coach 1,4-1,6 (exc. 6V)-2,0 8v (LH/RH-SX/DX)	09/95=>	1115/1365	<b>07.0542</b>	7700846155-7700424469	0,440
Megane Scenic all (drum brake) (LH/RH-SX/DX)	96=>	1090/1475	<b>07.0709</b>	7700834655-7700424468	0,445
Megane SW Break (drum brake) (LH/RH-SX/DX)	98=>	1060/1455	<b>07.0938</b>	7700421024	0,461
Megane SW Break (disc brake) (RH-DX)	98=>	1205/1520	<b>07.0939</b>	8200035047	0,542
Megane SW Break (disc brake) (LH-SX)	98=>	1165/1480	<b>07.0940</b>	8200029461	0,435
Megane Scenic (disc brake) (RH-DX)	00=>	1175/1479	<b>07.0941</b>	7700432012	0,497
Megane Scenic (disc brake) (LH-SX)	00=>	1205/1508	<b>07.0942</b>	7700432266	0,456
Megane Scenic 4x4 (LH/RH-SX/DX)	00=>	1163/1467	<b>07.0943</b>	7700432013	0,410
Megane II all Berlina (LH/RH-SX/DX)	03=>	1080/2020	<b>07.1270</b>	8200247041	0,457
Megane II all Break-SW (LH/RH-SX/DX)	03=>	1080/2070	<b>07.1271</b>	8200247043-8200229445 8200243673	0,445
Megane II all Coupé-Cabrio (LH/RH-SX/DX)	03=>	1080/1940	<b>07.1272</b>	8200247042	0,441
Megane III (LH/RH-SX/DX)	09=>	1060/1885	<b>07.1803</b>	364000001R	•
Megane III (LH/RH-SX/DX)	09=>	1060/1940	<b>07.1881</b>	364000005R	•
Megane Scenic III 1,6 dCi, X-Mod III Multispace (LH/RH-SX/DX)	12/08=>	1060/1900	<b>07.1984</b>	364000004R	0,440
Megane Scenic III all (LH/RH-SX/DX)	12/08=>	1120/1960	<b>07.1990</b>	364000002R	0,406
Modus all (exc.ABS) (drum brake) (RH-DX)	04=>	1230/1387	<b>07.1422</b>	8200269350	0,432
Modus all (exc.ABS) (drum brake) (LH-SX)	04=>	1340/1497	<b>07.1423</b>	8200269348	0,468
Modus all ABS (disc brake) (RH-DX)	04=>	1262/1375	<b>07.1424</b>	8200214750	0,447
Modus all ABS (disc brake) (LH-SX)	04=>	1163/1275	<b>07.1425</b>	8200214752	0,412
Safrane all (exc.ABS) (LH-SX)	92=>	540/700	<b>07.0280</b>	7700812520	0,198
Safrane all (exc.ABS) (RH-DX)	92=>	790/955	<b>07.0281</b>	7700812521	0,332
Safrane all ABS (LH-SX)	92=>	760/850	<b>07.0282</b>	7700812524	0,439
Safrane all ABS (RH-DX)	92=>	1010/1090	<b>07.0283</b>	7700812525	0,581
Koleos all (manual) (LH-SX)	04/07=>	1605/1760	<b>07.1909</b>	36531JY00A	•
Koleos all (manual) (RH-DX)	04/07=>	1770/1610	<b>07.1910</b>	36530JY00A	•
Koleos all (manual) (front)	04/07=>	262	<b>07.1962</b>	36402JD00A	0,093
Espace (-ch. 5829) (LH-SX)	84=>86	850/1910	<b>07.135</b>	6025000831	0,359
Espace (-ch. 5829) (RH-DX)	84=>86	850/1185	<b>07.136</b>	6025000832	0,334
Espace (ch. 5830-) (drum brake) (LH-SX)	86=>	850/2010	<b>07.467</b>	6025002628	0,344
Espace (ch. 5830-) (drum brake) (RH-DX)	86=>	820/1045	<b>07.468</b>	6025002627	0,346
Espace ABS (LH-SX)	=>01/91	1050/1320	<b>07.497</b>	6025007115	0,365
Espace ABS (RH-DX)	=>01/91	1050/1940	<b>07.498</b>	6025007116	0,353
Espace (exc.ABS) (disc brake) (LH-SX)	01/91=>	1000/1285	<b>07.499</b>	6025105919	0,397
Espace (exc.ABS) (disc brake) (RH-DX)	01/91=>	1015/1890	<b>07.500</b>	6025105918	0,396
Espace 4x4 (LH-SX)	01/91=>	790/1075	<b>07.501</b>	6025006423	0,295
Espace 4x4 (RH-DX)	01/91=>	790/1700	<b>07.502</b>	6025006424	0,295
Espace short mod. (drum brake) (LH/RH-SX/DX)	96=>	1313/1520+ 1375/1583	<b>07.0945</b>	6025370468-6025313181 6025313182	0,568
Espace short mod. (disc brake) (LH/RH-SX/DX)	96=>	1431/1573+ 1494/1635	<b>07.0946</b>	6025370467-6025304630 6025304631	0,539

**COMANDI FLESSIBILI FUNE FRENO A MANO - BRAKE CABLES - CABLES DE FREIN  
BREMSSEILE - CABLES DE FRENO - CABOS DE TRAVAO  
LINKI HAMULCA - BRZDOVÁ LANKA - ТРОСЫ РУЧНОГО ТОРМОЗА**





				<b>OEM REF.</b>	
---	---	---	--	-----------------	---

<b>RENAULT</b>					
Grand Espace V6 SWB (disc brake)(LH/RH-SX/DX)	96=>	1495/1640+ 1545/1695	<b>07.1844</b>	6025371373	●
Grand Espace V6 LWB (disc brake)(LH/RH-SX/DX)	96=>	1650/1800+ 1710/1860	<b>07.1845</b>	6025371283	●
Grand Espace LWB (drum brake) (LH/RH-SX/DX)	01=>	1468/1675+ 1535/1740	<b>07.1274</b>	6025370827	0,994
Grand Espace LWB (disc brake) (LH/RH-SX/DX)	01=>	1468/1675+ 1535/1740	<b>07.1275</b>	6025370922	1,123



<b>RENAULT - Commercial Vehicle</b>					
R4 Furgonette (LH-SX)	=>06/66	830/1035	<b>07.414</b>	854693100	0,285
R4 Furgonette (RH-DX)	=>06/66	1275/1470	<b>07.415</b>	854693200	0,411
R4 Furgonette F4 (2106) (LH-SX)	07/66=>04/68	820/1055	<b>07.410</b>	7701348035	0,295
R4 Furgonette F4 (2106) (RH-DX)	07/66=>04/68	1265/1495	<b>07.411</b>	7701348034	0,436
R4 Furgonette F4 (2106) (RH-DX)	=>68	1340/1590	<b>07.726</b>	7700571740	0,451
R4 Furgonette F4 (2106-2109-2391-2392) (LH-SX)	04/68=>82	825/1075	<b>07.412</b>	7700510747	0,280
R4 Furgonette F4 (2106-2109-2391-2392) (RH-DX)	05/75=>07/82	1335/1585	<b>07.235</b>	7700571741	0,420
R4 Furgonette F4 (2106-2109-2391-2392) (RH-DX)	04/68=>05/75	1290/1530	<b>07.413</b>	7700510748	0,404
R4 Furgonette F4 (2106) (RH-DX)	07/82=>	1235/1445	<b>07.727</b>	7700571739-7700560787	0,450
R4 Furgonette F4 (210B-239B) (LH-SX)	83=>	920/1040	<b>07.422</b>	7701348267	0,363
R4 Furgonette F4 (210B-239B) (RH-DX)	83=>	1090/1215	<b>07.423</b>	7701348269	●
R4 Furgonette F4 (210B-239B) (LH/RH-SX/DX)	84=>	1340/1525	<b>07.664</b>	7704001812	0,355
R4 F6 Cargo (2370-2430) (front-avt)	07/82=>07/83	740/2470	<b>07.408</b>	7702107376	0,308
R4 F6 Cargo (2370-2430) (LH-SX)	76=>07/83	825/1075	<b>07.412</b>	7700510747	0,280
R4 F6 Cargo (2370-2430) (RH-DX)	76=>82	1235/1445	<b>07.727</b>	7700571739-7700560787	0,450
R4 F6 Cargo (2370-2430) (RH-DX)	=>07/82	1335/1585	<b>07.235</b>	7700571741	0,420
R4 F6 Cargo (2370-2430) (LH-SX)	07/82=>07/83	920/1040	<b>07.422</b>	7701348267	0,363
R4 F6 Cargo (2370-2430) (RH-DX)	07/82=>07/83	1090/1215	<b>07.423</b>	7701348269	●
R4 F6 Cargo (2370-2430) (LH/RH-SX/DX)	07/83=>	1480/1665	<b>07.418</b>	7704001811-7701348487	0,461
Express all (LH/RH-SX/DX)	84=>86	1135/1350	<b>07.407</b>	7700754882	0,397
Express all (LH/RH-SX/DX)	86=>07/91	1135/1350	<b>07.407</b>	7700754886	0,397
Express BZ (LH/RH-SX/DX)	08/91=>	1295/1590	<b>07.495</b>	6006000595	0,450
Express D (LH/RH-SX/DX)	08/91=>	1105/1485	<b>07.496</b>	6006000596	0,449
Kangoo all (pt 600 kg) (LH-SX)	97=>	1075/1415	<b>07.0712</b>	7700311698	0,387
Kangoo all (pt 600 kg) (RH-DX)	97=>	1085/1420	<b>07.0713</b>	7700311699	0,404
Kangoo all (pt 800 kg) (LH-SX)	97=>	1070/1430	<b>07.0714</b>	7700311700	0,407
Kangoo all (pt 800 kg) (RH-DX)	97=>	1080/1440	<b>07.0715</b>	7700311701	0,422
Kangoo 4x4 (LH/RH-SX/DX)	99=>	1235/1525	<b>07.1426</b>	8200040064-8200040065	0,471
Kangoo all 4x4 (LH-SX)	01=>06	1235/1525	<b>07.1806</b>	8200694016	●
Kangoo all 4x4 (RH-DX)	01=>06	1238/1525	<b>07.1807</b>	8200694022	●
Kangoo II all SWB (LH/RH-SX/DX)	08=>	920/1760	<b>07.1808</b>	8200577789	●
Kangoo II all (disc brake) (LH/RH-SX/DX)	08=>	776/1970	<b>07.1809</b>	8200935172	0,315
Kangoo II all (disc brake) (LH/RH-SX/DX)	08=>	920/2015	<b>07.1877</b>	8200526870	●
Trafic (front-avt)	81=>87	485/685	<b>07.887</b>	7700689738	0,201
Trafic all (LH-SX)	81=>87	955/1360	<b>07.880</b>	7700689739	0,370
Trafic all (RH-DX)	81=>87	1025/1430	<b>07.873</b>	7700689740	0,391

**COMANDI FLESSIBILI FUNE FRENO A MANO - BRAKE CABLES - CABLES DE FREIN  
BREMSEILE - CABLES DE FRENO - CABOS DE TRAVAO  
LINKI HAMULCA - BRZDOVÁ LANKA - ТРОСЫ РУЧНОГО ТОРМОЗА**

				OEM REF.	
<b>RENAULT - Commercial Vehicle</b>					
Trafic all (front-avt)	88=>	575/775	<b>07.272</b>	7700748744	0,252
Trafic all (LH-SX)	88=>	920/1310	<b>07.277</b>	7700732030	0,331
Trafic all (RH-DX)	88=>	1065/1450	<b>07.278</b>	7700732031	0,383
Trafic 2,4-2,5 D all (LH-SX)	03/89=>	935/1295	<b>07.0289</b>	7700723014	0,416
Trafic 2,4-2,5 D all (RH-DX)	03/89=>	1020/1390	<b>07.0290</b>	7700723015	0,469
Trafic all (front-avt)	03/89=>97	522/747	<b>07.0968</b>	7700307717-7700748444	0,220
Trafic all (exc.ABS) (LH-SX)	97=>	925/1330	<b>07.0969</b>	7700307720	0,385
Trafic all (exc.ABS) (RH-DX)	97=>	1020/1424	<b>07.0970</b>	7700307721	0,471
Trafic II 2,5 D 4x4 (front-avt)	05/98=>03/01	460/755	<b>07.1987</b>	7700748445	0,260
Trafic all (front-avt)	01=>	502	<b>07.0916</b>	7700312835-91166639	0,120
Trafic all SWB (interm.)	01=>	1185	<b>07.0917</b>	7700313058-91165521	0,126
Trafic all LWB (interm.)	01=>	1585	<b>07.0918</b>	8200008473-91165522	0,141
Trafic all (RH-DX)	01=>	1365/1495	<b>07.0919</b>	8200178389-91168672	0,467
Trafic all (LH-SX)	01=>	1465/1590	<b>07.0920</b>	8200178390-91168673	0,495
Trafic all RHD (front-avt)	01=>	355/600	<b>07.1427</b>	8200008472-91166640	0,151
Trafic all Cab. mod. (interm.)	01=>	1880	<b>07.2046</b>	4413816-93852378	•
Trafic all (RH-DX)	03=>	1365/1496	<b>07.1428</b>	8200263819-7700312837	0,516
Trafic all (LH-SX)	03=>	1465/1596	<b>07.1429</b>	8200263821-7700312836	0,542
Trafic III 2,0-2,5 DCi (front-avt)	11=>	260/498	<b>07.1971</b>	365301862R	0,123
Trafic III 2,0 BZ-2,0 DCi-2,5 DCi-LWB (interm.)	11=>	1643	<b>07.1972</b>	365301796R	0,171
Trafic III 2,0 BZ-2,0 DCi-2,5 DCi-SWB (interm.)	11=>	1245	<b>07.1973</b>	365301673R	0,155
Trafic all Cab. mod. (interm.)	11=>	1942	<b>07.1983</b>	365309636R	0,183
Trafic all LWB (KIT)	11=>	495+1645/ 260	<b>07.2017</b>	1605112	•
Trafic all SWB (KIT)	11=>	495+1245/ 260	<b>07.2018</b>	1605111-93168971	•
Master TR/AV (ch. 3,20) (front-avt)	81=>	1310/2695	<b>07.034</b>	5000387617	0,489
Master TR/AV (ch. 3,80) (front-avt)	81=>	1300/3260	<b>07.035</b>	5000388497-5000388438 5000395885	0,451
Master TR/AV (LH/RH-SX/DX)	=>82	965/1765	<b>07.036</b>	5000389550-5000387975	0,337
Master TR/AV (LH/RH-SX/DX)	82=>	930/1750	<b>07.280</b>	5000395882	0,326
Master TR/AV (ch. 3,20) (front-avt)	=>88	1260/2610	<b>07.1276</b>	5000395884	•
Master TR/AV (ch. 3,80) (front-avt)	=>88	1260/3247	<b>07.1277</b>	5000395885	0,419
Master PR/AR (ch. 3,80) (front-avt)	81=>	1885/3165	<b>07.038</b>	5000388522	0,539
Master PR/AR (LH/RH-SX/DX)	=>82	985/1795	<b>07.039</b>	5000388538	0,338
Master PR/AR (LH/RH-SX/DX)	82=>	970/1800	<b>07.503</b>	5000395883	0,323
Master 2,5 D (front-avt)	10/97=>	950/1180	<b>07.0716</b>	7700311216	0,395
Master 2,5 D (LH/RH-SX/DX)	10/97=>	1060/1420	<b>07.0717</b>	7700311217	0,358
Master 2,5 D-2,8 Dti LWB (LH/RH-SX/DX)	10/97=>	1440/1735	<b>07.0976</b>	9111490-4403490-8200021940 3640000QAD	0,555
SG 2 (front-avt)		435	<b>07.510</b>	23272270	0,047
SG 4 (LH/RH-SX/DX)		3120	<b>07.512</b>	23272264	0,544
<b>RENAULT DACIA</b>					
Logan (drum brake) powersteering (LH/RH-SX/DX)	04=>	1500/1675	<b>07.1430</b>	6001547168-8200215962	0,588
Logan (drum brake) (LH/RH-SX/DX)	04=>	1495/1665	<b>07.1431</b>	6001547169-8200380738	0,598
Logan MCV 1,5 Dci (drum brake) (LH/RH-SX/DX)	08=>	1478/1658	<b>07.1846</b>	6001549112	0,713
Sandero all (LH/RH-SX/DX)	08=>	1480/1660	<b>07.1802</b>	8200745723	•
Dokker/Lodgy (LH/RH-SX/DX)	03/12=>	1725/1940	<b>07.2021</b>	364007537R	•

**COMANDI FLESSIBILI FUNE FRENO A MANO - BRAKE CABLES - CABLES DE FREIN  
BREMSEILE - CABLES DE FRENO - CABOS DE TRAVAO  
LINKI HAMULCA - BRZDOVÁ LANKA - ТРОСЫ РУЧНОГО ТОРМОЗА**



OEM REF.







**RENAULT DACIA**

Duster 4x4 all (disc brake) (LH/RH-SX/DX)	10=>	1500/1720	<b>07.1985</b>	8200855403	0,618
Duster all (drum brake) (LH/RH-SX/DX)	10=>	1560/1785	<b>07.1986</b>	8200820595	0,640

**ROVER**

Mini Mki	=>76	1575	<b>07.777</b>	21A2224	0,116
Mini Mki Estate	=>76	1670	<b>07.776</b>	21A1706	0,119
Mini MkIII all-Clubman-Estate	76=>	1805	<b>07.956</b>	FAM2903-GVC1034	0,154
Mini MkIII all (front-avt)	76=>	640	<b>07.083</b>	GVC1035	0,046
Mini MkIII Clubman (front-avt)	76=>	740	<b>07.090</b>	FAM625	0,070
Morris-Riley-Wolseley all	63=>74	1900	<b>07.224</b>	31G1141	•
Metro all	80=>84	445x2+940/ 2075	<b>07.957</b>	GVC1033	1,000
Metro all	84=>89	445x2+1140/ 2210	<b>07.223</b>	NAM5725-GVC1027	1,001
Metro all	04/90=>	415x2+1140/ 2185	<b>07.614</b>	GVC1059	1,005
Allegro all (front-avt)	73=>82	870	<b>07.959</b>	31G5047-GVC1064	0,072
Allegro all	73=>82	830/1040	<b>07.778</b>	31G5051-GVC1001	0,325
Maestro all (front-avt)	03/83=>	630	<b>07.084</b>	NAM3608-GVC1013	0,042
Maestro all (centr.)	03/83=>	710/1400	<b>07.091</b>	NAM6474-GVC1037	0,489
Maestro all	03/83=>	345/550	<b>07.092</b>	FAM8560-GVC1032	0,129
Montego all (centr.)	03/83=>	710/1400	<b>07.091</b>	NAM6474-GVC1037	0,489
Montego all	03/83=>	345/550	<b>07.092</b>	FAM8560-GVC1032	0,129
Montego all (front-avt)	04/84=>	695	<b>07.093</b>	NAM4600-GVC1046	0,042
Montego Estate (centr.)	04/84=>	745/1460	<b>07.094</b>	NAM5604-GVC1028	0,460
Montego Estate (centr.)	04/84=>	425/610	<b>07.095</b>	NAM5603-GVC1029	0,170
100 all	04/90=>	415x2+1140/ 2185	<b>07.614</b>	GVC1059	1,005
100 all Cat. Mod.	92=>	415x2+1140/ 2185	<b>07.0297</b>	GVC1060	0,899
Acclaim (RH-DX)	81=>84	700	<b>07.096</b>	BNP2431	0,046
Acclaim (LH-SX)	81=>84	580	<b>07.181</b>	BNP2432	•
Maxi 1,5-1,7	69=>82	1525/1835	<b>07.960</b>	21H37-GVC1023	0,527
Marina 1,3-1,5-1,7-1,8	75=>80	1070/2090	<b>07.436</b>	FAM2655	0,523
213-216 all (RH-DX)	=>88	1310/1495	<b>07.0298</b>	GVC1048-GVC1039-DBP7202 DBP3674	0,651
213-216 all (LH-SX)	=>88	1310/1495	<b>07.0299</b>	GVC1047-GVC1038-DBP7203 DBP3675	0,676
214-216-218 (exc.ABS) (drum brake) (RH-DX)	89=>	1350/1530	<b>07.0185</b>	GVC1057-902357	0,550
214-216-218 (exc.ABS) (drum brake) (LH-SX)	89=>	1330/1505	<b>07.0186</b>	GVC1058-GVC1054-902358 SPB10015EVA	0,595
214-216-218 ABS (disc brake) (RH-DX)	89=>	1480/1680	<b>07.0187</b>	GVC1055-902355	0,671
214-216-218 ABS (disc brake) (LH-SX)	89=>	1455/1655	<b>07.0188</b>	GVC1056-902356	0,675
25 all (drum brake) (RH-DX)	95=>00	1495/1700	<b>07.1278</b>	GVC902387-SPB000340	0,728

**COMANDI FLESSIBILI FUNE FRENO A MANO - BRAKE CABLES - CABLES DE FREIN  
BREMSSEILE - CABLES DE FRENO - CABOS DE TRAVAO  
LINKI HAMULCA - BRZDOVÁ LANKA - ТРОСЫ РУЧНОГО ТОРМОЗА**

				OEM REF.	
<b>ROVER</b>					
25 all (drum brake) (LH-SX)	95=>00	1520/1735	<b>07.1279</b>	GVC902386-SPB000350	0,715
25 all (disc brake) (RH-DX)	95=>00	1591/1812	<b>07.1280</b>	GVC902383-SPB000370	0,755
25 all (disc brake) (LH-SX)	95=>00	1565/1782	<b>07.1281</b>	GVC902382-SPB000360	0,740
200 II all (drum brake) (RH-DX)	95=>00	1490/1713	<b>07.1278</b>	GVC902387-SPB000340	0,728
200 II all (drum brake) (LH-SX)	95=>00	1520/1735	<b>07.1279</b>	GVC902386-SPB000350	0,715
200 II all (disc brake) (RH-DX)	95=>00	1591/1812	<b>07.1280</b>	GVC902383-SPB000370	0,755
200 II all (disc brake) (LH-SX)	95=>00	1565/1782	<b>07.1281</b>	GVC902382-SPB000360	0,740
ZR105-120-160-2,0TD (drum brake) (RH-DX)	99=>	1495/1700	<b>07.1278</b>	GVC902387-SPB000340	0,728
ZR105-120-160-2,0TD (drum brake) (LH-SX)	99=>	1520/1735	<b>07.1279</b>	GVC902386-SPB000350	0,715
ZR105-120-160-2,0TD (disc brake) (RH-DX)	99=>	1591/1812	<b>07.1280</b>	GVC902383-SPB000370	0,755
ZR105-120-160-2,0TD (disc brake) (LH-SX)	99=>	1565/1782	<b>07.1281</b>	GVC902382-SPB000360	0,740
400 (5 doors) (drum brake) (LH-SX)	95=>	1345/1510	<b>07.0448</b>	GVC902376-SPB100700	0,599
400 (5 doors) (drum brake) (RH-DX)	95=>	1320/1485	<b>07.0449</b>	GVC902375	0,585
400 (5 doors) (disc brake) (RH-DX)	95=>	1469/1655	<b>07.0977</b>	GVC902388-SPB100720	•
400 (5 doors) (disc brake) (LH-SX)	95=>	1450/1630	<b>07.0978</b>	GVC902389-SPB100730 SPB101120	0,654
45 all (disc brake) (RH-DX)	95=>	1469/1655	<b>07.0977</b>	GVC902388-SPB100720	•
45 all (disc brake) (LH-SX)	95=>	1450/1630	<b>07.0978</b>	GVC902389-SPB100730 SPB101120	0,654
45-MG ZS all (drum brake)(ch. 4D633174-)(RH-DX)	06/99=>	1323/1512	<b>07.1432</b>	SPB000560	•
45-MG ZS all (drum brake)(ch. 4D633174-)(LH-SX)	06/99=>	1295/1487	<b>07.1433</b>	SPB000570	•
45-MG ZS all (disc brake) (ch. 4D632464-)(RH-DX)	06/99=>	1478/1665	<b>07.1434</b>	SPB000580	•
45-MG ZS all (disc brake) (ch. 4D632464-)(LH-SX)	06/99=>	1450/1640	<b>07.1435</b>	SPB000590	•
75 all (LH/RH-SX/DX)	99=>	1426+1426/ 1570	<b>07.1282</b>	GVC902399	0,646
75 all (ch. 3D280038-) (front-avt)	99=>	275	<b>07.1436</b>	SPB101413	•
75 all (ch. 3D280038-) (LH/RH-SX/DX)	06/01=>	1426/1570	<b>07.1437</b>	SPB000230	•
414-416-418 (exc.ABS) (drum brake) (RH-DX)	89=>	1350/1530	<b>07.0185</b>	GVC1057-902357	0,550
414-416-418 (exc.ABS) (drum brake) (LH-SX)	89=>	1330/1505	<b>07.0186</b>	GVC1058-GVC1054-902358 SPB10015EVA	0,595
414-416-418 ABS (disc brake) (RH-DX)	89=>	1480/1680	<b>07.0187</b>	GVC1055-902355	0,671
414-416-418 ABS (disc brake) (LH-SX)	89=>	1455/1655	<b>07.0188</b>	GVC1056-902356	0,675
600 series (LH-SX)	93=>	1640/1870	<b>07.0219</b>	GVC902372	0,784
600 series (RH-DX)	93=>	1640/1870	<b>07.0220</b>	GVC902371	0,782
820 all (RH-DX)	11/88=>	1815	<b>07.0718</b>	GVC1049-902149	•
820 all (LH-SX)	11/88=>	1875	<b>07.0719</b>	GVC1052-902152	1,092
<b>LANDROVER</b>					
Freelander 1,8 all (RH-DX)	97=>	1286/1568	<b>07.0979</b>	SPB101300	0,662
Freelander 1,8 all (LH-SX)	97=>	1286/1568	<b>07.0980</b>	SPB101301	0,665
Freelander II all (LH-SX)	06=>	1294/1578	<b>07.1911</b>	LR008807-LR001032	•
Freelander II all (RH-DX)	06=>	1292/1573	<b>07.1912</b>	LR007496-LR001031	•
Defender 110 inc. Van	90=>95	927/1124	<b>07.0981</b>	NTC3480	•
Defender 90-110 2,5-3,5 D-TD	83=>90	1150	<b>07.0721</b>	NRC5089	0,523

**COMANDI FLESSIBILI FUNE FRENO A MANO - BRAKE CABLES - CABLES DE FREIN  
BREMSSEILE - CABLES DE FRENO - CABOS DE TRAVAO  
LINKI HAMULCA - BRZDOVÁ LANKA - ТРОСЫ РУЧНОГО ТОРМОЗА**

				<b>OEM REF.</b>	
---	---	---	--	-----------------	---





<b>LANDROVER</b>					
Discovery 2,0-3,5-3,9-2,5 TD	90=>	1012/1194	<b>07.0982</b>	NTC9400	0,490
Land Rover 90-110	83=>90	1150	<b>07.0721</b>	NRC5089	0,523
Range Rover 2,4-2,5 TD-3,5i	86=>89	1150	<b>07.0721</b>	NRC5089	0,523
Range Rover 3,9i	89=>	1070	<b>07.0723</b>	NRC4329	0,875
Range Rover Vogue (L322) (exc. Sport) (RHD mod.) (LH-SX)	02=>	1230/1850	<b>07.1991</b>	SPB000073	0,536
Range Rover L322-Vogue all (exc. Sport) (RH-DX)	07=>	1200/1845	<b>07.1810</b>	SPB000043	•
Range Rover L322-Vogue all (exc. Sport) (LH-SX)	07=>	1230/1878	<b>07.1811</b>	SPB000053	•
SD1 all 2,0-2,6-3,5 D	77=>87	1540+1170/ 1925	<b>07.0311</b>	CRC2701	•



<b>LANDROVER - Commercial Vehicle</b>					
Sherpa LWB (front-avt)	82=>	1103	<b>07.0510</b>	AAR1246	0,150
LDV 300/400 LWB (front-avt)	89=>96	1103	<b>07.0510</b>	AAR1246	0,150

<b>SAAB</b>					
95-95 V4-96-96 V4	56=>	850/1890	<b>07.865</b>	7199227	0,449
99 all (LH/RH-SX/DX)	69=>74	1550/1755	<b>07.600</b>	8927700-890801	0,591
99 all (LH/RH-SX/DX)	75=>80	1670/1890	<b>07.599</b>	8927816	0,595
900 all (LH/RH-SX/DX)	79=>	1690/1920	<b>07.979</b>	8937898	0,925
900 all (LH/RH-SX/DX)	88=>	1500/1650	<b>07.513</b>	9101445	0,532
900 Spyder (LH/RH-SX/DX)	88=>91	1485/1645	<b>07.669</b>	9014134	0,591
900 all (LH-SX)	91=>	600+870/ 1630	<b>07.0312</b>	4105789	0,740
900 all (RH-DX)	91=>	600+890/ 1650	<b>07.0313</b>	9196163	0,754
900 SE all (LH-SX)	93=>	780	<b>07.0319</b>	4241311	0,071
900 SE all (RH-DX)	93=>	1240/2105	<b>07.0320</b>	4241329	0,548
900 SE all	94=>	859/1435+ 1612/2178	<b>07.0987</b>	4543104	1,166
900 all	94=>	860/1420+ 1380/2180	<b>07.1543</b>	4839874	1,153
9000 all (LH-SX)	=>86	1640/2040	<b>07.514</b>	8964348	0,632
9000 all (RH-DX)	=>86	1490/1885	<b>07.516</b>	8964363	0,683
9000 all (LH-SX)	87=>	1645/2040	<b>07.517</b>	8967481	0,641
9000 all (RH-DX)	87=>	1520/1905	<b>07.518</b>	8967499	0,611
9000 all (RH-DX)	88=>	1570/1910	<b>07.519</b>	8970733	0,613
9-3	98=>	860/1420+ 1380/2180	<b>07.1543</b>	4839874	1,153
9-5	98=>05	340	<b>07.1439</b>	4905980	•
9-5 all (LH/RH-SX/DX)	98=>05	859/1435+ 940/1410	<b>07.1440</b>	4908356-5059829	1,159

**COMANDI FLESSIBILI FUNE FRENO A MANO - BRAKE CABLES - CABLES DE FREIN  
BREMSSEILE - CABLES DE FRENO - CABOS DE TRAVAO  
LINKI HAMULCA - BRZDOVÁ LANKA - ТРОСЫ РУЧНОГО ТОРМОЗА**

				OEM REF.	
<b>SEAT</b>					
133 all		280+280/ 1580	<b>07.113</b>	EA 16735800	0,340
Panda	=>86	1035+1035/ 2690	<b>07.676</b>	XO 4406021	0,848
Marbella all	86=>	1035+1035/ 2690	<b>07.676</b>	SE 141167358 A	0,848
127-Fura all		845+845/ 2315	<b>07.117</b>	HB 16735800	0,736
Arosa all (LH/RH-SX/DX)	97=>	800/1395	<b>07.0754</b>	6X0609721C-6X0609721F	0,307
Arosa all ABS (LH/RH-SX/DX)	98=>	975/1505	<b>07.0755</b>	6X0609721D	0,339
124 all	=>77	760+760/ 2200	<b>07.126</b>	4144494-4153287-FA1673580	0,653
124 D-LS all	78=>	800+800/ 2465	<b>07.844</b>	FL16735800	0,702
Ritmo all (front-avt)	03/83=>	890	<b>07.535</b>	4403012-RF16731500	0,217
Ritmo all	03/83=>	805+805/ 2165	<b>07.536</b>	RF16732000	0,688
Mii all	12=>	825/1520	<b>07.2024</b>	1S0609721C	•
Ibiza all (front-avt)	04/83=>	925	<b>07.524</b>	SE022167315A-X039607270 SE022167316A	0,092
Ibiza	04/83=>	800+800/ 2290	<b>07.138</b>	SE022167320A	0,712
Ibiza (drum brake) (LH/RH-SX/DX)	93=>94	945/1505	<b>07.0322</b>	6K0609721	0,386
Ibiza (drum brake) (LH/RH-SX/DX)	94=>	945/1530	<b>07.0323</b>	6K0609721C	0,393
Ibiza (disc brake) (LH/RH-SX/DX)	93=>94	1050/1600	<b>07.0324</b>	6K0609721A-6K0609721B	0,456
Ibiza (disc brake) (LH/RH-SX/DX)	94=>	1050/1600	<b>07.0543</b>	6K0609721D	0,473
Ibiza (disc brake) (LH/RH-SX/DX)	96=>	1130/1625	<b>07.0544</b>	6K0609721E-6K0609721F	0,390
Ibiza (drum brake) (LH/RH-SX/DX)	99=>	954/1531	<b>07.0757</b>	6N0609721K	0,354
Ibiza (disc brake) (LH/RH-SX/DX)	99=>	1132/1641	<b>07.0989</b>	6N0609721M-6N0609721H	0,415
Ibiza all (disc brake) (LH/RH-SX/DX)	06/06=>	1045/1640	<b>07.1658</b>	6Q0609721K	0,404
Ibiza all (disc brake) (LH/RH-SX/DX)	06/08=>	1045/1640	<b>07.1812</b>	6R0609721C	•
Ibiza all (drum brake) (LH/RH-SX/DX)	06/08=>	935/1590	<b>07.1813</b>	6R0609721B	•
Cordoba (drum brake) (LH/RH-SX/DX)	93=>94	945/1505	<b>07.0322</b>	6K0609721	0,386
Cordoba (drum brake) (LH/RH-SX/DX)	94=>	945/1530	<b>07.0323</b>	6K0609721C	0,393
Cordoba (disc brake) (LH/RH-SX/DX)	93=>94	1050/1600	<b>07.0324</b>	6K0609721A-6K0609721B	0,456
Cordoba (disc brake) (LH/RH-SX/DX)	94=>	1050/1600	<b>07.0543</b>	6K0609721D	0,473
Cordoba (disc brake) (LH/RH-SX/DX)	96=>	1130/1625	<b>07.0544</b>	6K0609721E-6K0609721F	0,390
Cordoba (drum brake) (LH/RH-SX/DX)	99=>	954/1531	<b>07.0757</b>	6N0609721K	0,354
Cordoba (disc brake) (LH/RH-SX/DX)	99=>	1132/1641	<b>07.0989</b>	6N0609721M-6N0609721H	0,415
Malaga	04/83=>	800+800/ 2290	<b>07.138</b>	SE022167320A	0,712
Malaga all (front-avt)	04/83=>	925	<b>07.524</b>	SE022167315A-X039607270 SE022167316A	0,092
Ronda all	78=>	805+805/ 2165	<b>07.536</b>	RF 16732000	0,688
Ronda	04/83=>	800+800/ 2290	<b>07.138</b>	SE022167320A	0,712

**COMANDI FLESSIBILI FUNE FRENO A MANO - BRAKE CABLES - CABLES DE FREIN  
BREMSSEILE - CABLES DE FRENO - CABOS DE TRAVAO  
LINKI HAMULCA - BRZDOVÁ LANKA - ТРОСЫ РУЧНОГО ТОРМОЗА**

				<b>OEM REF.</b>	
---	---	---	--	-----------------	---

<b>SEAT</b>					
Ronda all (front-avt)	04/83=>	925	<b>07.524</b>	SE022167315A-X039607270 SE022167316A	0,092
Leon all (LH/RH-SX/DX)	98=>	820/1055	<b>07.0410</b>	1J0609721E	0,392
Leon all (LH/RH-SX/DX)	00=>	1070/1700	<b>07.0991</b>	1J0609721AC-1J0609721AD 1J0609721K-1J0609721T	0,372
Leon all (LH/RH-SX/DX)	10/03=>	805/1443	<b>07.1442</b>	1K0609721AA-1K0609721S 1K0609721T	0,388
Toledo (disc brake) (LH/RH-SX/DX)	91=>	1230/1620	<b>07.289</b>	1L0609721A-1L0609721B 191609721F	0,509
Toledo (drum brake) (LH/RH-SX/DX)	91=>	1085/1530	<b>07.287</b>	191609721E	0,429
Toledo all (LH/RH-SX/DX)	98=>	820/1055	<b>07.0410</b>	1J0609721E	0,392
Toledo all (LH/RH-SX/DX)	00=>	1070/1700	<b>07.0991</b>	1J0609721AC-1J0609721AD 1J0609721K-1J0609721T	0,372
Altea all (LH/RH-SX/DX)	10/03=>	805/1443	<b>07.1442</b>	1K0609721AA-1K0609721S 1K0609721T	0,388
Altea all (LH/RH-SX/DX)	04=>	810/1450	<b>07.1441</b>	1K0609721Q	0,366
Alhambra all (interm.)	96=>	655	<b>07.0637</b>	1013482-7M0711472A	0,053
Alhambra all (LH/RH-SX/DX)	96=>	1135/1295	<b>07.0638</b>	7M0609701B-95VW2A603AC	0,524
Alhambra 7V8-7V9-1,8T 20v-1,9Tdi-1,9Tdi motion-2,8V6 24v-2,8V6 motion (LH/RH-SX/DX)	97=>01	1155/1320	<b>07.1783</b>	1109023-7M3609701 7M3609701D	•



**SEAT - Commercial Vehicle**

Terra all	86=>	1270+1270/ 3170	<b>07.284</b>	SE024167358A	1,038
Inca all (LH/RH-SX/DX)	96=>	1130/1670	<b>07.0767</b>	6K9609721	0,525

**SKODA**

S105 all (LH/RH-SX/DX)		1200/1480	<b>07.0732</b>	113332752	0,400
S110 (LH/RH-SX/DX)	=>76	1075/1330	<b>07.605</b>	111332750	0,366
S110 (LH/RH-SX/DX)	77=>	1220/1485	<b>07.672</b>	113332750-113332751	0,411
S120 all (LH/RH-SX/DX)		1200/1480	<b>07.0732</b>	113332752	0,400
Citigo	12=>	825/1520	<b>07.2024</b>	1S0609721C	•
Favorit all (LH/RH-SX/DX)	89=>	1480/1775	<b>07.526</b>	115332750-115332751	0,465
Felicia all (LH/RH-SX/DX)	89=>	1480/1775	<b>07.526</b>	115332750-115332751	0,465
Felicia all (LH/RH-SX/DX)	12/92=>	1450/1755	<b>07.0731</b>	115520117	0,531
Felicia Pick-Up (LH/RH-SX/DX)	12/92=>	1470/1780	<b>07.1544</b>	6U7609721	0,561
Fabia all (drum brake) (LH/RH-SX/DX)	99=>	925/1580	<b>07.0992</b>	6Q0609721B-6Q0609721H 6Q0609721M-6Q0609721N	0,340
Fabia Cross (drum brake) (LH/RH-SX/DX)	06/06=>	925/1580	<b>07.0992</b>	6Q0609721M	0,340





**COMANDI FLESSIBILI FUNE FRENO A MANO - BRAKE CABLES - CABLES DE FREIN  
BREMSSEILE - CABLES DE FRENO - CABOS DE TRAVAO  
LINKI HAMULCA - BRZDOVÁ LANKA - ТРОСЫ РУЧНОГО ТОРМОЗА**

				OEM REF.	
<b>SKODA</b>					
Fabia (disc brake) (LH/RH-SX/DX)	99=>	1043/1640	<b>07.0993</b>	6Q0609721C-6Q0609721F 6Q0609721G-6Q0609721L	0,356
Fabia all (disc brake) (LH/RH-SX/DX)	07=>	1045/1640	<b>07.1658</b>	6Q0609721K	0,404
Roomster all (drum brake) (LH/RH-SX/DX)	07=>	945/1800	<b>07.1659</b>	6Q0609721C-6Q0609721E	0,363
Roomster all (disc brake) (LH/RH-SX/DX)	07=>	1070/1882	<b>07.1660</b>	6Q7609721C-6Q7609721E	•
Octavia all (disc brake) (LH/RH-SX/DX)	96=>	820/1055	<b>07.0410</b>	1J0609721E	0,392
Octavia all (LH/RH-SX/DX)	00=>	1070/1700	<b>07.0991</b>	1J0609721K	0,372
Octavia all (LH/RH-SX/DX)	01=>	1070/1700	<b>07.0991</b>	1J0609721AC	0,372
Octavia all (drum brake) (LH/RH-SX/DX)	96=>03	944/1620	<b>07.1284</b>	1J0609721J-1J0609721S	0,449
Octavia all (drum brake) (LH/RH-SX/DX)	98=>	940/1620	<b>07.1285</b>	1J0609721D	0,433
Octavia all (LH/RH-SX/DX)	03=>	810/1450	<b>07.1441</b>	1K0609721Q	0,366
Octavia all (RH-DX)	10/03=>	805/1443	<b>07.1442</b>	1K0609721T	0,388
Octavia all (drum brake) (LH/RH-SX/DX)	=>03	940/1620	<b>07.1444</b>	1J0609721D-1J0609721G	•
Superb all (LH-SX)	02=>	1815/1985	<b>07.1446</b>	3BD609721C	1,017
Superb all (RH-DX)	02=>	1820/1985	<b>07.1447</b>	3BD609722C	1,027
Superb all (LH/RH-SX/DX)	03/08=>	780/1585	<b>07.1936</b>	3T0609721	•







<b>SUBARU</b>					
Forester (LH-SX)	97=>06	1340/1605	<b>07.1745</b>	26051FC030	•
Forester (RH-DX)	97=>06	1321/1590	<b>07.1746</b>	26051FC020	•

<b>SUZUKI</b>					
Alto SS/40	82=>86	1110+1110/ 2620	<b>07.0066</b>	5441078020-5441081110	0,683
Alto all (RH-DX)	02=>	1263/1472	<b>07.1747</b>	54401M79G10	0,569
Alto all (LH-SX)	02=>	1268/1477	<b>07.1748</b>	54402M79G00	0,598
Alto all (LH/RH-SX/DX)	97=>81	1364+1379/ 3135	<b>07.1627</b>	54400M70F10	1,166
Alto all (RH-DX)	10=>	1224/1440	<b>07.1967</b>	54401M68K00	0,560
Alto all (LH-SX)	10=>	1238/1455	<b>07.1968</b>	54402M68K00	0,580
Splash all (LH-SX)	08=>	1380/1600	<b>07.1875</b>	5440151K00	0,677
Splash all (RH-DX)	08=>	1385/1600	<b>07.1876</b>	5440251K00	0,677
Ignis all (RH-DX)	02=>	1276/1523	<b>07.1451</b>	5441086G00	•
Ignis all (LH-SX)	02=>	1285/1532	<b>07.1452</b>	5442086G00	0,672
Wagon R all (RH-DX)	99=>	1291/1507	<b>07.1039</b>	5441083E20-5440178F02	0,502
Wagon R all (LH-SX)	99=>	1302/1505	<b>07.1449</b>	5442083E00	0,600
Wagon R all (LH-SX)	99=>	1294/1510	<b>07.1450</b>	5440278F10-5440278F11	•
Wagon R all (exc.4WD) (LH/RH-SX/DX)	00=>	1390+1410/ 3180	<b>07.1814</b>	5440075F00	•
Wagon R all (LH/RH-SX/DX)	00=>	1380+1420/ 3185	<b>07.1815</b>	5440075F10	•
Wagon R II (LH-SX)	03=>	1290/1530	<b>07.1236</b>	4706689-9211156-5442084E00	0,683
Wagon R II (RH-DX)	03=>	1281/1530	<b>07.1237</b>	4706688-9211155-5441084E00	0,563
Granvitara all (3 doors) (RH-DX)	98=>05	1145/1390	<b>07.1749</b>	5441065D00	0,570
Granvitara all (3 doors) (LH-SX)	98=>05	1098/1336	<b>07.1750</b>	5442065D00	0,545
Granvitara all (5 doors) (LH-SX)	98=>05	1385/1628	<b>07.1751</b>	5442065D10	0,621

**COMANDI FLESSIBILI FUNE FRENO A MANO - BRAKE CABLES - CABLES DE FREIN  
BREMSEILE - CABLES DE FRENO - CABOS DE TRAVAO  
LINKI HAMULCA - BRZDOVÁ LANKA - ТРОСЫ РУЧНОГО ТОРМОЗА**





				OEM REF.	
<b>SUZUKI</b>					
Granvitara all (5 doors) (RH-DX)	98=>05	1337/1575	<b>07.1752</b>	5441065D10	•
Swift all (3 doors) (LH/RH-SX/DX)	89=>	1190/1375	<b>07.0325</b>	5440060B00	0,440
Swift all (5 doors) (LH/RH-SX/DX)	89=>	1285/1435	<b>07.0326</b>	5440062B00	0,656
Swift GTI	89=>	1135/1330	<b>07.0327</b>	5440064B00	0,598
Swift all (RH-DX)	05=>	1395/1625	<b>07.1992</b>	5440162J00	1,393
Swift all (LH-SX)	05=>	1395/1625	<b>07.1993</b>	5440262J00	1,393
Santana SJ410/413 (Japan mod.) (LH/RH-SX/DX)		1060/1270	<b>07.0067</b>	54640A80010-54640A80011	0,312
Santana SJ410/413 (RH-DX)	=>89	785/1015	<b>07.0328</b>	54640A70A00	0,246
Santana SJ410/413 (LH-SX)	=>89	785/1030	<b>07.0329</b>	54660A83310	0,318
Santana SJ410/413 (long body) (RH-DX)	=>89	985/1240	<b>07.0330</b>	54640A70A10	0,296
Santana SJ410/413 (long body) (LH-SX)	=>89	1065/1315	<b>07.0331</b>	54681A83600	0,294
Samurai SJ410/413 (RH-DX)	=>89	785/1015	<b>07.0328</b>	54640A70A00	0,246
Samurai SJ410/413 (LH-SX)	=>89	785/1030	<b>07.0329</b>	54660A83310	0,318
Samurai SJ410/413 (long body) (RH-DX)	=>89	985/1240	<b>07.0330</b>	54640A70A10	0,296
Samurai SJ410/413 (long body) (LH-SX)	=>89	1065/1315	<b>07.0331</b>	54681A83600	0,294
Samurai SJ413 Sedan all (LH/RH-SX/DX)	90=>	1175/1340	<b>07.0332</b>	4504000000-4504100000	0,414
Samurai SJ413 Sedan ie (RH-DX)	90=>	1275/1445	<b>07.0333</b>	4506800000-4506884C00	0,485
Samurai SJ413 SW (long body) (RH-DX)	90=>	1395/1565	<b>07.0334</b>	4504800000	0,467
Samurai SJ413 all (LH-SX)	98=>	1165/1345	<b>07.1753</b>	4509684C00	0,475
Vitara all (3 doors) (Girling Brake) (RH-DX)	90=>	1190/1400	<b>07.0336</b>	54410A60A01	0,443
Vitara all (3 doors) (Girling Brake) (LH-SX)	90=>	1135/1345	<b>07.0337</b>	54420A60A01	0,459
Vitara all (3 doors) (RH-DX)	90=>	1170/1398	<b>07.0733</b>	54410A60A60	0,552
Vitara all (3 doors) (LH-SX)	90=>	1115/1345	<b>07.0734</b>	54420A60A60	0,534
Vitara all (5 doors) (LH-SX)	90=>	1420/1630	<b>07.0735</b>	5442056B60	0,632
Vitara all (5 doors) (RH-DX)	90=>	1475/1685	<b>07.0736</b>	5441056B60	0,656
Baleno all (3 doors) (drum brake) (RH-DX)	99=>	1285/1499	<b>07.0994</b>	5440162G00	0,550
Baleno all (3 doors) (drum brake) (LH-SX)	99=>	1340/1550	<b>07.0995</b>	5440264GA0	0,587
Baleno all (4/5 doors) (drum brake) (RH-DX)	99=>	1356/1572	<b>07.0996</b>	5440160G00	0,568
Baleno all (4/5 doors) (drum brake) (LH-SX)	99=>	1442/1656	<b>07.0997</b>	5440264G00	0,648
Baleno all (4/5 doors) (disc brake) (RH-DX)	99=>	1271/1475	<b>07.0998</b>	5440160G10	0,527
Baleno all (4/5 doors) (disc brake) (LH-SX)	99=>	1352/1557	<b>07.0999</b>	5440260G10	0,565
Jimny (RH-DX)	00=>	1375/1588	<b>07.1001</b>	5441081A01-5441081A00	0,622
Jimny (LH-SX)	00=>	1370/1570	<b>07.1002</b>	5442081A01	•
SX4 all (RH-DX)		1565/1795	<b>07.1498</b>	5440179J00000	•
SX4 all (LH-SX)		1555/1785	<b>07.1499</b>	5440279J00000	•
SX4 all (disc brake) (RH-DX)	06=>	1455/1635	<b>07.2004</b>	5440155L10000	•
SX4 all (disc brake) (LH-SX)	06=>	1455/1635	<b>07.2005</b>	5440255L1000	•
<b>TALBOT</b>					
1000	61=>	760+760/ 2260	<b>07.439</b>	54783300-22264Y	0,507
Horizon all	78=>	665+665/ 3060	<b>07.816</b>	52152860-57388G	0,529

**COMANDI FLESSIBILI FUNE FRENO A MANO - BRAKE CABLES - CABLES DE FREIN  
BREMSSEILE - CABLES DE FRENO - CABOS DE TRAVAO  
LINKI HAMULCA - BRZDOVÁ LANKA - ТРОСЫ РУЧНОГО ТОРМОЗА**





				OEM REF.	
<b>TALBOT</b>					
1307-1308-1510/Solara all	75=>	660+660/ 3230	<b>07.539</b>	17090300-48096W	0,581
Rancho	77=>	605+605/ 3000	<b>07.871</b>	13216400	0,567
Samba all (LH/RH-SX/DX)	81=>	705/1385	<b>07.885</b>	97501753-97501780	0,331
 					
<b>TALBOT - Commercial Vehicle</b>					
Express Van LWB (front-avt)	81=>	2445/2630	<b>07.067</b>	5970619-474558	0,969
Express Van SWB (front-avt)	81=>	1650/1890	<b>07.478</b>	474557	0,697
Express Van	81=>	715+715/ 2590	<b>07.796</b>	483476	0,554
<b>TALBOT UK - CHRYSLER - HILMAN (UK)</b>					
Sunbeam 1,0-1,1	76=>	1040/1485	<b>07.769</b>	20325100	0,453

<b>TOYOTA</b>					
Aygo all (LH-SX)	05=>	1243/1486	<b>07.1338</b>	464300H010-4745Y3	0,536
Aygo all (RH-DX)	05=>	1235/1478	<b>07.1454</b>	464200H010-4745Y2	0,544
Yaris all (LH-SX)	99=>	1310/1502	<b>07.1003</b>	4643052010	0,555
Yaris all (RH-DX)	99=>	1355/1545	<b>07.1004</b>	4642052010	0,535
Yaris all (drum brake) (RH-DX)	00=>	1363/1600	<b>07.1553</b>	464200D050	0,529
Yaris all (drum brake) (LH-SX)	00=>	1320/1556	<b>07.1554</b>	464300D050	•
Yaris Verso all (LH-SX)	00=>02	1495/1686	<b>07.1005</b>	4643052050	0,575
Yaris Verso all (RH-DX)	00=>02	1435/1625	<b>07.1006</b>	4642052050	0,573
Yaris Verso all (LH-SX)	02=>	1390/1520	<b>07.1289</b>	4643052080	0,548
Yaris Verso all (RH-DX)	02=>	1345/1475	<b>07.1290</b>	4642052080	0,524
Yaris F all (disc brake) (LH-SX)	02=>	1377/1582	<b>07.1455</b>	464300D010	0,529
Yaris F all (disc brake) (RH-DX)	02=>	1347/1552	<b>07.1456</b>	464200D010	•
Yaris Verso all (disc brake) (LH-SX)	02=>	1511/1685	<b>07.1457</b>	4643052070	0,578
Yaris Verso all (disc brake) (RH-DX)	02=>	1470/1602	<b>07.1458</b>	4642052070	•
Yaris all (disc brake) (RH-DX)	02=>	1511/1685	<b>07.1551</b>	464200D060	0,564
Yaris all (disc brake) (LH-SX)	02=>	1468/1642	<b>07.1552</b>	464300D060	0,610
Yaris J II 1,8 VVTi (LH-SX)	06=>	1430/1620	<b>07.2029</b>	4643052161	•
Yaris J II 1,8 VVTi (RH-DX)	06=>	1475/1665	<b>07.2030</b>	4642052161	•
Yaris J all (ch. 200508-) (drum brake) (RH-DX)	06=>11	1395/1600	<b>07.2031</b>	4642052151	•
Yaris J all (ch. 200508-) (drum brake) (LH-SX)	06=>11	1350/1560	<b>07.2032</b>	4643052151	•
Starlet (front-avt)	78=>84	300	<b>07.0068</b>	4641020210-4641002040 4641020230-4641020300 4641010030-4641012160 4641012210-94857010	0,034
Starlet (front-avt)	84=>	245	<b>07.0255</b>	4641010050	0,035
Starlet (LH-SX)	78=>84	770/1325	<b>07.904</b>	4643010060-4643010061	0,353
Starlet (RH-DX)	78=>84	750/1295	<b>07.905</b>	4642010070-4642010071	0,314
Starlet (LH-SX)	84=>	1230/1515	<b>07.0260</b>	4643010070	0,525
Starlet (RH-DX)	84=>	1240/1525	<b>07.0265</b>	4642010080	0,548

**COMANDI FLESSIBILI FUNE FRENO A MANO - BRAKE CABLES - CABLES DE FREIN  
BREMSSEILE - CABLES DE FRENO - CABOS DE TRAVAO  
LINKI HAMULCA - BRZDOVÁ LANKA - ТРОСЫ РУЧНОГО ТОРМОЗА**

				OEM REF.	
<b>TOYOTA</b>					
Starlet all (front-avt)	96=>	260	<b>07.1459</b>	4641042010	0,033
Starlet all (LH-SX)	96=>	1177/1484	<b>07.1460</b>	4643018030	•
Starlet all (RH-DX)	96=>	1203/1518	<b>07.1461</b>	4642018030	•
Auris all (front-avt)	10/06=>	335	<b>07.1816</b>	4641012280	0,032
Auris I all (front-avt)	02/07=>	345	<b>07.2047</b>	4641002090	•
Prius all (LH-SX)	03=>09	1515/1775	<b>07.1914</b>	4643047060	0,545
Prius all (RH-DX)	03=>09	1455/1715	<b>07.1915</b>	4642047060	0,582
Corolla KE20 (LH/RH-SX/DX)	70=>79	820/1300	<b>07.901</b>	4642012051	0,373
Corolla (front-avt)	72=>77	280	<b>07.0064</b>	4641014020-4641016020	0,038
Corolla KE30 (RH-DX)	75=>	850/1230	<b>07.903</b>	4642012090-4642012091	0,370
Corolla KE70 (LH-SX)	80=>	835/1330	<b>07.0069</b>	4643012110-4643012111	0,383
Corolla KE70 (RH-DX)	80=>	735/1320	<b>07.0070</b>	4642012210-4642012211	0,369
Corolla KE70 SW (LH-SX)	80=>	900/1315	<b>07.0071</b>	4643013010-4643013011	0,385
Corolla KE70 SW (RH-DX)	80=>	885/1300	<b>07.0072</b>	4642013010-4642013011	•
Corolla TE72 1,8 (LH-SX)	80=>	840/1355	<b>07.0073</b>	4643012130	0,397
Corolla TE72 1,8 (RH-DX)	80=>	735/1340	<b>07.0074</b>	4642012230	0,347
Corolla KE 30 (front-avt)	80=>83	280	<b>07.0065</b>	4641012070	0,036
Corolla AE 80-CE 80 (front-avt)	08/83=>	300	<b>07.0068</b>	4641020210-4641002040 4641020230-4641020300 4641010030-4641012160 4641012210-94857010	0,034
Corolla AE80-82 (front-avt)	83=>87	310	<b>07.0554</b>	4641012150-4641020420	0,036
Corolla AE80-82 (LH-SX)	83=>87	1150/1480	<b>07.0075</b>	4643012210-4642012310	0,564
Corolla AE82 GT-FX	85=>88	1336/1985	<b>07.1288</b>	4642012330	•
Corolla CE70 Van D (LH-SX)	83=>85	900/1330	<b>07.0338</b>	4643013031	0,340
Corolla CE70 Van D (RH-DX)	83=>85	890/1320	<b>07.0339</b>	4642013031	0,377
Corolla AE90-CE90 (LH-SX)	87=>	1250/1570	<b>07.0077</b>	4643012240	0,549
Corolla AE90-CE90 (RH-DX)	87=>	1245/1560	<b>07.0078</b>	4642012340	0,594
Corolla AE92 GT (LH-SX)	87=>91	1190/1440	<b>07.0555</b>	4643012260	0,493
Corolla AE92 GT (RH-DX)	87=>91	1180/1430	<b>07.0556</b>	4642012360	0,489
Corolla AE95 4WD (LH-SX)	87=>95	882/1447	<b>07.1286</b>	4643012281	•
Corolla AE95 4WD (RH-DX)	87=>95	798/1468	<b>07.1287</b>	4642012371-4642012200	•
Corolla AE100/101-CE100-EE100/101 (LH-SX)	91=>	1290/1585	<b>07.0552</b>	4643012300-4643002040	0,617
Corolla AE100/101-CE100-EE100/101 (RH-DX)	91=>	1310/1600	<b>07.0553</b>	4642012400-4642002040	0,311
Corolla AE100/101-CE100-EE100/101 (front-avt)	91=>93	360	<b>07.1464</b>	4641012190	0,037
Corolla AE101-GT all (LH-SX)	91=>95	1215/1450	<b>07.1822</b>	4643012290	•
Corolla AE100/101-CE100-EE100/101-Corolla Corolla Sedan SW (front-avt)-Geo Prizm Lsi	91=> 98=>	300	<b>07.0068</b>	4641020210-4641002040 4641020230-4641020300 4641010030-4641012160 4641012210-94857010	0,034
Corolla AE101-GT all (RH-DX)	99=>01	1218/1460	<b>07.1821</b>	4642012390	0,502
Corolla Kombi 4WD (LH-SX)	95=>01	1245/1538	<b>07.1462</b>	4643012380	•
Corolla Kombi 4WD (RH-DX)	95=>01	1250/1552	<b>07.1463</b>	4642012480	•
Corolla E11 LiftBack all (RH-DX)	99=>01	1218/1460	<b>07.1821</b>	4642012390	0,502
Corolla E11 LiftBack all (LH-SX)	99=>01	1215/1450	<b>07.1822</b>	4643012290	•
Corolla E11 Compact/LiftBack (disc brake)(RH-DX)	99=>01	1185/1440	<b>07.1820</b>	4642012470	•
Corolla III 1,4 VVTi 1,6/1,9 16v (Europa mod.) (RH-DX)	10/99=>10/01	1275/1580	<b>07.1995</b>	4642012710-4642002050	•
Corolla all (front-avt)	11/01=>	398	<b>07.1465</b>	4641012270	0,045
Corolla Verso (front-avt)	11/01=>	276	<b>07.1466</b>	464100F010	0,031





**COMANDI FLESSIBILI FUNE FRENO A MANO - BRAKE CABLES - CABLES DE FREIN  
BREMSSEILE - CABLES DE FRENO - CABOS DE TRAVAO  
LINKI HAMULCA - BRZDOVÁ LANKA - ТРОСЫ РУЧНОГО ТОРМОЗА**

				OEM REF.	
<b>TOYOTA</b>					
Corolla all ZZE120-12 (RH-DX)	11/01=>	1500/1688	<b>07.1632</b>	4642012490	•
Corolla all ZZE120-12 (LH-SX)	11/01=>	1425/1615	<b>07.1633</b>	4643012400	0,531
Corolla Verso II all (RH-DX)	03/04=>	1770/1985	<b>07.2048</b>	464200F010	•
Corolla Verso II all (LH-SX)	03/04=>	1720/1930	<b>07.2049</b>	464300F010	•
Corolla (E12) HatchBack-SW (LH-SX)	06/04=>09/06	1395/1640	<b>07.1819</b>	4643012441-4643002090 464300211	•
Corolla (E12) HatchBack-SW (RH-DX)	06/04=>09/06	1453/1698	<b>07.1849</b>	4642012541-4642002090 464200211	•
Tercel (LH-SX)	79=>82	1180/1455	<b>07.906</b>	4643016011	0,509
Tercel (RH-DX)	79=>82	1175/1450	<b>07.907</b>	4642016020	0,506
Tercel (LH-SX)	82=>	1255/1545	<b>07.0079</b>	4643016040	0,509
Tercel (RH-DX)	82=>	1240/1530	<b>07.0080</b>	4642016040	0,530
Tercel (LH-SX)	79=>82	1180/1455	<b>07.906</b>	4643016011	0,509
Tercel (RH-DX)	79=>82	1175/1450	<b>07.907</b>	4642016020	0,506
Tercel (LH-SX)	82=>	1255/1545	<b>07.0079</b>	4643016040	0,509
Tercel (RH-DX)	82=>	1240/1530	<b>07.0080</b>	4642016040	0,530
Tercel AL25-4WD (LH-SX)	07/82=>	860/1445	<b>07.0081</b>	4643016060	0,389
Tercel AL25-4WD (RH-DX)	07/82=>	745/1425	<b>07.0082</b>	4642016060B	0,361
Carina (LH-SX)	70=>76	830/1465	<b>07.908</b>	4643014020	0,374
Carina (LH-SX)	76=>78	800/1400	<b>07.0084</b>	4643014021	0,391
Carina (RH-DX)	76=>78	780/1380	<b>07.0151</b>	4642014021	0,345
Carina (LH-SX)	78=>	890/1835	<b>07.0094</b>	4643014070	0,427
Carina (RH-DX)	78=>	815/1025	<b>07.0095</b>	4642014070	0,384
Carina SW (RH-DX)	78=>80	615/795	<b>07.0153</b>	4642015050	0,315
Carina SW (LH-SX)	78=>80	920/1340	<b>07.0096</b>	4643014200	0,382
Carina SW (LH-SX)	82=>	890/1415	<b>07.0083</b>	4643014210	0,429
Carina SW (RH-DX)	82=>	800/1400	<b>07.0084</b>	4642014170	0,391
Carina (front-avt)	83=>85	300	<b>07.0068</b>	4641020210-4641002040 4641020230-4641020300 4641010030-4641012160 4641012210-94857010	0,034
Carina (LH/RH-SX/DX)	83=>85	1180/1570	<b>07.0086</b>	4643029015-4642039015	0,503
Carina II all (front-avt)	85=>87	300	<b>07.0068</b>	4641020210-4641002040 4641020230-4641020300 4641010030-4641012160 4641012210-94857010	0,034
Carina II (AT151) (LH/RH-SX/DX)	85=>87	1180/1570	<b>07.0088</b>	4643029016-4642039016	0,580
Carina II (AT171-CT170-ST171) (front-avt)	88=>92	300	<b>07.0068</b>	4641020210-4641002040 4641020230-4641020300 4641010030-4641012160 4641012210-94857010	0,034
Carina II (AT171) 1,6-D (drum brake) (LH-SX)	88=>92	1320/1625	<b>07.0090</b>	4643029045	0,542
Carina II (AT171) 1,6-D (drum brake) (RH-DX)	88=>92	1350/1660	<b>07.0091</b>	4642029035	0,639
Carina II 2,0 (ST171) (disc brake) (LH-SX)	88=>92	1310/1610	<b>07.0092</b>	4643029055	0,569
Carina II 2,0 (ST171) (disc brake) (RH-DX)	88=>92	1340/1645	<b>07.0093</b>	4642029045	0,570
Carina E all (LH-SX)	93=>	1500/1780	<b>07.0340</b>	4643020361	0,598
Carina E all (RH-DX)	93=>	1445/1725	<b>07.0341</b>	4642020351	0,673
Carina E 2,0-2,0 GT (RH-DX)	92=>97	1460/1710	<b>07.2027</b>	4642020360	•
Carina E 2,0-2,0 GT (LH-SX)	92=>97	1510/1760	<b>07.2028</b>	4643020450	•
Carina E all (front-avt)	93=>97	340	<b>07.1467</b>	4641020380	•
Celica (LH-SX)	70=>76	830/1465	<b>07.908</b>	4643014020	0,374

# ERRATA CORRIGE

## page. 136





COMANDI FLESSIBILI FUNE FRENO A MANO - BRAKE CABLES - CABLES DE FREIN  
BREMSSEILE - CABLES DE FRENO - CABOS DE TRAVAO  
LINKI HAMULCA - BRZDOVÁ LANKA - ТРОСЫ РУЧНОГО ТОРМОЗА

				OEM REF.	
<b>TOYOTA</b>					
Corolla Verso II all (RH-DX)	03/04=>	1770/1985	<b>07.2078</b>	464200F010	0,692
Corolla Verso II all (LH-SX)	03/04=>	1720/1930	<b>07.2079</b>	464300F010	0,674





# ERRATA CORRIGE

## page. 138

COMANDI FLESSIBILI FUNE FRENO A MANO - BRAKE CABLES - CABLES DE FREIN  
BREMSSEILE - CABLES DE FRENO - CABOS DE TRAVAO  
LINKI HAMULCA - BRZDOVÁ LANKA - ТРОСЫ РУЧНОГО ТОРМОЗА

				OEM REF.	
<b>TOYOTA</b>					
Rav 4 III 2,0 VVTi/2,2 D4d D-CAT (front-avt)	12/08=>	320	<b>07.2080</b>	4641042050	●

**COMANDI FLESSIBILI FUNE FRENO A MANO - BRAKE CABLES - CABLES DE FREIN  
BREMSSEILE - CABLES DE FRENO - CABOS DE TRAVAO  
LINKI HAMULCA - BRZDOVÁ LANKA - ТРОСЫ РУЧНОГО ТОРМОЗА**

				OEM REF.	
<b>TOYOTA</b>					
Celica (LH-SX)	76=>78	800/1400	<b>07.0084</b>	4643014021	0,391
Celica (RH-DX)	76=>78	780/1380	<b>07.0151</b>	4642014021	0,345
Celica (LH-SX)	78=>	890/1835	<b>07.0094</b>	4643014070	0,427
Celica (RH-DX)	78=>	815/1025	<b>07.0095</b>	4642014070	0,384
Celica SW (RH-DX)	78=>80	615/795	<b>07.0153</b>	4642015050	0,315
Celica SW (LH-SX)	78=>80	920/1340	<b>07.0096</b>	4643014200	0,382
Celica SW (LH-SX)	82=>	890/1415	<b>07.0083</b>	4643014210	0,429
Celica SW (RH-DX)	82=>	800/1400	<b>07.0084</b>	4642014170	0,391
Celica (LH/RH-SX/DX)	83=>85	1180/1570	<b>07.0086</b>	4643029015-4642039015	0,503
Celica (front-avt)	83=>85	300	<b>07.0068</b>	4641020210-4641002040 4641020230-4641020300 4641010030-4641012160 4641012210-94857010	0,034
Celica GTS (MA61-RA63) (front-avt)	83=>85	325	<b>07.0343</b>	4641024010	0,038
Celica GTS (MA61-RA63) (RH-DX)	83=>85	920/1290	<b>07.0345</b>	4642014200	0,466
Celica AT160 (LH-SX)	08/85=>	1200/1580	<b>07.0346</b>	4643029015	0,548
Celica AT160 (RH-DX)	08/85=>	1210/1585	<b>07.0347</b>	4642029015	0,567
Celica AT162 (LH-SX)	08/85=>	1200/1565	<b>07.0348</b>	4643029035	•
Celica AT162 (RH-DX)	08/85=>	1210/1565	<b>07.0349</b>	4642029025	0,541
Celica all (exc.4WD) (LH-SX)	09/93=>	1410/1665	<b>07.0353</b>	4643020520	•
Celica all (exc.4WD) (RH-DX)	09/93=>	1360/1625	<b>07.0354</b>	4642020440	0,625
Celica all (front-avt)	09/93=>	310	<b>07.0554</b>	4641012150-4641020420	0,036
Celica all (exc.4WD) (RH-DX)	98=>	1655	<b>07.1012</b>	4642020410	0,564
Celica all ZTZ23 (front-avt)	08/99=>	385	<b>07.1471</b>	4641020450	0,045
Celica all ZTZ23 (LH-SX)	08/99=>	1455/1665	<b>07.1549</b>	4643020580	0,575
Celica all ZTZ23 (RH-DX)	08/99=>	1480/1707	<b>07.1550</b>	4642020460	0,585
MR2 all (front-avt)	91=>99	400/610	<b>07.1638</b>	4641017040	•
MR2 all (LH-SX)	99=>	1438/1575	<b>07.1823</b>	4643017091	•
MR2 all (RH-DX)	99=>	1438/1575	<b>07.1824</b>	4642017091	•
Camry SV10 (LH-SX)	82=>	1150/1535	<b>07.0154</b>	4643039025	0,548
Camry SV10 (RH-DX)	82=>	1180/1570	<b>07.0086</b>	4643029015	0,503
Camry SV11-25ELC-2,0 (LH-SX)	84=>86	1150/1535	<b>07.0154</b>	4643039025	0,548
Camry SV11-25ELC-2,0 (RH-DX)	84=>86	1180/1570	<b>07.0086</b>	4643029015	0,503
Camry 1,8-2,0 (LH-SX)	87=>	1330/1670	<b>07.0355</b>	4643039045	0,587
Camry 1,8-2,0 (RH-DX)	87=>	1365/1705	<b>07.0356</b>	4642039045	0,587
Camry SV21-2VZ ABS (LH-SX)	88=>91	1320/1645	<b>07.0357</b>	4643039055	0,580
Camry SV21-2VZ ABS (RH-DX)	88=>91	1360/1680	<b>07.0358</b>	4642039055	0,576
Camry 2,0 3SFE Wagon (LH-SX)	86=>91	1310/1675	<b>07.0548</b>	4643039065	0,607
Camry 2,0 3SFE Wagon (RH-DX)	86=>91	1350/1715	<b>07.0549</b>	4642039065	0,605
Camry SXV10-VCV10 MT-SSFE-3VZFE (LH-SX)	86=>91	1420/1750	<b>07.0550</b>	4643033010	0,652
Camry SXV10-VCV10 MT-SSFE-3VZFE (RH-DX)	86=>91	1440/1770	<b>07.0551</b>	4642033010	0,649
Camry 3VZ-FE-5SFE ABS (LH-SX)	91=>94	1425/1720	<b>07.0359</b>	4643033041	0,612
Camry 3VZ-FE-5SFE ABS (RH-DX)	91=>94	1433/1735	<b>07.0344</b>	4642033041	•
Camry all (front-avt)	95=>98	355	<b>07.1630</b>	4641033070	0,037
Camry all (LH-SX)	95=>98	1450/1790	<b>07.1631</b>	4643033060	0,656
Camry all (RH-DX)	95=>98	1474/1814	<b>07.1014</b>	4642033060	0,369
Camry all ACV-MCV30 (RH-DX)	08/01=>	1423/1632	<b>07.1547</b>	4642033100	0,608
Camry all ACV-MCV30 (LH-SX)	08/01=>	1423/1623	<b>07.1629</b>	4643033100	•
Camry all ACV-MCV30 (front-avt)	08/01=>	1490/1735	<b>07.1628</b>	4641033120	0,769

**COMANDI FLESSIBILI FUNE FRENO A MANO - BRAKE CABLES - CABLES DE FREIN  
BREMSEILE - CABLES DE FRENO - CABOS DE TRAVAO  
LINKI HAMULCA - BRZDOVÁ LANKA - ТРОСЫ РУЧНОГО ТОРМОЗА**





				<b>OEM REF.</b>	
---	---	---	--	-----------------	---

<b>TOYOTA</b>					
Previa 2,4 TCR11 (front-avt)	11/90=>	330/1513	<b>07.0747</b>	4641028100-4641028240	0,239
Previa 2,4 TCR11 (RH-DX)	11/90=>	1008/1210	<b>07.0748</b>	4642028240	0,559
Previa 2,4 TCR11 (LH-SX)	11/90=>	751/956	<b>07.0749</b>	4643028200	0,393
Previa (RHD mod.) (front-avt)	00=>	878/1187	<b>07.1545</b>	4641028230	•
Rav 4 all (front-avt)	05/00=>	408	<b>07.1019</b>	4641042040	0,046
Rav 4 (3 doors) (LH-SX)	07/94=>	1060/1345	<b>07.1017</b>	4643042010	0,564
Rav 4 (3 doors) (RH-DX)	07/94=>	1060/1335	<b>07.1018</b>	4642042010	0,565
Rav 4 all (front-avt)	07/94=>00	260	<b>07.1459</b>	4641042010	0,033
Rav 4 all (3 doors) (LH-SX)	05/00=>	1040/1310	<b>07.1640</b>	4643042100	•
Rav 4 all (3 doors) (RH-DX)	05/00=>	1040/1310	<b>07.1641</b>	4642042100	0,035
Rav 4 all (5 doors) (LH-SX)	94/00=>	1255/1540	<b>07.1642</b>	4643042020	•
Rav 4 all (5 doors) (RH-DX)	94/00=>	1255/1540	<b>07.1643</b>	4642042020	•
Rav 4 (ACA21-ZCA2) (5 doors) (RH-DX)	05/00=>	1190/1425	<b>07.1644</b>	4642042090	•
Rav 4 (ACA21-ZCA2) (5 doors) (LH-SX)	05/00=>	1190/1425	<b>07.1645</b>	4643042090	•
Rav 4 (ACA21-ZCA2) (disc brake) (LH-SX)	05/00=>	1190/1425	<b>07.1646</b>	4643042070	•
Rav 4 (ACA21-ZCA2) (disc brake) (RH-DX)	05/00=>	1190/1425	<b>07.1647</b>	4642042070	•
Rav 4 II 1,8-2,0 VVTi 4x4 (LH-SX)	05/00=>10/05	1030/1275	<b>07.2025</b>	4643042080	•
Rav 4 II 1,8-2,0 VVTi 4x4 (RH-DX)	05/00=>10/05	1030/1275	<b>07.2026</b>	4642042080	•
Rav 4 III 2,0 VVTi/2,2 D4d D-CAT (front-avt)	12/08=>	320	<b>07.2050</b>	4641042050	•
Urban Cruiser all (disc brake) (LH-SX)	09=>	1430/1620	<b>07.2029</b>	4643052161	•
Urban Cruiser all (disc brake) (RH-DX)	09=>	1475/1665	<b>07.2030</b>	4642052161	•
Corona MKII-RX (RH-DX)	73=>	850/1330	<b>07.911</b>	4642022110	0,388
Corona RX 17-27-28-MX 27 SW (RH/LH-DX/SX)	76=>	870/1335	<b>07.0100</b>	4642023060	0,395
Avensis Sedan-SW (front-avt)	98=>	330	<b>07.0739</b>	4641005020	0,037
Avensis Sedan-SW (LH-SX)	98=>	1525/1830	<b>07.0740</b>	4643005020	0,689
Avensis Sedan-SW (RH-DX)	98=>	1480/1790	<b>07.0741</b>	4642005020	0,676
Avensis all (disc brake) (LH-SX)	00=>	1534/1805	<b>07.1010</b>	4643020600	0,677
Avensis all (disc brake) (RH-DX)	00=>	1493/1760	<b>07.1011</b>	4642020480	0,691
Avensis all (disc brake) (LH-SX)	00=>01	1617/1867	<b>07.1469</b>	4643020640	0,734
Avensis all (disc brake) (RH-DX)	00=>01	1574/1825	<b>07.1470</b>	4642020640	0,718
Avensis Verso (front-avt)	03/01=>	317	<b>07.1468</b>	4641044050	0,036
Avensis (disc brake) (LH-SX)	03/03=>07	1473/1770	<b>07.1847</b>	4643005020-4643020680	•
Avensis (disc brake) (RH-DX)	03/03=>07	1530/1823	<b>07.1848</b>	4642005030-4643020570	•



<b>TOYOTA - Commercial Vehicle</b>					
Picnic all 2,0i 16v-2,2 TD (RH-DX)	96=>05/01	895/1305	<b>07.1291</b>	4642044010	0,437
Picnic all 2,0i 16v-2,2 TD (LH-SX)	96=>05/01	975/1390	<b>07.1292</b>	4643044010	0,477
Picnic all 2,0 16v-2,2 Td (front-avt)	96=>05/01	427/793	<b>07.1825</b>	4641044010	0,239
Hi-Lux 20 (front-avt)	75=>	1775/2440	<b>07.0101</b>	4641026091	0,363
Hi-Lux 30 (front-avt)	75=>	1975/2730	<b>07.0102</b>	4641026110	0,401
Hi-Lux Pick-Up (front-avt)	79=>	625/1030	<b>07.1826</b>	4641035051-4641035100	•
Hi-Lux 30/40 WB- D SWB (front-avt)	79=>83	820/1210	<b>07.0103</b>	4641026111-4641035151	0,175

**COMANDI FLESSIBILI FUNE FRENO A MANO - BRAKE CABLES - CABLES DE FREIN  
BREMSSEILE - CABLES DE FRENO - CABOS DE TRAVAO  
LINKI HAMULCA - BRZDOVÁ LANKA - ТРОСЫ РУЧНОГО ТОРМОЗА**

				OEM REF.	
<b>TOYOTA - Commercial Vehicle</b>					
Hi-Lux YN-LN 55/56/57 (LH-SX)	83=>88	1110/1940	<b>07.0370</b>	4643035200	0,453
Hi-Lux YN-LN 55/56/57 (RH-DX)	83=>88	1200/1955	<b>07.1025</b>	4642035230-4642035200	•
Hi-Lux 2,2 4x4 YN 67 (front-avt)	86=>	1015/1720	<b>07.1023</b>	4641035270	•
Hi-Lux Pick-Up LN85/86 (front-avt)	09/88=>08/97	772/1178	<b>07.1994</b>	4641035500	•
Hi-Lux YN 51-LN 51 SWB (RH-DX)	90=>	955/1735	<b>07.0371</b>	4642005735	0,406
Hi-Lux YN 51-LN 51 SWB (LH-SX)	90=>	1050/1730	<b>07.0372</b>	4643005735	0,422
Hi-Lux LN166 (front-avt)		1710/2180	<b>07.1546</b>	4641035830	0,046
Hi-Lux LN145-RZN17 2wd (LH-SX)	97=>	1250/2028	<b>07.1827</b>	4643035490	0,676
Hi-Lux LN145-RZN17 2wd (RH-DX)	97=>	1275/2016	<b>07.1828</b>	4642035640	•
Hi-Ace 2,0-1,6-Pick-Up Van-RH22 (front-avt)	77=>82	1950/2710	<b>07.0373</b>	4641026080	0,391
Hi-Ace 1,8-2,0 YH50/51-YH60/61 D 2,2-2,4 LH50/51-LH60/61 (front-avt)	82=>85	2090/2863	<b>07.0750</b>	4641026190	0,455
Hi-Ace LH-YH 50/60 (front-avt)	08/85=>	2100/2840	<b>07.0104</b>	4641026230	0,364
Hi-Ace (LH-SX)	75=>	655/1600	<b>07.0157</b>	4643026040	0,408
Hi-Ace (RH-DX)	75=>	660/970	<b>07.0158</b>	4642026040	0,373
Hi-Ace LY-YH 50 (LH/RH-SX/DX)	82=>	505+810/ 1890	<b>07.0105</b>	4642026082-4642026080 4642026081	0,503
Hi-Ace LH-YH 60 LWB (LH/RH-SX/DX)	83=>	490+970/ 2070	<b>07.0106</b>	4642026090	0,565
Hi-Ace LH-B LWB (LH/RH-SX/DX)	10/89=>	470+1540/ 2535	<b>07.0108</b>	4642026320	0,798
Hi-Ace LH-A SWB (LH/RH-SX/DX)	10/89=>	470+1280/ 2280	<b>07.0107</b>	4642026310	0,718
Hi-Ace 2,2 Panel Van-Super 16-YH63 LWB (LH/RH-SX/DX)	88=>90	560+560/ 2665	<b>07.0376</b>	4642005620	0,579
Hi-Ace 2,2 Panel Van-Super 16-YH63 LWB (LH/RH-SX/DX)	91=>	500+560/ 2655	<b>07.0377</b>	4642005621	0,618
Hi-Ace Van all LHX-RCH 12/13 (front-avt)	11/96=>	835/1217	<b>07.1829</b>	4641026451	•
Hi-Ace all (front-avt)	04/98=>	835/1215	<b>07.1475</b>	4641026450	0,420
Hi-Ace Van all LH-RZH154/155 (LH-SX)	95=>99	1285/1586	<b>07.1634</b>	4643026430	•
Hi-Ace Van all LH-RZH154/155 (RH-DX)	95=>99	2148/2454	<b>07.1635</b>	4642026600	•
Hi-Ace all LXH-RCH12/13 (LH-SX)	95=>99	1236/1550	<b>07.1636</b>	4643026260	•
Hi-Ace II LXH12 2,4 TD Bus/Van (RH-DX)	11/99=>04	1010/1375	<b>07.1637</b>	4642026410-4642026420	•
Hi-Ace II LXH12 2,4 TD Bus/Van (LH-SX)	11/99=>04	1251/1565	<b>07.1916</b>	4643026271-4643026270	•
Hi-Ace all LXH18-RCH18 SWB (LH-SX)	11/99=>04	1251/1565	<b>07.1916</b>	4643026271-4643026270	•
Hi-Ace all LXH28-RCH18 SWB (LH-SX)	11/99=>04	1319/1985	<b>07.1917</b>	4643026361-4643026360	•
Hi-Ace all LXH28-RCH18 SWB (RH-DX)	11/99=>04	1454/1730	<b>07.1918</b>	4642026510	•
Hi-Ace IV LXH28-RCH28 SWB (LH-SX)	11/99=>04	1319/1985	<b>07.1917</b>	4643026361-4643026360	•
Hi-Ace IV LXH28-RCH28 SWB (RH-DX)	11/99=>04	1454/1730	<b>07.1918</b>	4642026510	•
Hi-Ace III KLH12 2,5 D4d 16v Bus/Van (RH-DX)	01=>	1010/1375	<b>07.1637</b>	4642026410-4642026420	•
Hi-Ace III KLH12 2,5 D4d 16v Bus/Van (LH-SX)	01=>	1251/1565	<b>07.1916</b>	4643026271-4643026270	•
Hi-Ace IV KLH12/18 2,5 D4d 16v Bus (RH-DX)	06=>	1010/1375	<b>07.1637</b>	4642026410-4642026420	•
Hi-Ace IV KLH12/18 2,5 D4d 16v Bus	06=>	1251/1565	<b>07.1916</b>	4643026271-4643026270	•

**VAUXHALL**

Astra Caravan	86=>91		<b>07.024</b>	90369711	•
Chevette	74=>	2445	<b>07.393</b>	8982053-522526	•
Cavalier Estate (LH-SX)	84=>	215/845	<b>07.527</b>	92019440	0,193
Cavalier Estate (RH-DX)	84=>	210+1150/ 2020	<b>07.528</b>	92019439	0,632
Viva/Firenza (front-avt)	70=>	1135/2025	<b>07.780</b>	2682327	•

**COMANDI FLESSIBILI FUNE FRENO A MANO - BRAKE CABLES - CABLES DE FREIN  
BREMSSEILE - CABLES DE FRENO - CABOS DE TRAVAO  
LINKI HAMULCA - BRZDOVÁ LANKA - ТРОСЫ РУЧНОГО ТОРМОЗА**

				<b>OEM REF.</b>	
---	---	---	--	-----------------	---

**VAUXHALL**

Viva/Firenza	70=>	1415	<b>07.781</b>	7202006	●
--------------	------	------	---------------	---------	---







**VAUXHALL - Commercial Vehicle**

Rascal 1/80	86=>	800+840/ 1965	<b>07.031</b>	91112648	0,682
Rascal 1/70	86=>	574+809/ 1812	<b>07.542</b>	91122085	●
Midi all (front-avt)	85=>	2165/2624	<b>07.1536</b>	91133434	0,700
Midi (RH-DX)	85=>	313	<b>07.028</b>	94233607	0,088
Midi (LH-SX)	85=>	908	<b>07.029</b>	94233606	0,122
Midi	85=>	2200/2655	<b>07.030</b>	94226685	0,781
Midi all (mod. 80) (LH/RH-SX/DX)	85=>	549/900	<b>07.543</b>	91123067-91139077	●
CF SWB (LH/RH-SX/DX)	71=>	900/1155	<b>07.992</b>	8829951-91106936	0,315
CF LWB (LH/RH-SX/DX)	71=>	900/1835	<b>07.064</b>	91106935-8829950	0,336
CF2 (LH/RH-SX/DX)	83=>	864/1821	<b>07.228</b>	522564-91106933	0,327
CF2 (LH/RH-SX/DX)	83=>	867/1125	<b>07.0557</b>	91106934	●
Brava Pick-up Tfr all 2WD (interm.)	88=>06/99	1778	<b>07.1380</b>	522619-94367286	●
Brava Pick-up Tfr all 4WD (interm.)	88=>06/99	1325/1380	<b>07.1381</b>	4303489-94367287	●
Brava Pick-up Tfr all 2WD (RH-DX)	07/99=>	1700/1872	<b>07.1382</b>	522520-97174665	●
Brava Pick-up Tfr all 2WD (LH-SX)	07/99=>	1640/1812	<b>07.1383</b>	522523-97217149	●
Brava Pick-up Tfr all 4WD (RH-DX)	07/99=>	1700/1858	<b>07.1384</b>	522428-97111565	0,784
Brava Pick-up Tfr all 4WD (LH-SX)	07/99=>	1630/1798	<b>07.1385</b>	522429-97111566	●
Brava (RH-DX)	97=>06/99	1438/1684	<b>07.0232</b>	94366769	0,611
Brava (LH-SX)	97=>06/99	1358/1606	<b>07.0233</b>	94366770	0,572
Arena all (front-avt)	98=>08/01	522/747	<b>07.0968</b>	9108241	0,220
Arena all (LH-SX)	01=>	925/1330	<b>07.0969</b>	9108242	0,385
Arena all (RH-DX)	01=>	1020/1424	<b>07.0970</b>	9108245	0,471
Arena all (LH-SX)	01=>	935/1295	<b>07.0289</b>	9108243	0,416
Arena all (RH-DX)	01=>	1020/1390	<b>07.0290</b>	9108247	0,469





**VOLKSWAGEN**

Lupo all (drum brake) (LH/RH-SX/DX)	98=>	800/1395	<b>07.0754</b>	6X0609721F	0,307
Lupo all (disc brake) (LH/RH-SX/DX)	98=>	975/1505	<b>07.0755</b>	6X0609721D-6X0609721E	0,339
Up all	=>11	835/1530	<b>07.2034</b>	1S0609721A	●
Up all (LH/RH-SX/DX)	12=>	825/1520	<b>07.2024</b>	1S0609721C	●
Polo (front-avt)	74=>84	800	<b>07.288</b>	861609729	0,050
Polo (front-avt)	85=>	1100/1610	<b>07.458</b>	867609721	0,413
Polo	=>08/78	370+630/ 1960	<b>07.533</b>	861609721	0,395
Polo	09/78=>	385+635/ 1990	<b>07.588</b>	861609721A-861609721B	0,401
Polo	85=>	395/660	<b>07.244</b>	867609701	0,163

**COMANDI FLESSIBILI FUNE FRENO A MANO - BRAKE CABLES - CABLES DE FREIN  
BREMSSEILE - CABLES DE FRENO - CABOS DE TRAVAO  
LINKI HAMULCA - BRZDOVÁ LANKA - ТРОСЫ РУЧНОГО ТОРМОЗА**

				OEM REF.	
<b>VOLKSWAGEN</b>					
Polo all (drum brake-disc brake) (LH/RH-SX/DX)	09/94=>	965/1510	<b>07.0388</b>	6N0609721B-6N0609721E 6N0609721G	0,343
Polo all (ch. 6NWW130000-6WY220000- ch. 6NWW130001-6WY220001) (LH/RH-SX/DX)	09/96=>	955/1515	<b>07.0756</b>	6N0609721F-6N0609721J	0,358
Polo all (drum brake) (LH/RH-SX/DX)	09/97=>	955/1515	<b>07.0757</b>	6N0609721K	0,354
Polo ABS (ch. 6NWW130001-6WY220001) (LH/RH-SX/DX)	09/97=>	955/1515	<b>07.0757</b>	6N0609721K	0,354
Polo all (disc brake) (LH/RH-SX/DX)	99=>	1132/1641	<b>07.0989</b>	6N0609721M-6N0609721L 6N0609721H	0,415
Polo all (drum brake) (LH/RH-SX/DX)	01=>	918/1580	<b>07.0992</b>	6Q0609721B-6Q0609721H 6Q0609721M-6Q0609721N	0,340
Polo all (disc brake) (LH/RH-SX/DX)	01=>	1045/1645	<b>07.0993</b>	6Q0609721C-6Q0609721F 6Q0609721G-6Q0609721L	0,356
Polo all (disc brake) (LH/RH-SX/DX)	06/06=>	1045/1640	<b>07.1658</b>	6Q0609721K	0,404
Polo 2010 all (disc brake) (LH/RH-SX/DX)	09=>	1045/1640	<b>07.1812</b>	6R0609721C	•
Polo 2010 all (drum brake) (LH/RH-SX/DX)	09=>	935/1590	<b>07.1813</b>	6R0609721B	•
Derby (front-avt)	74=>84	800	<b>07.288</b>	861609729	0,050
Derby (front-avt)	85=>	1100/1610	<b>07.458</b>	867609721	0,413
Derby	=>08/78	370+630/ 1960	<b>07.533</b>	861609721	0,395
Derby	09/78=>	385+635/ 1990	<b>07.588</b>	861609721A-861609721B	0,401
Derby	85=>	395/660	<b>07.244</b>	867609701	0,163
Derby 2010 all (disc brake) (LH/RH-SX/DX)	09=>	1045/1640	<b>07.1812</b>	6R0609721C	•
Derby 2010 all (drum brake) (LH/RH-SX/DX)	09=>	935/1590	<b>07.1813</b>	6R0609721B	•
1200 Beetle (LH/RH-SX/DX)	=>64	535/1755	<b>07.450</b>	113609721F	0,292
1302 (LH/RH-SX/DX)	70=>72	550/1830	<b>07.608</b>	113609721J	0,294
1200 Beetle (LH/RH-SX/DX)	65=>07/66	550/1800	<b>07.454</b>	113609721K	0,282
1200 Beetle (LH/RH-SX/DX)	=>07/67	550/1790	<b>07.452</b>	113609721L	0,301
1200-1300 Beetle (LH/RH-SX/DX)	08/67=>	520/1780	<b>07.453</b>	113609721M	0,288
1303 (LH/RH-SX/DX)	=>08/72	550/1755	<b>07.606</b>	133609721	0,302
1303 (LH/RH-SX/DX)	09/72=>	555/1765	<b>07.607</b>	133609721A	0,291
1500-1600 (type 3) (LH/RH-SX/DX)	08/68=>	660/1790	<b>07.456</b>	311609721C	0,322
New Beetle (-ch. 9CY607008-1CY414262) (LH/RH-SX/DX)	98=>	820/1055	<b>07.0410</b>	1J0609721E	0,392
New Beetle (-ch. 9CY607009-1CY414263) (LH/RH-SX/DX)	99=>	1070/1700	<b>07.0991</b>	1J0609721K-1J0609721AC 1J0609721AD-1J0609721T	0,372
Scirocco	84=>92	1100/1730	<b>07.1555</b>	533609721	•
Scirocco (LH/RH-SX/DX)	=>07/75	515/1740	<b>07.464</b>	171609721	0,251
Scirocco (LH/RH-SX/DX)	08/75=>	1050/1705	<b>07.642</b>	171609721B-171609721C 175609721	0,379
Scirocco (LH/RH-SX/DX)	08=>	805/1443	<b>07.1442</b>	1K0609721BB	0,388
Jetta (LH/RH-SX/DX)	08/75=>	1050/1705	<b>07.642</b>	171609721B-171609721C 175609721	0,379
Jetta all (drum brake) (LH/RH-SX/DX)	09/83=>	1120/1760	<b>07.864</b>	191609721	0,444
Jetta GLI (disc brake) (LH/RH-SX/DX)	09/83=>	1180/1800	<b>07.984</b>	191609721A	0,463
Jetta GLI (disc brake) (LH/RH-SX/DX)	87=>	1255/1850	<b>07.040</b>	191609721D	0,492
Jetta GLI (disc brake) (LH/RH-SX/DX)	90=>91	1230/1625	<b>07.289</b>	191609721F	0,509
Jetta (162) all (LH/RH-SX/DX)	10/10=>	827/1598	<b>07.1996</b>	5C0609721D	0,351

**COMANDI FLESSIBILI FUNE FRENO A MANO - BRAKE CABLES - CABLES DE FREIN  
BREMSSEILE - CABLES DE FRENO - CABOS DE TRAVAO  
LINKI HAMULCA - BRZDOVÁ LANKA - ТРОСЫ РУЧНОГО ТОРМОЗА**

				OEM REF.	
<b>VOLKSWAGEN</b>					
Vento (drum brake) (LH/RH-SX/DX)	09/91=>	935/1500	<b>07.563</b>	1H0609721-1HM609721	0,388
Vento (disc brake) (LH/RH-SX/DX)	09/91=>	1100/1605	<b>07.565</b>	1H0609721A-535609721A 1HM609721A	0,458
Vento (disc brake) (LH/RH-SX/DX)	95=>97	1610	<b>07.0762</b>	1H0609721E	0,374
Bora all (ch. 1JY238581-)	09/99=>	1070/1700	<b>07.0991</b>	1J0609721AC-1J0609721AD 1J0609721K-1J0609721T	0,372
Bora Syncro (LH/SX-RH/DX)	98=>	1090/1273	<b>07.0806</b>	1J0.609.721R-1J0.609-721L	0,459
Golf (LH/RH-SX/DX)	=>07/75	515/1740	<b>07.464</b>	171609721	0,251
Golf (LH/RH-SX/DX)	08/75=>	1050/1705	<b>07.642</b>	171609721B-171609721C 175609721	0,379
Golf (drum brake) (LH/RH-SX/DX)	09/83=>	1120/1760	<b>07.864</b>	191609721	0,444
Golf GTI (disc brake) (LH/RH-SX/DX)	09/83=>	1180/1800	<b>07.984</b>	191609721A	0,463
Golf GTI (disc brake) (LH/RH-SX/DX)	87=>	1255/1850	<b>07.040</b>	191609721D	0,492
Golf all (drum brake) (LH/RH-SX/DX)	88=>91	1100/1525	<b>07.287</b>	191609721E	0,429
Golf all (drum brake) (LH/RH-SX/DX)	88=>91	1100/1525	<b>07.287</b>	191609721E	0,429
Golf II Syncro (drum brake) (LH/RH-SX/DX)	85=>91	1080/1570	<b>07.0759</b>	191609721C	0,409
Golf II Syncro (disc brake) (LH/RH-SX/DX)	85=>91	1195/1655	<b>07.0761</b>	191609721H-191609721K	0,452
Golf GTI (disc brake) (LH/RH-SX/DX)	90=>91	1230/1625	<b>07.289</b>	191609721F	0,509
Golf (drum brake) (LH/RH-SX/DX)	09/91=>	935/1500	<b>07.563</b>	1H0609721-1HM609721	0,388
Golf (disc brake) (LH/RH-SX/DX)	09/91=>	1100/1605	<b>07.565</b>	1H0609721A-535609721A 1HM609721A	0,458
Golf III Syncro (disc brake) (LH/RH-SX/DX)	93=>	995/1600	<b>07.1295</b>	1H0609721C	0,402
Golf III Syncro (drum brake) (LH/RH-SX/DX)	93=>	935/1582	<b>07.1296</b>	1H0609721B	0,399
Golf III Variant (drum brake) (LH/RH-SX/DX)	95=>97	940/1500	<b>07.0760</b>	1H0609721D	0,341
Golf III (disc brake) (LH/RH-SX/DX)	95=>97	1610	<b>07.0762</b>	1H0609721E	0,374
Golf III GTI 16v (LH/RH-SX/DX) - USA mod.	09/91=>	1180/1580	<b>07.488</b>	1GM609721	0,445
Golf IV all (-ch.1JY238580) (LH/RH-SX/DX)	98=>	820/1055	<b>07.0410</b>	1J0609721E	0,392
Golf IV all (LH/RH-SX/DX)	98=>	1052/1690	<b>07.1028</b>	1J0609721H	0,457
Golf IV all (ch. 1JY238581-)	09/99=>	1070/1700	<b>07.0991</b>	1J0609721AC-1J0609721AD 1J0609721K-1J0609721T	0,372
Golf IV (LH/SX-RH/DX)	98=>	1090/1273	<b>07.0806</b>	1J0.609.721R-1J0.609-721L	0,459
Golf V all (LH/SX-RH/DX)	10/03=>	810/1450	<b>07.1441</b>	1K0609721Q	0,366
Golf V-Golf V 4 motion-Golf V Plus (LH/SX-RH/DX)	10/03=>	805/1443	<b>07.1442</b>	1K0609721AA-1K0609721S 1K0609721T	0,388
Golf VI (LH/SX-RH/DX)	10/03=>	805/1443	<b>07.1442</b>	1K0609721BB	0,388
Dasher all	=>07/76	490+500/ 2230	<b>07.465</b>	321609721	0,760
Dasher all	08/76=>81	460+460/ 2255	<b>07.489</b>	321609721A	0,428
Passat all	=>07/76	490+500/ 2230	<b>07.465</b>	321609721	0,760
Passat all	08/76=>81	460+460/ 2255	<b>07.489</b>	321609721A	0,428
Passat (4 cyl) all	81=>	1070+1070/ 2590	<b>07.245</b>	321609721C	0,782
Passat (5 cyl) (LH/RH-SX/DX)	81=>	1185/1340	<b>07.294</b>	321609721E	0,440
Passat 1,6-1,8-TD all (drum brake) (LH/RH-SX/DX)	88=>	1050/1640	<b>07.041</b>	357609721	0,418
Passat 1,8-2,0 (disc brake) (LH/RH-SX/DX)	88=>93	1180/1750	<b>07.0389</b>	357609721A-357609721D 357609721E	0,468
Passat Syncro (LH/RH-SX/DX)	89=>		<b>07.0764</b>	357609721C	0,438
Passat 1,8-2,0 (disc brake) (LH/RH-SX/DX)	93=>	1040/1725	<b>07.0390</b>	3A0609721A-3A0609721C	0,433
Passat 1,8-1,9 Tdi (drum brake) (LH/RH-SX/DX)	93=>	900/1625	<b>07.0399</b>	3A0609721-3A0609721B	0,407

**COMANDI FLESSIBILI FUNE FRENO A MANO - BRAKE CABLES - CABLES DE FREIN  
BREMSSEILE - CABLES DE FRENO - CABOS DE TRAVAO  
LINKI HAMULCA - BRZDOVÁ LANKA - ТРОСЫ РУЧНОГО ТОРМОЗА**

				<b>OEM REF.</b>	
---	---	---	--	-----------------	---

<b>VOLKSWAGEN</b>					
Passat all (LH-SX)	96=>	1577/1890	<b>07.1029</b>	3B0609721F-3B0609721L	1,044
Passat all (RH-DX)	96=>	1577/1890	<b>07.1030</b>	3B0609722F-3B0609722K	1,050
Passat T 4 motion	96=>	1660/1835	<b>07.1476</b>	3B0609721K-3B0609721AA	0,663
Santana (4 cyl) all	81=>	1070+1070/ 2590	<b>07.245</b>	321609721C	0,782
Santana (5 cyl) (LH/RH-SX/DX)	81=>	1185/1340	<b>07.294</b>	321609721E	0,440
Sharan all (interm.)	97=>	655	<b>07.0637</b>	1013482-7M0711472A	0,053
Sharan all (LH/RH-SX/DX)	97=>	1135/1295	<b>07.0638</b>	7M0609701B-95VW2A603AC	0,524
Sharan 7V8-7V9-1,8T 20v-1,9Tdi-1,9Tdi 4 motion 2,8V6 24v-2,8V6 24v 4 motion (LH/RH-SX/DX)	97=>01	1155/1320	<b>07.1783</b>	1109023-7M3609701 7M3609701D	•
Touran 1,6-2,0-1,9 Tdi-2,0 Tdi mod. T9G-TG58-T72 mod. Pr T53-T71 (LH/RH-SX/DX)	03=>	900/1555	<b>07.1298</b>	1T0609721F-1T0609721G	0,428
Touran all (mod. PR-TG0) (LH/RH-SX/DX)	03=>	900/1555	<b>07.1300</b>	1T0609721H-1T0609721J	0,350
Touran 2,0 Tdi-2,0 Fsi (LH/RH-SX/DX)	07=>	900/1555	<b>07.1300</b>	1T0609721K-1T0609721L	0,350
Touran 2,0 Ecofuel (LH/RH-SX/DX)	07=>	940/1610	<b>07.1833</b>	1T0609721M	•
Touareg all (LH/RH-SX/DX)	11/02=>	1640/1750	<b>07.1754</b>	7L0609721A	0,620
Touareg all (RHD mod.) (front-avt)	11/02=>	1420/1625	<b>07.1832</b>	7L0721556A-7L0721556C	0,620
Touareg MPV/VAN (front-avt)	06=>	1685/1890	<b>07.1760</b>	7L0721556B	•



<b>VOLKSWAGEN - Commercial Vehicle</b>					
Caddy (LH/RH-SX/DX)	75=>83	1050/1705	<b>07.642</b>	171609721B-171609721C 175609721	0,379
Caddy	09/83=>	1370/2035	<b>07.246</b>	179609721	0,503
Caddy (LH/RH-SX/DX)	96=>	1670	<b>07.0767</b>	6K9609721	0,525
Caddy p/up (LH/RH-SX/DX)	96=>00	1470/1780	<b>07.2033</b>	6U7609721	•
Caddy II all	06=>	549/1713	<b>07.1648</b>	2K9609721E	0,267
Caddy all	08=>	755/2025	<b>07.1850</b>	2K3609721B-1K3609721C	•
Caddy (III) all 4Motion (LH/RH-SX/DX)	08=>	561/1727	<b>07.1997</b>	2K0609721N-2K0609721R	0,307
Caddy (III) all Maxi 4Motion (LH/RH-SX/DX)	08=>	772/2037	<b>07.1998</b>	2K3609721G	0,380
Caddy (III) all SWB (LH/RH-SX/DX)	10=>	541/1705	<b>07.1999</b>	2K0609721P	0,235
Transporter 1,2-1,5 (LH/RH-SX/DX)	=>07/71	380/3435	<b>07.523</b>	211609701L	0,321
Transporter 1,6 (LH/RH-SX/DX)	71=>07/72	380/3435	<b>07.522</b>	211609701P	0,328
Transporter 1,7 (LH/RH-SX/DX)	08/72=>	380/2955	<b>07.463</b>	211609701T	0,322
Transporter (LH/RH-SX/DX)	71=>	530/3160	<b>07.986</b>	211609701J	0,360
Transporter (LH/RH-SX/DX)	72=>	540/3445	<b>07.459</b>	211609701Q	0,285
Transporter Syncro (LH-SX)	79=>90	960/1415	<b>07.1301</b>	251609701D	0,420
Transporter Syncro (RH-DX)	79=>90	920/1375	<b>07.1302</b>	251609702	0,568
Transporter 1,6-2,0 (LH/RH-SX/DX)	80=>90	1030/1480	<b>07.941</b>	251609701A-251609701B 251609701C	0,457
Transporter Syncro T2 (LH-SX)	85=>90	980/1400	<b>07.1303</b>	251609701F	•
Transporter Syncro T2 (RH-DX)	85=>90	1000/1415	<b>07.1304</b>	251609721E	•
Transporter all (drum brake) (LH/RH-SX/DX)	91=>96 =>95	520/845	<b>07.567</b>	701609701	0,235
Transporter T4 Syncro (LH/RH-SX/DX)	97=>	720/935	<b>07.0768</b>	7D0609701	0,331





**COMANDI FLESSIBILI FUNE FRENO A MANO - BRAKE CABLES - CABLES DE FREIN  
BREMSEILE - CABLES DE FRENO - CABOS DE TRAVAO  
LINKI HAMULCA - BRZDOVÁ LANKA - ТРОСЫ РУЧНОГО ТОРМОЗА**

				<b>OEM REF.</b>	
---	---	---	--	-----------------	---





<b>VOLKSWAGEN - Commercial Vehicle</b>					
Transporter T4 (ch. 70W120001-) (LH/RH-SX/DX)	97=>	720/938	<b>07.0769</b>	7D0609701A-7D0609701B	0,347
Transporter T5-Caravelle 2,5 Tdi (LH/RH-SX/DX)	03=>	1000/1270	<b>07.1649</b>	7H8609701G	0,390
Transporter T5 all (exc. 4x4) (LH/RH-SX/DX)	03=>	1005/1297	<b>07.1479</b>	7H0609721D	0,412
Transporter T5 all cab. 4x4 (LH/RH-SX/DX)	07/04=>	1648/2015	<b>07.1650</b>	7J3609701	•
Transporter T5 all LWB 4x4 (LH/RH-SX/DX)	07/04=>	1648/2015	<b>07.1651</b>	7H3609701H	0,629
Transporter T5 all SWB 4x4 (LH/RH-SX/DX)	07/04=>	1285/1650	<b>07.1652</b>	7H1609701F	•
Transporter T5 all SWB 4x4 (LH/RH-SX/DX)	07/09=>	1273/1631	<b>07.2000</b>	7E0609701C	0,517
Crafter all ch. 3250 (front-avt)	06=>	365/1468	<b>07.1723</b>	2E3609701A-9064202485	0,186
Crafter all ch. 3250 cab.rib. (front-avt)	06=>	271/1374	<b>07.1724</b>	2E3609701R-9064202885	•
Crafter all ch. 3665 (front-avt)	06=>	365/1867	<b>07.1725</b>	2E3609701L	•
Crafter all ch. 3665 cab.rib. (front-avt)	06=>	1271/1771	<b>07.1726</b>	2E3609701P-9064202685	•
Crafter all ch. 4325 (front-avt)	06=>	365/2522	<b>07.1727</b>	2E0609701M	•
Crafter all ch. 4325 cab.rib. (front-avt)	06=>	271/2425	<b>07.1728</b>	2E3609701Q-9064202785	•
Crafter 50 pt. 5t (LH/RH-SX/DX)	06=>	1065/1395	<b>07.1729</b>	2E0609701T-9064203085	•
Crafter all (LH/RH-SX/DX)	06=>	1065/1395	<b>07.1729</b>	2E0609701T	•
Crafter 50 pt. 5t (double wheels) (LH/RH-SX/DX)	06=>	1112/1432	<b>07.1730</b>	2E0609701AA-9064203185	•
Crafter all pt. 3t-3,2t-3,5t-4,6t (LH/RH-SX/DX)	06=>	1407/1666	<b>07.1731</b>	2E3609701J-9064202085	•
Crafter all pt. 5t (double wheels) (LH/RH-SX/DX)	06=>	1102/1430	<b>07.1906</b>	2E0609702C-9064204585	•
LT 31 (single wheels) (LH-SX)	75=>	730/1050	<b>07.989</b>	281609701B	0,298
LT 31 (single wheels) (RH-DX)	89=>	1310/1710	<b>07.990</b>	281609702B-281609702D 281609702C	0,489
LT 35-40-45 (twin wheels) (LH-SX)	75=>	695/980	<b>07.754</b>	291609701A	0,294
LT 35-40-45 (twin wheels) (RH-DX)	75=>	1130/1490	<b>07.755</b>	291609702A	0,411
LT 35-50 (twin wheels-short ch.) (LH-SX)	75=>	685/1010	<b>07.991</b>	291609701B-291609701D	0,291
LT 35-50 (twin wheels-short ch.) (RH-DX)	75=>	1150/1550	<b>07.044</b>	291609702B-291609702D	0,447
LT 45-55 (LH/RH-SX/DX)	83=>	1155/1410	<b>07.045</b>	291609701C	0,416
LT 28-55 2,4 D/Td (RH-DX)	85=>96	680/950	<b>07.0770</b>	291609701F	0,270
LT 28-55 2,4 D/Td (LH-SX)	85=>96	1140/1485	<b>07.0771</b>	291609702G	0,427
LT 40-45-50-55 (ch. 3650) (LH/RH-SX/DX)	12/82=>	1395	<b>07.0772</b>	293609701E	0,420
LT 28-30 (ch. 3000) (front-avt)	97=>	285/1435	<b>07.1131</b>	2D0609701-9014202085	•
LT 35 (ch. 3550) (double wheels) (front-avt)	97=>	285/1970	<b>07.1133</b>	2D0609701C	0,247
LT 28-30 (ch. 3550) (single wheel) (front-avt)	97=>	285/1990	<b>07.1306</b>	2D0609701A-9014202185	0,250
LT 35 (front-avt)	97=>	285/2460	<b>07.1134</b>	2D0609701B-9014202285	0,270
LT 46 (front-avt)	97=>	285/2440	<b>07.1309</b>	2D0609701D-9044200485	0,268
LT 28 (LH/RH-SX/DX)	97=>	1330/1515	<b>07.1135</b>	2D0609721-9014201885	0,687
LT 46 (RH-DX)	97=>	1350/1525	<b>07.1137</b>	2D0609721A-9044200185	0,746
LT 46 (LH-SX)	97=>	1350/1525	<b>07.1138</b>	2D0609722-9044200285	0,789

<b>VOLVO</b>					
140 all	71=>74	780+780/ 2470	<b>07.508</b>	684586	0,861
164 all	71=>74	780+780/ 2470	<b>07.508</b>	684586	0,861
240-260 all (LH/RH-SX/DX)	75=>	1565/1935	<b>07.529</b>	12057436	0,809
245-265 all (LH/RH-SX/DX)	75=>	2270/2635	<b>07.981</b>	12296869	1,074
340 B14 all (front-avt)	76=>82	736	<b>07.0391</b>	3266492	•

**COMANDI FLESSIBILI FUNE FRENO A MANO - BRAKE CABLES - CABLES DE FREIN  
BREMSSEILE - CABLES DE FRENO - CABOS DE TRAVAO  
LINKI HAMULCA - BRZDOVÁ LANKA - ТРОСЫ РУЧНОГО ТОРМОЗА**

				OEM REF.	
<b>VOLVO</b>					
340 B14 all (front-avt)	83=>	740	<b>07.053</b>	3286094	0,068
340-360 B19 all (front-avt)	83=>	235	<b>07.290</b>	32860504	0,035
340 B14 all (LH/RH-SX/DX)	76=>	800/1035	<b>07.980</b>	32715773	0,430
340-360 all (LH-SX)	81=>	1080/1285	<b>07.247</b>	32938060	0,522
340-360 all (RH-DX)	81=>	1170/1380	<b>07.251</b>	32938078	0,467
340-360 D16 (front-avt)	84=>	220	<b>07.0558</b>	3213055	0,055
340-360 D16 (LH-SX)	84=>	1240/1425	<b>07.0559</b>	3560082	0,477
340-360 D16 (RH-DX)	84=>	1370/1555	<b>07.0560</b>	3560083	0,511
PV544-Amazon	59=>70	800/1310	<b>07.0318</b>	682921	0,322
440 GL-GLT-Turbo (front-avt)	88=>	225	<b>07.047</b>	34106484-3343698	0,053
440 GLT-Turbo (disc brake)	87=>	1245/1455	<b>07.051</b>	3414613-3456981-3456984	0,511
440 GL	88=>	1150/1400	<b>07.050</b>	34301853	0,469
440-460 (drum brake)	91=>	1085/1340	<b>07.1031</b>	3457227	0,429
480 (front-avt)	88=>	225	<b>07.047</b>	34106484-3343698	0,053
480 (disc brake)	87=>	1245/1455	<b>07.051</b>	3414613-3456981-3456984	0,511
S40 all (LH-SX)	96=>00	1470/1585	<b>07.0773</b>	30850022	0,572
S40 all (RH-DX)	96=>00	1470/1585	<b>07.0774</b>	30850023	0,575
S40 all (front-avt)	96=>04	245	<b>07.1480</b>	3345598	0,029
S40 (LH-SX)	00=>	1470/1615	<b>07.1313</b>	30884537-30621298	0,554
S40 (RH-DX)	00=>	1470/1615	<b>07.1314</b>	30884538-30621299	0,547
S40 all	04=>	1700/1830+ 1745/1875	<b>07.1481</b>	30714215-4N514A603BA	0,468
S40 all (LH/RH-SX/DX)	08/05=>	1745/1860+ 1702/1816	<b>07.1755</b>	30742642-31257680	0,668
C30 all (LH/RH-SX/DX)	08/05=>	1745/1860+ 1702/1816	<b>07.1755</b>	30742642-31257680	0,668
C70 Coupé-Spyder	98=>04	1515/1695	<b>07.1484</b>	8600755-9475286	•
C70 II all (LH/RH-SX/DX)	08/05=>	1745/1860+ 1702/1816	<b>07.1755</b>	30742642-31257680	0,668
V40 all (LH-SX)	96=>00	1470/1585	<b>07.0773</b>	30850022	0,572
V40 all (RH-DX)	96=>00	1470/1585	<b>07.0774</b>	30850023	0,575
V40 all (front-avt)	96=>04	245	<b>07.1480</b>	3345598	0,029
V50 all (front-avt)	04=>	245	<b>07.1480</b>	3345598	0,029
V50 all	04=>	1700/1830+ 1745/1875	<b>07.1481</b>	30714215-4N514A603BA	0,468
V50 all (LH/RH-SX/DX)	08/05=>	1745/1860+ 1702/1816	<b>07.1755</b>	30742642-31257680	0,668
V70 all (exc. AWD) (LH/RH-SX/DX)	98=>	1450/1680	<b>07.0393</b>	35464905-9209756	0,595
V70 AWD	98=>00	1890/2170	<b>07.1318</b>	9157684-9209757	0,834
V70 all (exc. AWD) (LH/RH-SX/DX)	01=>	1890/1960	<b>07.1319</b>	3524199	0,752
V70 Bi-fuel	00=>04	1960/2035	<b>07.1559</b>	8666265	•
V70-V70 AWD (exc. Bi-fuel)	01=>04	1912/1993	<b>07.1483</b>	9434192-9485316	0,762
V70 all (front-avt)	01=>04	320	<b>07.1556</b>	9191484	•
V70 all AWD	03=>	1934/2024	<b>07.1851</b>	3524200	•
S60 all (exc. AWD) (LH/RH-SX/DX)	11/00=>	1847/1923	<b>07.1317</b>	30665093-9173146	0,746

**COMANDI FLESSIBILI FUNE FRENO A MANO - BRAKE CABLES - CABLES DE FREIN  
BREMSSEILE - CABLES DE FRENO - CABOS DE TRAVAO  
LINKI HAMULCA - BRZDOVÁ LANKA - ТРОСЫ РУЧНОГО ТОРМОЗА**

				OEM REF.	
<b>VOLVO</b>					
S60 AWD	01=>04	1875/1955	<b>07.1482</b>	8646151	0,713
S60 all (front-avt)	01=>04	320	<b>07.1556</b>	9191484	•
S60 Bi-fuel	01=>04	1935/2005	<b>07.1557</b>	8666266	•
S80 (exc. Bi-fuel)	99=>04	1912/1993	<b>07.1483</b>	9434192-9485316	0,762
S80 Bi-fuel	99=>04	1990/2060	<b>07.1558</b>	8666264-9492645	0,789
S80 all (front-avt)	01=>04	320	<b>07.1556</b>	9191484	•
S80 all AWD	03=>	1934/2024	<b>07.1851</b>	3524200	•
XC70 all	01=>04	1912/1993	<b>07.1483</b>	9434192-9485316	0,762
XC70 all (front-avt)	01=>04	320	<b>07.1556</b>	9191484	•
XC70 all (LH-SX)	03=>	2087/2160	<b>07.1852</b>	30681684	•
XC70 all (front-avt)	03=>	1878/1985	<b>07.2036</b>	30714012-30793827	0,736
XC90 all (LH/RH-SX/DX)	03=>	2114/2180	<b>07.1655</b>	30636224-30681683	•
XC90 all (LH-SX)	03=>	2087/2160	<b>07.1852</b>	30681684	•
XC90 all (front-avt)	03=>	1878/1985	<b>07.2036</b>	30714012-30793827	0,736
740-760 all (LH-SX)	82=>	1610/2205	<b>07.255</b>	12297834-13298336	0,808
740-760 all (RH-DX)	82=>	845	<b>07.252</b>	12297859	0,043
740-940 (Multilink) (front-avt)	84=>	1790/2080	<b>07.572</b>	13879370-68190313	0,834
740-940 (Multilink) (LH-SX)	84=>	365/530	<b>07.590</b>	13872569-68190321	0,169
740-940 (Multilink) (RH-DX)	84=>	370/755	<b>07.604</b>	13872577-68190339	0,184
740-760 all (LH-SX)	87=>	1615/2210	<b>07.291</b>	13877873-3530621-68193820	0,814
740-760 all (RH-DX)	87=>	910	<b>07.292</b>	13877881-3530622	0,070
S70 all (exc. AWD) (LH/RH-SX/DX)	98=>	1450/1680	<b>07.0393</b>	35464905-9209756	0,595
S70 AWD	98=>00	1890/2170	<b>07.1318</b>	9157684-9209757	0,834
S70 all (exc. AWD) (LH/RH-SX/DX)	01=>	1890/1960	<b>07.1319</b>	3524199	0,752
850 all (-ch. 47065) (LH/RH-SX/DX)	91=>	1380/1620	<b>07.0392</b>	35466648	0,591
850 all (ch. 47066-) (LH/RH-SX/DX)	94=>	1450/1680	<b>07.0393</b>	35465905	0,595
850 4WD	91=>	1890/2170	<b>07.1318</b>	9157684-9209757	0,834
940-960 all (LH-SX)	94=>	1390/2200	<b>07.0394</b>	91409805	0,902
940-960 all (LH-SX)	87=>	1615/2210	<b>07.291</b>	13877873-3530621-68193820	0,814
940-960 all (RH-DX)	87=>	910	<b>07.292</b>	13877881-3530622	0,070
940-960 all (LH-SX)	97=>	1825/2065	<b>07.1032</b>	91409790	0,908
940-960 all (RH-DX)	97=>	360/750	<b>07.1656</b>	9157231	0,178

<b>ZASTAVA</b>					
Jugo 45	83=>	1190+1190/ 2745	<b>07.256</b>	4402683-4402688	0,969
Florida/Miami	89=>	1390+1390/ 3190	<b>07.293</b>	46617663-46617666	•
128	07/71=>	765+765/ 2030	<b>07.122</b>	4261121-4261122	0,699
1300		760+760/ 2770	<b>07.137</b>	4060599	0,818









**automotive products**

**COMANDI ACCELERATORE A MANO  
HAND ACCELERATOR CABLES  
TIRETTES DE STARTER  
VERGASERZUGE  
CABLES DE ACCELERADOR DE  
MANO  
CABOS DE ACELERADOR DE MAO  
RĘCZNE LINKI GAZU  
LANKA RUČNÍHO AKCELERÁTORU  
ТРОСЫ РУЧНОГО УПРАВЛЕНИЯ  
ДРОССЕЛЬНОЙ ЗАСЛОНКОЙ**

FIAT..... pag. 147

COMANDI ACCELERATORE A MANO - HAND ACCELERATOR CABLES - TIRETTES DE STARTER  
 VERGASERZUGE - CABLES DE ACCELERADOR DE MANO - CABOS DE ACELERADOR DE MAO  
 RĘCZNE LINKI GAZU - LANKA RUČNÍHO AKCELERÁTORU  
 ТРОСЫ РУЧНОГО УПРАВЛЕНИЯ ДРОСсельНОЙ ЗАСЛОНКОЙ

				OEM REF.	
<b>FIAT</b>					
126		650/800	<b>08.180</b>	4365816	0,104
Tipo D/TD	88=>		<b>08.263</b>	181468780	•
 					
<b>FIAT - Commercial Vehicle</b>					
Ducato D	88=>	675/825	<b>08.264</b>	7537527	0,092



**automotive products**

**FUNICELLE ALZACRISTALLO  
STEEL CABLES FOR WINDOW  
CABLES DE LEVE GLACE  
CABOS DE ELEVADOR VIDRO  
STALOWE LINKI DO MECHANIZMU  
PODNOSZENIA OKNA  
OCELOVÁ LANKA PRO OKNO  
СТАЛЬНЫЕ ТРОСЫ ДЛЯ  
СТЕКЛОПОДЪЕМНИКОВ**

FIAT..... pag. 148

FUNICELLE ALZACRISTALLO - STEEL CABLES FOR WINDOW - CABLES DE LEVE GLACE  
 CABOS DE ELEVADOR VIDRO - STALOWE LINKI DO MECHANIZMU PODNOSZENIA OKNA  
 OCELOVÁ LANKA PRO OKNO - СТАЛЬНЫЕ ТРОСЫ ДЛЯ СТЕКЛОПОДЪЕМНИКОВ



OEM REF.



**FIAT**

N500 (front-avt)		3950	<b>19.100</b>		•
N500 Giardiniera (front-avt)		3750	<b>19.101</b>	975357	•
126 (front-avt)		2272	<b>19.110</b>	4299265	•
600 (front-avt)		3040	<b>19.102</b>	4001795	•
600 D (front-avt)		2370	<b>19.103</b>	4066508	•
600 T (front-avt)		1920	<b>19.104</b>	4055687	•
850 Berlina-Super (front-avt)		2380	<b>19.105</b>	4109359	•
1100 D-R (front-avt)		1920	<b>19.104</b>	4055687-4166274	•
124/125 (front-avt)		2300	<b>19.108</b>	4142620-4266080	•
124/125		2240	<b>19.111</b>	4266079	•



**automotive products**

**TRASMISSIONI FLESSIBILI  
CONTACHILOMETRI  
SPEEDOMETER CABLES  
CABLES DE COMPTEUR  
TACHOMETERWELLEN  
FLEXIBLES VELOCIMETROS  
CABOS C/KILOMETROS  
LINKI SZYBKOŚCIOMIERZA  
LANKA RYCHLOMĚRU  
ТРОСЫ СПИДОМЕТРА**

ALFA ROMEO .....	pag. 149
ARO .....	pag. 149-150
AUDI .....	pag. 150
BMW .....	pag. 150
CITROEN .....	pag. 150-152
FIAT .....	pag. 152-156
FORD .....	pag. 157
HONDA .....	pag. 157-158
HYUNDAI .....	pag. 158
INNOCENTI .....	pag. 158
LADA VAZ .....	pag. 158
LANCIA .....	pag. 159-160
MERCEDES .....	pag. 160
MITSUBISHI .....	pag. 160
NISSAN .....	pag. 160
OPEL .....	pag. 161
PEUGEOT .....	pag. 162-163
POLSKI .....	pag. 163
RENAULT .....	pag. 163-165
ROVER .....	pag. 165
SEAT .....	pag. 165-166
SKODA .....	pag. 166
SUZUKI .....	pag. 166
TALBOT .....	pag. 166-167
TOYOTA .....	pag. 167
VOLKSWAGEN .....	pag. 167-168
VOLVO .....	pag. 168
ZASTAVA .....	pag. 168

**TRASMISSIONI FLESSIBILI CONTACHILOMETRI - SPEEDOMETER CABLES - CABLES DE COMPTEUR  
TACHOMETERWELLEN - FLEXIBLES VELOCIMETROS - CABOS C/KILOMETROS  
LINKI SZYBKOŚCIOMIERZA - LANKA RYCHŁOMĚRU - ТРОСЫ СПИДОМЕТРА**



					OEM REF.	
<b>ALFA ROMEO</b>						
Alfasud all	=>82	1652	1A+3C	<b>32.101</b>	510635-60744144-510636	0,315
Alfasud all	83=>	1660	1A+3C	<b>32.105</b>	537421	0,322
Arna		1459	6F+3C	<b>32.102</b>	547353	0,315
Giulia Super		1882	1A+2B	<b>32.149</b>	105006450000-105006450030	0,339
Giulia 1,6		1744	1A+2B	<b>32.145</b>	105146450000	0,347
Giulia 1,3-1,6		1789	1A+2B	<b>32.147</b>	105006450026	•
Giulia Ti		1810	1A+2B	<b>32.157</b>	105006450027	•
Giulia GT/Junior		1887	1A+2B	<b>32.153</b>	105006450028	0,372
1750		1789	1A+2B	<b>32.147</b>	105006450026	•
1750		1810	1A+2B	<b>32.157</b>	105006450027	•
1750 GTV		1887	1A+2B	<b>32.153</b>	105006450028	0,372
1750 Spyder		1882	1A+2B	<b>32.149</b>	105006450000-105006450030	0,339
Giulietta 1,3-1,6-1,8		2915	5E+4D	<b>32.127</b>	116506450001-116556450000	0,566
Alfetta 1,6-1,8	=>83	2940	1A+4D	<b>32.203</b>	116086450001	0,611
Alfetta 1,6-1,8-2,0	83=>	2915	5E+4D	<b>32.127</b>	116556450000-116426450010	0,566
Alfetta GT-GTV		2960	5E+4D	<b>32.123</b>	116106450051-60726496 60727043	0,562
2000		1882	1A+2B	<b>32.149</b>	105006450000-105006450030	0,339
2000 GTV Coupé-Spyder		1998	1A+2B	<b>32.133</b>	105006450006-60710520	0,389
2000 Spyder	91=>	805	2B+2B1	<b>32.250</b>	60554799	0,325
2000 (USA model)	77=>81	1940	1A+2B	<b>32.169</b>	115336450001-60713330	0,387
2000 (USA model) (gear side)		1197	1A+2B	<b>32.171</b>	115446450200-60723086	0,237
2000 (USA model) (instrument side)		975	1A+13M	<b>32.173</b>	115446450000-60723085	0,196

<b>TACHOMETERS</b>						
Giulia		1268	1A+2B	<b>32.143</b>	105006450127	0,257
Giulia Super		1325	1A+2B	<b>32.155</b>	105006450129	0,268
Giulia 1,6-GT		1410	1A+2B	<b>32.151</b>	105006450128	0,271
1750 GTV/1750 Spyder		1325	1A+2B	<b>32.155</b>	105006450129	0,268
1750 GTV/1750 Spyder		1410	1A+2B	<b>32.151</b>	105006450128	0,271
2000 GTV/Spyder		1509	1A+2B	<b>32.135</b>	105126450126-60722070	•
Giulietta		1404	1A+2B	<b>32.109</b>	116006450101-116086450101	0,286
Alfetta		1404	1A+2B	<b>32.109</b>	116006450101-116086450101	0,286
Alfetta		1315	1A+2B	<b>32.111</b>	116086450102-116086450103	0,274
Alfetta GT-GTV		1310	5E+2B	<b>32.121</b>	116106450127	0,257

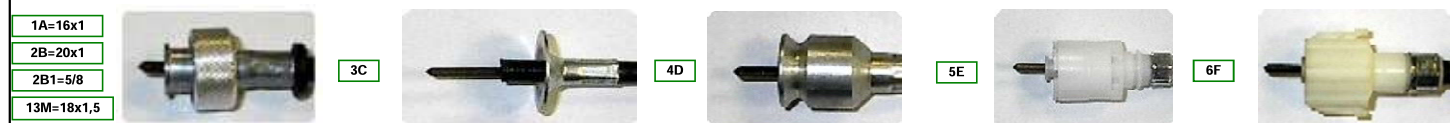

<b>ARO</b>						
Aro		1850	7G+14N	<b>45.000</b>		0,355

**TRASMISSIONI FLESSIBILI CONTACHILOMETRI - SPEEDOMETER CABLES - CABLES DE COMPTEUR  
TACHOMETERWELLEN - FLEXIBLES VELOCIMETROS - CABOS C/KILOMETROS  
LINKI SZYBKOŚCIOMIERZA - LANKA RYCHŁOMĚRU - ТРОСЫ СПИДОМЕТРА**

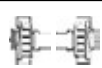

OEM REF.



**ARO**

7G=12x1



14N



**AUDI**

50	74=>	1030	13M+13M	<b>40.101</b>	861957801	0,208
80 all	74=>	1250	13M+19S	<b>40.103</b>	823957801	0,329
80 all	82=>	1260	20T+19S	<b>40.105</b>	811957801K	0,330
90 all	82=>	1260	20T+19S	<b>40.105</b>	811957801K	0,330
90 (auto trans.)		1310	20T+19S	<b>40.113</b>	443957801L	0,331
100 all	77=>	1430	13M+19S	<b>40.107</b>	433957801F	0,343
100 all	84=>	1410	20T+19S	<b>40.111</b>	443957801K	0,355

13M=18x1,5



19S



20T



**BMW**

315-316-320-320i	75=>77	1530	13M+22V	<b>31.119</b>	62211360283-62211358674	0,314
315-316-320-320i	78=>	1645	13M+22V	<b>31.111</b>	62211365371	0,398
318A-320A	78=>	1760	13M+22V	<b>31.121</b>	62211365372	0,419
320-323i (6 cyl.)	=>77	1705	13M+22V	<b>31.123</b>	62211365373	0,401
320-323i (6 cyl.)	78=>	1820	13M+22V	<b>31.125</b>	62211365374	0,428
518 (only piece)		1330	13M+22V	<b>31.117</b>	62211357768-62211355836	0,336
518 (gear side)	80=>82	1105	13M+22V	<b>31.113</b>	62211368141	0,236
520-520i (only piece)		1330	13M+22V	<b>31.117</b>	62211357768-62211355836	0,336
520 (gear side)		1165	13M+22V	<b>31.115</b>	62211368142	0,238
520 (6 cyl.)		1468	13M+22V	<b>31.127</b>	62211355837	0,296
525 (6 cyl.)		1468	13M+22V	<b>31.127</b>	62211355837	0,296
528 (6 cyl.)		1468	13M+22V	<b>31.127</b>	62211355837	0,296
Serie 3 (5 speed)	78=>83	1790	13M+22V	<b>31.109</b>	1373071	0,375

13M=18x1,5









22V



**CITROEN**

2CV all	=>79	900	7G+11K	<b>38.243</b>	95495507	0,237
2CV	79=>	800	7G+11K	<b>34.103</b>	AK5213B-5444200	0,192
Ami 6-8	63=>	690	7G+11K	<b>34.105</b>	AY5213C-95494965	0,162

**TRASMISSIONI FLESSIBILI CONTACHILOMETRI - SPEEDOMETER CABLES - CABLES DE COMPTEUR  
TACHOMETERWELLEN - FLEXIBLES VELOCIMETROS - CABOS C/KILOMETROS  
LINKI SZYBKOŚCIOMIERZA - LANKA RYCHŁOMĚRU - ТРОСЫ СПИДОМЕТРА**

					OEM REF.	
<b>CITROEN</b>						
Dyane/Acadyane	68=>	690	7G+11K	<b>34.105</b>	AY5213C-95494965	0,162
Mehari 4x4 (instrument side)		230	7G+8H	<b>34.109</b>	5491577-612235	0,073
Mehari 4x4 (gear side)	78=>	800	7G+11K	<b>34.111</b>	5491160-75491951	0,212
Mehari	79=>	800	7G+11K	<b>34.103</b>	AK5213B-5444200	0,192
Visa (652cc) (gear side)	=>02/80	790	7G+11K	<b>34.115</b>	5493282	0,215
Visa all (instrument side)	78=>	550	10J+8H	<b>34.113</b>	75491950-5490132-75513020 96074005	0,123
Visa (1124cc) (gear side)	06/80=>	950	7G+12L1	<b>34.117</b>	95496500 95592655	0,211
Visa Special (gear side)	=>02/80	800	7G+11K	<b>34.111</b>	5491160-95493346	0,212
Visa (652cc) (gear side)	03/80=>	875	7G+11K	<b>34.118</b>	75531334	0,254
Visa (1124cc) (gear side)	=>06/80	1050	7G+11K	<b>34.201</b>	95494991-75527125	0,263
Visa 650-1100cc (instrument side)	06/84=>	550	10J+8H	<b>34.113</b>	75491950-5490132-75513020 96074005	0,123
Visa GTI-D (gear side)		620	7G+25Y	<b>34.200</b>	95496646	0,073
LN-LNA (gear side)		800	7G+11K	<b>34.111</b>	5491160-95493346	0,212
LN-LNA (instrument side)		230	7G+8H	<b>34.109</b>	5491577	0,073
LN-LNA (652cc)		1050	7G+11K	<b>34.201</b>	95494991-95493211	0,263
LN-LNA (1124cc)	83=>	950	7G+12L1	<b>34.117</b>	95496500 95592655	0,211
Axel (instrument side)	84=>	485	10J+8H	<b>34.129</b>	95493937	0,115
Axel (gear side)	84=>	550	7G+11K	<b>34.131</b>	95493938	0,183
AX all (instrument side)	=>86	550	10J+8H	<b>34.113</b>	75491950-5490132-75513020 96074005	0,123
AX all (gear side)	=>05/91	300	7G+25Y	<b>34.126</b>	96089902-95630472	0,079
AX (-ch. 4834) (instrument side)	86=>91	495	10J+8H	<b>34.134</b>	96041751-95630473-96144885	0,108
AX all (instrument side)	06/91=>	310	10J+8H	<b>34.165</b>	96139395-96090652	0,073
AX all (gear side)	06/91=>	620	7G+25Y1	<b>34.170</b>	96073712	0,151
AX all (instrument side)	=>05/91	590	10J+8H	<b>34.153</b>	96002885	0,149
AX Sport (instrument side)	=>91	620	10J+8H	<b>34.122</b>	95638113-95600677	0,135
AX all (ch. 6175-)	91=>	900	10J+25Y	<b>24.148</b>	6123G2	0,216
ZX all (-ch. 5347) (instrument side)		550	10J+8H	<b>34.113</b>	75491950-5490132-75513020 96074005	0,123
ZX BZ-D (ch. 5348-) (instrument side)	91=>	590	10J+8H	<b>34.153</b>	96147546-96002885-96047055	0,149
ZX BZ all (gear side)	91=>	423	7G+25Y	<b>34.155</b>	96128130	0,106
ZX D all (gear side)	93=>	592	7G+25Y1	<b>34.157</b>	96142943	0,149
GS 4 speed	75=>	1040	10J+11K	<b>34.119</b>	5491172-95493148	0,239
GSA 4 speed	75=>	1040	10J+11K	<b>34.119</b>	5491172-95493148	0,239
GSA 5 speed		950	10J+11K	<b>34.106</b>	95493031	0,205
BX all (instrument side)	82=>	550	10J+8H	<b>34.113</b>	75491950-5490132-75513020 96074005	0,123
BX 14 (gear side)	82=>	570	7G+12L1	<b>34.121</b>	95583772	0,123
BX 14-16-19 (-ch. 4724) (gear side)		485	7G+25Y	<b>34.120</b>	95566607	0,113
BX 14-16-19 (ch. 4725-) (gear side)		300	7G+25Y	<b>34.126</b>	96089902-95630472	0,079
BX all (instrument side)	86=>	620	10J+8H	<b>34.122</b>	95638113-95600677	0,135
BX 16 Sport (gear side)	86=>	515	7G+25Y	<b>34.123</b>	95496555	0,115
BX 16-19 (gear side)	=>86	460	7G+25Y	<b>34.108</b>	95494967-95496541	0,109
Xantia	93=>	910	10J3+25Y	<b>34.124</b>	96163009	0,201

**TRASMISSIONI FLESSIBILI CONTACHILOMETRI - SPEEDOMETER CABLES - CABLES DE COMPTEUR  
TACHOMETERWELLEN - FLEXIBLES VELOCIMETROS - CABOS C/KILOMETROS  
LINKI SZYBKOŚCIOMIERZA - LANKA RYCHŁOMĚRU - ТРОСЫ СПИДОМЕТРА**



**CITROEN**

CX 4 speed (instrument side)		550	10J+8H	<b>34.113</b>	75491950-5490132-75513020 96074005	0,123
CX 4 speed (gear side)		690	7G+11K	<b>34.105</b>	75491654-95494965	0,162
CX 5 speed (gear side)		970	7G+11K	<b>34.110</b>	75491627	0,226
CX 5 speed (instrument side)		270	10J+8H	<b>34.112</b>	95492738-75491143	0,065
XM (-ch. 4834) (instrument side)		495	10J+8H	<b>34.134</b>	96041751-95630473-96144885	0,108
XM (ch. 4835-) (instrument side)		480	10J+7G	<b>34.202</b>	96102827	0,115
XM all (gear side)		485	7G+25Y	<b>34.120</b>	95566607-96073325	0,113
Evasion	95=>	1137	25Y1+10J4	<b>38.531</b>	6123H0-6123L1	0,273



**CITROEN - Commercial Vehicle**



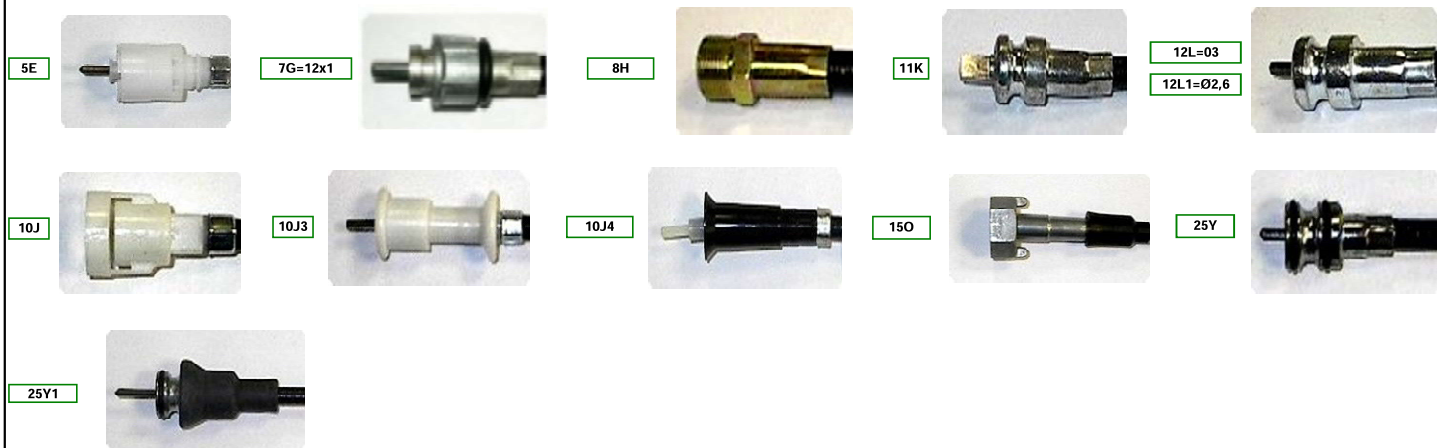



Jumpy	95=>	1137	25Y1+10J4	<b>38.531</b>	6123H0-6123L1	0,273
C15 BZ 1,1-1,3 (-ch. 4237)		450	7G+25Y	<b>34.120</b>	95566607	0,113
C15 (gear side)		450	7G+25Y	<b>34.120</b>	95566607	0,113
C15 (instrument side)		550	10J+8H	<b>34.113</b>	75491950-75513020	0,123
C15 BZ (gear side)		950	7G+12L1	<b>34.117</b>	95496500 95592655	0,211
C15 BZ (ch. -4833) (gear side)		300	7G+25Y	<b>34.126</b>	96089902	0,079
C15 D		620	7G+25Y	<b>34.200</b>	95496646	0,073
Jumper BZ	=>02/95	1510	5E+15O	<b>34.159</b>	6123G6-6123K6	0,370
Jumper BZ 10/14	02/95=>	1510	5E+15O	<b>34.159</b>	6123G6-6123K6	0,370
Jumper DS-TDS	02/95=>	1412	5E+25Y1	<b>34.161</b>	6123K7	0,324
Jumper DS-TDS		1512	5E+25Y1	<b>34.128</b>	6123G8-6123K2	0,342
Jumper BZ 18	02/95=>	1410	5E+15O	<b>34.160</b>	6123K3	0,342
C32-C35 (instrument side)	=>10/83	1865	7G+8H	<b>38.277</b>	5514465-5444201	0,393
C32-C35 (gear side)	=>10/83	760	7G+11K	<b>38.279</b>	5444200	0,192
C32-C35 (instrument side)	10/83=>	1895	10J+8H	<b>38.253</b>	95595611	0,372
C32-C35 (gear side)	10/83=>	910	7G+11K	<b>38.243</b>	95495507	0,237









**FIAT**

500 D-Giardiniera		2850	1A+13M	<b>38.129</b>	4095747-4096541	0,511
500 F-L		2575	1A+13M	<b>38.121</b>	4134526-4206651	0,531

**TRASMISSIONI FLESSIBILI CONTACHILOMETRI - SPEEDOMETER CABLES - CABLES DE COMPTEUR  
TACHOMETERWELLEN - FLEXIBLES VELOCIMETROS - CABOS C/KILOMETROS  
LINKI SZYBKÓŚCIOMIERZA - LANKA RYCHŁOMĚRU - ТРОСЫ СПИДОМЕТРА**

					OEM REF.	
<b>FIAT</b>						
500 R		2480	1A+13M	<b>38.165</b>	4310089	0,466
500 F-Giardiniera		2675	1A+13M	<b>38.131</b>	4122850	0,503
500D		2750	1A+13M	<b>38.631</b>	4070427	•
126 all	76=>	2480	1A+13M	<b>38.165</b>	4310089-4321867	0,466
126 (nottolino nylon)	76=>	2480	1A+13M	<b>38.123</b>	4321867-4310089	0,515
126 Bis	85=>	2515	1A+13M	<b>38.101</b>	7536340	0,510
Cinquecento (700cc) (instrument side)	92=>	520	1A+9I	<b>38.571</b>	7698249	0,190
Cinquecento (700cc) (gear side)	92=>	400	5E+13M1	<b>38.573</b>	7698246	0,108
Cinquecento (900cc) (instrument side)	92=>	390	1A+9I	<b>38.575</b>	7698255-7791441	0,101
Cinquecento (900cc) (gear side)	92=>	600	5E+13M1	<b>38.577</b>	7698252-7798137	0,148
Cinquecento Sporting	95=>	1010	5E+1A5	<b>38.581</b>	46411963-46463755	0,244
Cinquecento (700-900cc)		1007	5E+13M1	<b>38.622</b>	46404776-46463753	0,227
600 D-E		2440	1A+13M	<b>38.139</b>	4065741-4094607	0,495
Seicento all 900 Spi	98=>	1100R	5E+13M1	<b>38.579</b>	46511571	0,223
Seicento all 1108	98=>	1120R	5E+1A3	<b>38.588</b>	46511572	0,250
Seicento 900cc (gear side)	98=>	460	13M1+13M	<b>38.626</b>	46513095	0,116
Seicento 900cc (instrument side)	98=>	1320	5E+13M1	<b>38.627</b>	46513096	0,429
850 (II s.)	67=>	2455	1A+14N	<b>38.155</b>	4136084	0,472
Panda 30		1385	5E+13M	<b>38.103</b>	4413858	0,305
Panda 30 (II s.)		1165	5E+13M	<b>38.507</b>	4413851	0,259
Panda 30 (II s.)		1127	5E+13M	<b>38.543</b>	5933292	0,254
Panda 45 Young		900	5E+13M	<b>38.105</b>	4413859-7635491	0,216
Panda 45/750/1000-4x4-D	03/88=>	900	5E+13M	<b>38.105</b>	4413859-7635491	0,216
Panda Restyling	90=>	920	5E+13M1	<b>38.628</b>	46444815	0,248
127 all		752	1A+13M	<b>38.167</b>	4243289-4345582	0,169
127 (900cc)	=>82	752	5E+13M	<b>38.173</b>	4406336	0,176
127 (1050cc)	=>82	810	5E+13M	<b>38.171</b>	4379747	0,182
127 (900-1050cc)	82=>	710	5E+13M	<b>38.169</b>	5960316-5939198	0,169
127 D		875	13M+13M	<b>38.177</b>	4349763	0,178
147 Brasil		875	13M+13M	<b>38.177</b>	4349763	0,178
Uno all	=>87	930	5E+13M	<b>38.115</b>	5934788-7640904	0,198
Uno Turbo ie	=>89	1030	5E+13M	<b>38.511</b>	7556232-7635497-7682313	0,229
Uno R89 1,3-1,5 cat.		890	5E+13M1	<b>38.555</b>	7635494-7736874	0,223
Uno R89 (900-1000cc)		930	5E+13M1	<b>38.132</b>	7736875	0,239
Uno all	88=>	890	5E+13M	<b>38.551</b>	7613810	0,199
Uno D-TD	89=>	930	5E+13M	<b>38.115</b>	7674244	0,198
Uno	93=>	1090	5E+1A5	<b>38.580</b>	7761531	0,271
Uno all 1100-1108cc	09/93=>	1030	5E+1A3	<b>38.511/1</b>	7785023	0,253
Uno CS	88=>91	1100	5E+13M1	<b>38.621</b>	7765605-50004846	0,286
Uno CS	87=>	1100	5E+13M	<b>38.501</b>	7587072-7656640-7706788	0,274
Duna	87=>	1100	5E+13M	<b>38.501</b>	7587072	0,274
Duna	86=>90	1100	5E+13M1	<b>38.621</b>	7765605-50004846	0,286
Duna	90=>	1105	5E+13M1	<b>38.629</b>	7657568	0,305

**TRASMISSIONI FLESSIBILI CONTACHILOMETRI - SPEEDOMETER CABLES - CABLES DE COMPTEUR  
TACHOMETERWELLEN - FLEXIBLES VELOCIMETROS - CABOS C/KILOMETROS  
LINKI SZYBKOŚCIOMIERZA - LANKA RYCHŁOMĚRU - ТРОСЫ СПИДОМЕТРА**

					OEM REF.	
<b>FIAT</b>						
Premio		1100	5E+13M	<b>38.501</b>	7521023	0,274
Punto 55-60-75 (6 speed)	11/93=>	1115	1A3+4D2	<b>38.530</b>	7739414-46424537-464624537	0,280
Palio/Siena	97=>	900	5E+1A4	<b>38.620</b>	46401201	0,240
128		902	1A+13M	<b>38.181</b>	4206815	0,148
128 Special-3P-Rally-Sport		1037	1A+13M	<b>38.189</b>	4327531-4344131-4264558	0,423
128 C-CL		1082	5E+13M	<b>38.195</b>	4370256	0,236
X 1/9		3300	1A+13M	<b>38.241</b>	4266710-4397278	0,618
X 1/9		3660	1A+13M	<b>38.249</b>	4299074 (FP:Anello di fermo in plastica)	0,698
X 1/9 (5 speed)		3200	5E+13M	<b>38.556</b>	5920908-59209010	0,612
1100 D-R		1037	1A+13M	<b>38.259</b>	4039718	0,216
Ritmo		1270	5E+13M	<b>38.113</b>	4383351-5981382	0,279
Ritmo TD		1110	5E+13M	<b>38.107</b>	5981987	0,232
Ritmo (auto trans.)		1390	5E+13M	<b>38.111</b>	4428922	0,268
Tipo mod.base (instrument side)	88=>	469	5E+16P	<b>38.520</b>	7601995	0,114
Tipo mod.base (gear side)	88=>	446	5E+13M	<b>38.519</b>	7648188-7602006	0,104
Tipo	92=>	972	5E+13M1	<b>38.525</b>	7726207	0,235
Tipo (modif.)	88=>91	1010	5E+13M	<b>38.610</b>	7601995-7602006-7648188	0,211
124		1090	1A+13M	<b>38.197</b>	4135444	0,246
124 S-ST		1130	1A+13M	<b>38.199</b>	4215400-4155481	0,228
124 Spyder	=>75	1240	1A+13M	<b>38.213</b>	4181687	0,269
124 Spyder	76=>	1240	5E+13M	<b>38.207</b>	4399453	0,262
124 Spyder-Europa	82=>	1650	5E+13M	<b>38.297</b>	4419098	0,355
131 all		1680	5E+13M	<b>38.221</b>	5983717-4338097-4375961	0,337
131 (auto trans.)		1770	5E+13M	<b>38.223</b>	4338219-5980997	0,374
Regata		1110	5E+13M	<b>38.107</b>	5981987	0,232
Regata		1270	5E+13M	<b>38.113</b>	4383351-5981382	0,279
Regata (auto trans.)		1390	5E+13M	<b>38.111</b>	4428922	0,268
Regata D-TD		1370	5E+13M	<b>38.541</b>	7578136	0,314
Tempra (instrument side)	88=>	469	5E+16P	<b>38.520</b>	7601995	0,114
Tempra 1,4-1,6-1,8-D (gear side)	90=>91	446	5E+13M	<b>38.519</b>	7648188-7602006	0,104
Tempra	92=>	972	5E+13M1	<b>38.525</b>	7726207	0,235
Tempra (modif.)	88=>91	1010	5E+13M	<b>38.610</b>	7601995-7602006-7648188	0,211
1300-1500		1037	1A+13M	<b>38.259</b>	4039718	0,216
125		1130	1A+13M	<b>38.199</b>	4155481	0,228
132 all (4 speed)		1490	1A+13M	<b>38.235</b>	4290057-4324438	0,313
132 all (5 speed)		1400	1A+13M	<b>38.237</b>	4273689-4326282-4290062	0,291
132 D		1490	5E+13M	<b>38.239</b>	4388154-5980868	0,316
Argenta		1490	5E+13M	<b>38.239</b>	4388154-5980868	0,316

**TRASMISSIONI FLESSIBILI CONTACHILOMETRI - SPEEDOMETER CABLES - CABLES DE COMPTEUR  
TACHOMETERWELLEN - FLEXIBLES VELOCIMETROS - CABOS C/KILOMETROS  
LINKI SZYBKOSCMIERZA - LANKA RYCHLOMĚRU - ТРОСЫ СПИДОМЕТРА**



**FIAT**

Croma all		1290	5E+13M	<b>38.351</b>	82382699	0,261
Croma all	87=>	1250	5E+13M	<b>38.547</b>	82428992	0,253
Ulysse	95=>	1135	25Y+10J4	<b>38.531</b>	9618182680-6123H0-6123L1	0,273



**FIAT - Commercial Vehicle**

600 T		3160	1A+13M	<b>38.145</b>	4066176	0,623
850 T/900 T		3334	1A+14N	<b>38.161</b>	4242257	0,591
900 E		3334	5E+14N	<b>38.163</b>	4450401	0,586
Fiorino (900cc)	=>82	752	5E+13M	<b>38.173</b>	4406336	0,176
Fiorino (1050cc)	=>82	810	5E+13M	<b>38.171</b>	4379747	0,182
Fiorino	=>87	892	13M+13M	<b>38.535</b>	7506964	0,195
Fiorino	88=>	1100	5E+13M	<b>38.501</b>	7587072	0,274
Fiorino	90=>	1105	5E+13M1	<b>38.629</b>	7657568	0,305
Fiorino 1,7 BZ	96=>	1100	5E+13M1	<b>38.621</b>	7765605-50004846	0,286
Fiorino 1,7 TDS	96=>	1160	5E+13M1	<b>38.630</b>	50009893	0,303
Scudo all	95=>	1135	25Y+10J4	<b>38.531</b>	9618182680-6123H0-6123L1	0,273
242 (gear side)		763	7G+11K	<b>38.279</b>	5444200	0,192
242 (gear side)	79=>	920	7G+11K	<b>38.243</b>	95495507	0,237
242 (instrument side)	=>83	1865	7G+8H	<b>38.277</b>	5514465	0,393
242 (instrument side)	83=>	1890	10J+8H	<b>38.253</b>	5595611	0,372
Ducato	=>88	1231	5E+17Q	<b>38.281</b>	5950294-7567798	0,277
Ducato D-TD/Talento		1227	5E+17Q1	<b>38.537</b>	7617383	0,279
Ducato all	91=>	1349	5E+17Q1	<b>38.557</b>	7745213-6123C7-7666874	0,114
Ducato	07/93=>	1350	5E+15O	<b>38.282</b>	7780909-6123G4	0,353
Ducato (gear ME)	94=>	1510	5E+15O	<b>34.159</b>	6123G6-6123K6-1315805080 1306982080	0,370
Ducato (gear MG)	94=>	1412	5E+25Y1	<b>34.161</b>	1315808080-1307439080-6123K7	0,324
Ducato (gear ME)	94=>	1512	5E+25Y1	<b>34.128</b>	1315809080-6123G8-6123K2	0,342
Ducato (gear MG)	94=>	1410	5E+15O	<b>34.160</b>	6123K3-1315807080	0,342
Daily/Grinta 35		3050	5E1+15O	<b>38.623</b>	93802485	0,634
Daily/Grinta 40		3300	1A+15O	<b>38.624</b>	93803627	0,661
Daily	85=>	1810	1A+15O	<b>38.625</b>	4778898	0,400
Daily/Grinta 30-32		2185	1A+15O	<b>32.207</b>	93803625-93803626	0,647

1A=16x1



1A3=18x1,5



1A4=18x1,5



1A5=18x1,5



**TRASMISSIONI FLESSIBILI CONTACHILOMETRI - SPEEDOMETER CABLES - CABLES DE COMPTEUR  
TACHOMETERWELLEN - FLEXIBLES VELOCIMETROS - CABOS C/KILOMETROS  
LINKI SZYBKOŚCIOMIERZA - LANKA RYCHŁOMĚRU - ТРОСЫ СПИДОМЕТРА**



OEM REF.



**FIAT - Commercial Vehicle**

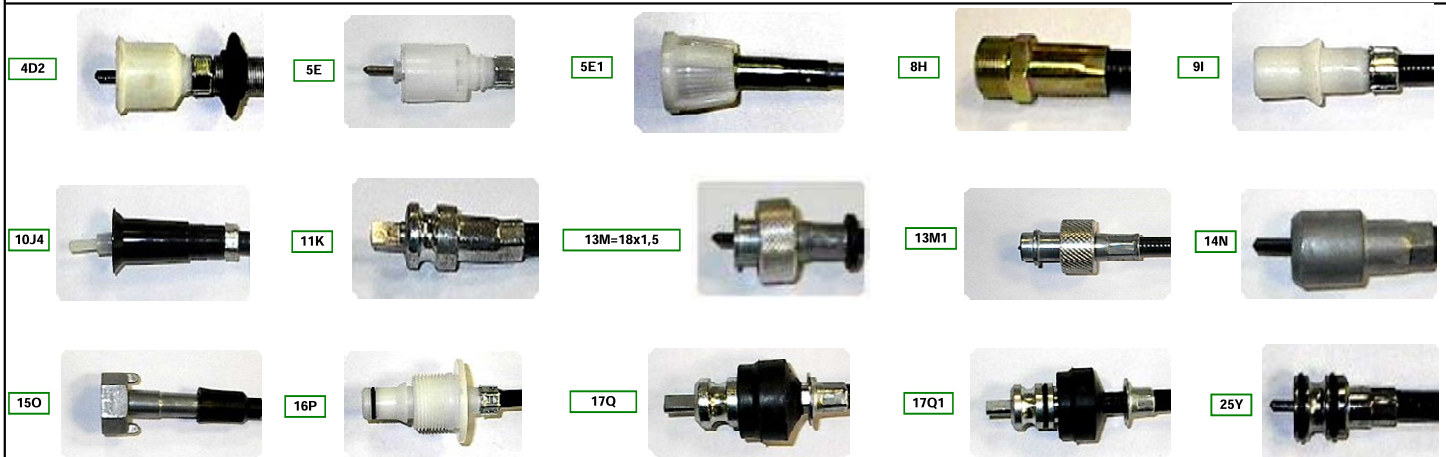

**FLESSIBILI INTERNI - INNER CABLES**

500 R		2480		<b>38.164</b>		•
500 F-L		2575		<b>38.120</b>		•
126		2480		<b>38.164</b>		•
126 Personal (nott. Nylon)		2480		<b>38.122</b>		•
126 Bis		2515		<b>38.100</b>		•
850		2480		<b>38.164</b>		•
Cinquecento 700cc (gear side)		340		<b>38.572</b>		•
Cinquecento 700cc (instrument side)		520		<b>38.574</b>		•
Cinquecento 900cc (gear side)		600		<b>38.576</b>		•
Cinquecento 900cc (instrument side)		390		<b>38.578</b>		•
Panda 30		1385		<b>38.102</b>		•
Panda 30 (II° s.)		1165		<b>38.506</b>		•
Panda 30		1127		<b>38.542</b>		•
Panda 45-750-1000		900		<b>38.104</b>		•
Uno all		890		<b>38.550</b>		•
Uno Turbo ie - Uno 1,5		1030		<b>38.510</b>		•
Uno CS		1100		<b>38.500</b>		•
Duna		1100		<b>38.500</b>		•
Tipo (mod.base) (instrument side)		469		<b>38.514</b>		•
Tipo (mod.base) (gear side)		446		<b>38.518</b>		•
Tipo	91=>	972		<b>38.526</b>		•
Ritmo all		1272		<b>38.112</b>		•
Ritmo Turbo		1110		<b>38.106</b>		•
Regata all		1110		<b>38.106</b>		•
Regata		1272		<b>38.112</b>		•
Regata D-TD		1370		<b>38.540</b>		•
Fiorino		1100		<b>38.500</b>		•

**TRASMISSIONI FLESSIBILI CONTACHILOMETRI - SPEEDOMETER CABLES - CABLES DE COMPTEUR  
TACHOMETERWELLEN - FLEXIBLES VELOCIMETROS - CABOS C/KILOMETROS  
LINKI SZYBKÓŚCIOMIERZA - LANKA RYCHŁOMĚRU - ТРОСЫ СПИДОМЕТРА**



<b>FORD</b>						
Fiesta	=>83	870	18R+13M	<b>35.113</b>	6059131-6038841	0,179
Fiesta	84=>	995	18R+13M	<b>35.137</b>	6135499	0,210
Fiesta (without sensor)	89=>	850	18R+13M	<b>35.200</b>	6163213	0,176
Fiesta (with sensor)	89=>	790	18R+13M	<b>35.205</b>	6163214-6159446	0,167
Escort all	=>78	1855	18R+3C2	<b>35.107</b>	1426438-1547027	0,383
Escort all	78=>	1995	18R+3C2	<b>35.109</b>	6060509	0,389
Escort	80=>	1004	18R+13M	<b>35.111</b>	1591745	0,202
Escort	86=>	850	18R+13M	<b>35.200</b>	6159444	0,176
Escort (instrument side)	86=>	502	18R+13M	<b>35.157</b>	1643275	0,117
Escort (computer)	86=>	790	18R+13M	<b>35.205</b>	6163214-6159446	0,167
Escort all	90=>	1195	18R+13M	<b>35.163</b>	6483328	0,247
Orion	80=>	1004 R	18R+13M	<b>35.111</b>	1591745	0,202
Orion	86=>	850	18R+13M	<b>35.200</b>	6159444	0,176
Orion (instrument side)	86=>	502	18R+13M	<b>35.157</b>	1643275	0,117
Orion (computer)	86=>	790	18R+13M	<b>35.205</b>	6163214-6159446	0,167
Capri		2310	18R+3C2	<b>35.101</b>	1444627	0,433
Capri (II° S.)		2465	18R+3C2	<b>35.103</b>	6011872	0,438
Taurus		1785	18R+3C2	<b>35.117</b>	1476152	0,341
Taurus	73=>	2100	18R+3C2	<b>35.119</b>	1547024-6011881	0,405
Granada	78=>	2100	18R+3C2	<b>35.119</b>	1547024-6011881	0,405
Sierra (4 speed)	83=>	2623	18R+3C2	<b>35.127</b>	6115152	0,493
Sierra (5 speed)	83=>	2756	18R+3C2	<b>35.129</b>	6115156	0,518
Sierra (4 speed)	87=>	2805	18R+3C2	<b>35.141</b>	6151483	0,531
Sierra (5 speed)	87=>	2940	18R+3C2	<b>35.142</b>	6151472	0,589



**FORD - Commercial Vehicle**

Transit	=>78	2210	18R+3C3	<b>35.121</b>	1492135-1467929	0,445
Transit	79=>	2555	18R+3C3	<b>35.123</b>	6061219	0,477
Transit	80=>	2375	18R+3C3	<b>35.125</b>	6081927-78V17260BC	0,462
Transit (with overdrive)	=>88	2540	18R+3C3	<b>35.143</b>	6128560-83VB7260BA	0,489
Transit (with overdrive)	88=>	2665	18R+3C3	<b>35.145</b>	6170017-86VB7260KC	0,547
Transit	88=>	2395	18R+13M	<b>35.147</b>	6156796-86VB7260DB	0,473



13M=18x1,5

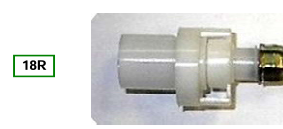

**HONDA**

Civic-Civic Wagon	81=>	1245	10J6+26Z	<b>20.004</b>	37230SA0661	0,220
Civic w/MT (exc. SI-Wagon)	84=>87	999	10J6+26Z	<b>20.005</b>	37230SB3672	0,171
Civic SI	86=>87	999	10J6+26Z	<b>20.005</b>	37230SB3672	0,171
Civic w/AT (exc. Wagon)	84=>87	999	10J6+26Z	<b>20.005</b>	37230SB3672	0,171
Civic 1,3-1,6 w/MT	88=>91	883	10J6+26Z	<b>20.008</b>	78410SH3A02	0,175

**TRASMISSIONI FLESSIBILI CONTACHILOMETRI - SPEEDOMETER CABLES - CABLES DE COMPTEUR  
TACHOMETERWELLEN - FLEXIBLES VELOCIMETROS - CABOS C/KILOMETROS  
LINKI SZYBKOŚCIOMIERZA - LANKA RYCHŁOMĚRU - ТРОСЫ СПИДОМЕТРА**



					OEM REF.	
<b>HONDA</b>						
Civic 1,5 w/MT	88=>91	1203	10J6+26Z	<b>20.009</b>	78410SH3G02	0,231
Civic VTEC w/MT	90=>91	953	10J6+26Z	<b>20.010</b>	78410SH2G01	0,189
Accord w/MT	82=>83	1052	10J6+26Z	<b>20.001</b>	37230SA0680-37230SA0682	0,179
Accord w/AT	82=>83	1052	10J6+26Z	<b>20.001</b>	37230SA0680-37230SA0682	0,179
Accord w/MT	84=>	1052	10J6+26Z	<b>20.001</b>	37230SA0680-37230SA0682	0,179
CRX w/MT (exc. SI)	84=>87	999	10J6+26Z	<b>20.005</b>	37230SB3672	0,171
CRX SI	85=>87	999	10J6+26Z	<b>20.005</b>	37230SB3672	0,171

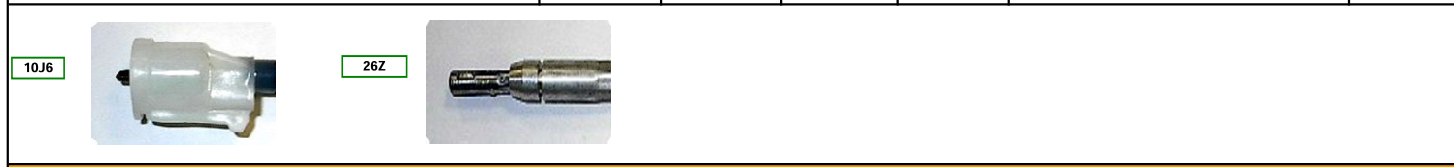

<b>HYUNDAI</b>						
Pony/Excel		903	10J6+2B4	<b>46.000</b>	9424021050	•

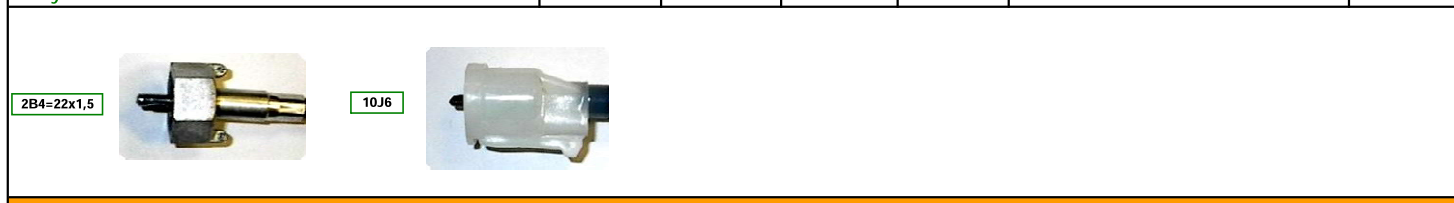





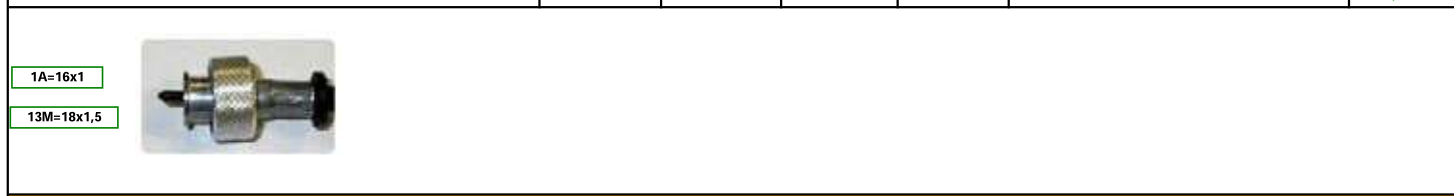

<b>INNOCENTI</b>						
Mini Minor		641	1A+2B6	<b>37.105</b>	00005077	0,138
Mini Cooper		681	1A+2B6	<b>37.103</b>	00005096	0,149
Mini 90-120-De Tomaso		822	5E+2B6	<b>37.101</b>	533611103	0,177
Mini 1000 (3 cyl.)		768	5E+2B2	<b>37.109</b>	553625103	0,182
Mini 650-T-D		800	5E+2B2	<b>37.111</b>	553620131-553622131	0,184
MiniTRE		800	5E+2B2	<b>37.111</b>	553620131-553622131	0,184



<b>LADA VAZ</b>						
2101		1092	1A+13M	<b>30.103</b>	21013802610	0,221
2103		962	1A+13M	<b>30.101</b>	21033802610	•
2105/Nova		1040	1A+13M	<b>30.105</b>	21053819010	0,218
2121/Niva		1180	1A+13M	<b>30.107</b>	21213819010	0,233
2121/Niva (new model)		1450	1A+13M	<b>30.108</b>	212123819010	0,303
Samara		802	1A+13M	<b>30.109</b>	21083819010	0,168



**TRASMISSIONI FLESSIBILI CONTACHILOMETRI - SPEEDOMETER CABLES - CABLES DE COMPTEUR  
TACHOMETERWELLEN - FLEXIBLES VELOCIMETROS - CABOS C/KILOMETROS  
LINKI SZYBKOSCMIERZA - LANKA RYCHLOMĚRU - ТРОСЫ СПИДОМЕТРА**

					OEM REF.	
<b>LANCIA</b>						
A112	=>77	854	1A+13M	<b>33.101</b>	4208502	0,198
A112	77=>	864	5E+13M	<b>33.103</b>	1120260	0,184
Y10 all	85=>	905	5E+13M	<b>33.107</b>	5993252	0,222
Y10 all	88=>	855	5E+13M	<b>33.125</b>	7632079-7706301	0,208
Y10 R92	92=>	1024	5E+13M1	<b>33.127</b>	7732776	0,249
Y10 R92 4WD	92=>	905	5E+13M1	<b>33.137</b>	7706303-7635504	0,205
Y10 (ch. 3475382-)	93=>	1030	5E+1A5	<b>33.548</b>	7757785-7757795	0,264
Delta		1070	5E+13M	<b>33.105</b>	82350456-82402196	0,236
Delta	86=>	990	5E+13M	<b>33.119</b>	82431200-82386396	0,202
Delta ie TD		990	5E+13M	<b>33.119</b>	82431200	0,202
Delta 4WD (instrument side)	88=>	637	5E+9I	<b>33.121</b>	82430505	0,147
Delta 4WD (gear side)	88=>	430	5E+13M	<b>33.123</b>	82430504	0,100
Prisma	86=>	990	5E+13M	<b>33.119</b>	82431200-82386396	0,202
Dedra 1,6-2,0-TD (instrument side)	89=>	574	5E+16P	<b>33.129</b>	82441710	0,130
Dedra 1,6-2,0-TD (gear side)	89=>	446	5E+13M1	<b>38.519</b>	7602006	0,104
Dedra 1,6-2,0-TD (antiskid)	89=>	391	5E+13M	<b>33.133</b>	82455520	0,091
Dedra 1,8-2,0	92=>	972	5E+13M1	<b>38.525</b>	7726207	0,235
Fulvia 2C/Coupé		800	1A+13M	<b>33.113</b>	82176283	•
Fulvia (5 speed)/Coupé		1008	1A+13M	<b>33.109</b>	82300027	•
Fulvia Coupé HF		958	1A+13M	<b>33.111</b>	82198600	•
Beta		1070	5E+13M	<b>33.105</b>	82350456-82402196	0,236
Trevi		1070	5E+13M	<b>33.105</b>	82350456-82402196	0,236
Gamma all		1130	1A+13M	<b>38.199</b>	82311199	0,228
Thema	86=>	1290	5E+13M	<b>38.351</b>	82382699	0,261
Thema	87=>	1250	5E+13M	<b>38.547</b>	82428992	0,253
Zeta		1135	25Y+10J4	<b>38.531</b>	9618182680-6123H0-6123L1	0,273

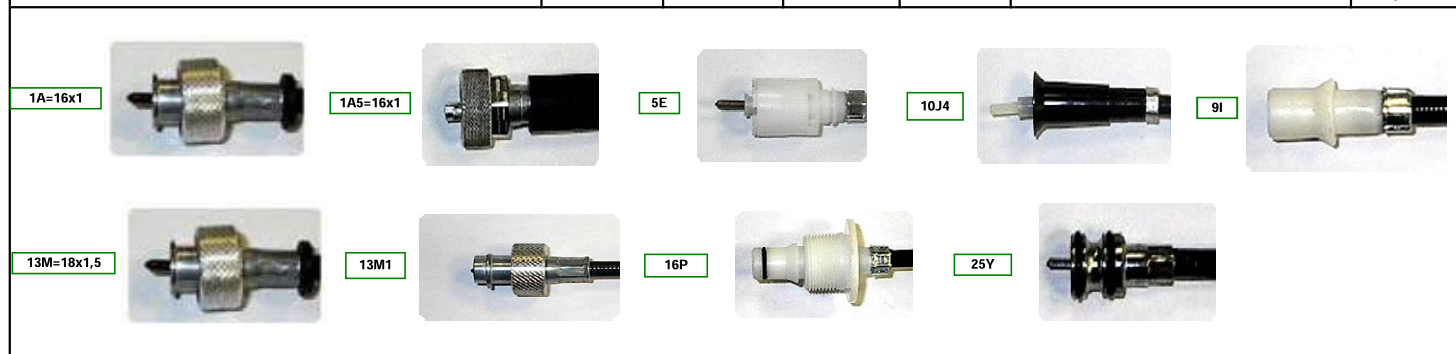

<b>FLESSIBILI INTERNI - INNER CABLES</b>						
A112	77=>	864		<b>33.102</b>		•
Y10		905		<b>33.106</b>		•
Y10		855		<b>33.532</b>		•
Delta		1070		<b>33.104</b>		•
Delta		990		<b>33.118</b>		•

**TRASMISSIONI FLESSIBILI CONTACHILOMETRI - SPEEDOMETER CABLES - CABLES DE COMPTEUR  
TACHOMETERWELLEN - FLEXIBLES VELOCIMETROS - CABOS C/KILOMETROS  
LINKI SZYBKOSCMIERZA - LANKA RYCHLOMĚRU - ТРОСЫ СПИДОМЕТРА**



**FLESSIBILI INTERNI - INNER CABLES**

Delta 4WD (gear side)		450		<b>33.122</b>		•
Delta 4WD (instrument side)		637		<b>33.120</b>		•
Beta		1070		<b>33.104</b>		•
Trevi		1070		<b>33.104</b>		•
Prisma		990		<b>33.118</b>		•
Thema	=>86	1290		<b>33.114</b>		•
Thema	87=>	1250		<b>33.546</b>		•

**MERCEDES**

190 (4 speed)	84=>	1450	13M+22V1	<b>36.109</b>	2015400868	0,382
190 (5 speed)	84=>	1410	13M+22V1	<b>36.120</b>	2015401568	0,419
190 E 2,6		1530	13M2+22V1	<b>36.122</b>	2015401668	0,393
200	69=>	1160	13M+22V2	<b>36.101</b>	1155420207	0,290
200-200D-220-230 (5 speed)	75=>	1384	13M+22V1	<b>36.115</b>	1235248007	0,372
200	75=>	1333	13M+22V2	<b>36.103</b>	1235420307	0,356
230 T-240 TD-250 T-280 TE	75=>	1400	13M+22V2	<b>36.119</b>	1235421707	0,383
200	82=>	1440	13M+22V1	<b>36.105</b>	1235427707	0,403
200	86=>	1495	13M+22V1	<b>36.111</b>	1245400268	0,389
240 D	75=>	1227	13M+22V1	<b>36.107</b>	1145420707	0,318
230-280 CE (autotrans)		1474	13M+22V2	<b>36.118</b>	1235420607	0,378

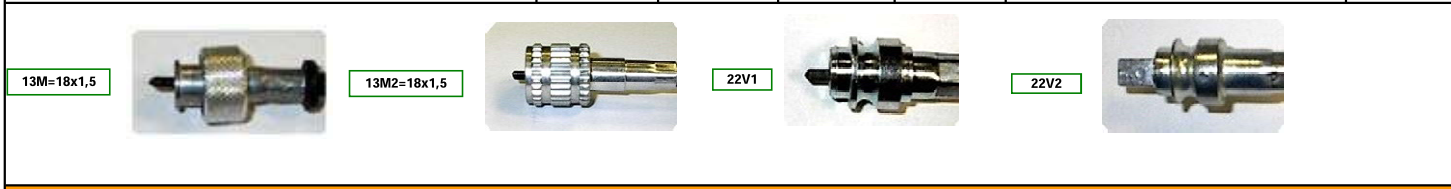

**MITSUBISHI**

L200 Pick-Up		1830	10J6+2B5	<b>47.000</b>	MB415430	0,340
--------------	--	------	----------	---------------	----------	-------

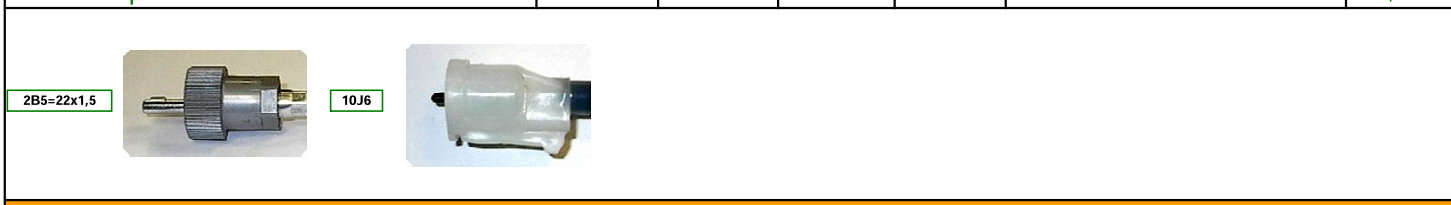





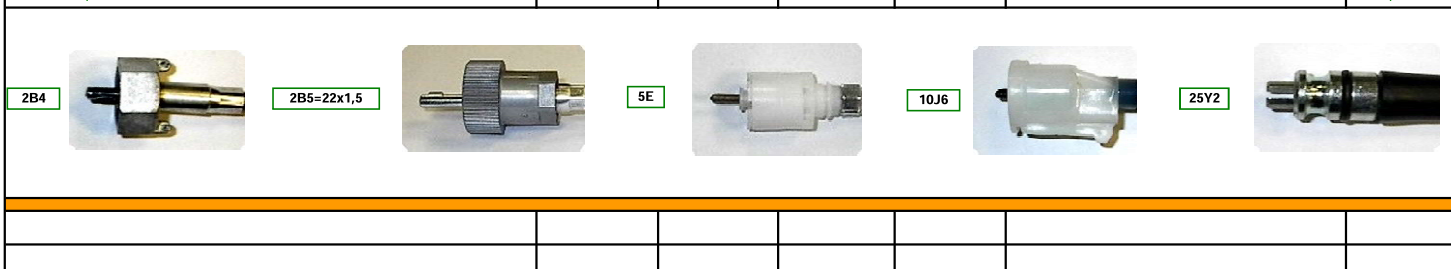

**NISSAN**

Micra all	93=>	869	2B5+10J6	<b>21.000</b>	2505054B65	0,178
Trade 2,0	93=>	3080	5E+2B4	<b>21.014</b>	13605121	•
Trade 2,8	93=>	2930	5E+25Y2	<b>21.015</b>	13605160	0,624









**TRASMISSIONI FLESSIBILI CONTACHILOMETRI - SPEEDOMETER CABLES - CABLES DE COMPTEUR  
TACHOMETERWELLEN - FLEXIBLES VELOCIMETROS - CABOS C/KILOMETROS  
LINKI SZYBKOSCMIERZA - LANKA RYCHLOMĚRU - ТРОСЫ СПИДОМЕТРА**

					OEM REF.	
<b>OPEL</b>						
Corsa	82=>	800	4D1+19S	<b>23.129</b>	1268028	0,204
Corsa (strumento suppl.)		835	4D1+19S	<b>23.127</b>	1268030	0,211
Corsa A	85=>93	750	4D1+13M	<b>23.241</b>	1268041	0,156
Corsa B 1,2-1,4-1,6-D-TD	93=>	860	4D1+19S	<b>23.125</b>	1268091-1268324-1268326	0,212
Corsa B 1,2-1,4-1,6 BZ	94=>	1095	4D1+13M	<b>23.150</b>	1268415	0,219
Kadett B		1442	13M+13M	<b>23.101</b>	1268075	0,337
Kadett C	75=>	1285	20T+13M	<b>23.103</b>	1268152	0,269
Kadett E		900	4D1+13M	<b>23.131</b>	1268214	0,184
Kadett D	80=>	860	4D1+13M	<b>23.105</b>	1268213	0,183
Kadett Diesel		860	4D1+19S	<b>23.125</b>	1268236	0,212
Kadett E		920	4D1+13M	<b>23.117</b>	1268055	0,188
Kadett E Autotrans		1000	4D1+13M	<b>23.240</b>	1268061	0,206
Astra 1.4-1.6-1,7 D	89=>	854	4D1+13M	<b>23.147</b>	1268282	0,186
Astra 1,8-2,0	89=>	855	4D1+19S	<b>23.149</b>	1268284	0,231
Astra	92=>95	855	4D1+19S	<b>23.149</b>	1268332	0,231
Astra 1,4-1,6-1,8 (no ABS)	96=>	855	4D1+19S	<b>23.149</b>	1268351	0,231
Astra 1,4-1,6-1,8 Abs	96=>	1240	4D1+13M	<b>23.109</b>	1268350	0,280
Astra 1,4-1,6-TD	=>96	860	4D1+13M	<b>23.105</b>	1268306-1268335-1268213	0,183
Ascona	70=>	1185	13M+13M	<b>23.107</b>	1268100	0,268
Ascona B	76=>	1240	4D1+13M	<b>23.109</b>	1268182	0,280
Ascona C 1,3		900	4D1+13M	<b>23.131</b>	1268214	0,184
Ascona C 1,3		860	4D1+13M	<b>23.105</b>	1268213	0,183
Ascona C 1,6-1,8	81=>	900	4D1+19S	<b>23.123</b>	1268238	0,223
Ascona C D		860	4D1+19S	<b>23.125</b>	1268236	0,212
Manta	70=>	1185	13M+13M	<b>23.107</b>	1268100	0,268
Manta	76=>	1240	4D1+13M	<b>23.109</b>	1268182	0,280
Vectra 1.4-1.6-1,7 D	89=>	854	4D1+13M	<b>23.147</b>	1268282	0,186
Vectra 1,8-2,0	89=>	855	4D1+19S	<b>23.149</b>	1268284	0,231
Vectra	92=>95	855	4D1+19S	<b>23.149</b>	1268332	0,231
Vectra 1,4-1,6-TD	=>96	860	4D1+13M	<b>23.105</b>	1268306-1268335-1268213	0,183
Calibra	92=>95	855	4D1+19S	<b>23.149</b>	1268332	0,231
Rekord B (auto trans)	75=>	1375	13M+13M	<b>23.202</b>	1268169	0,28
Rekord C	66=>	1553	13M+13M	<b>23.111</b>	1268071	0,342
Rekord D	78=>	1195	20T+13M	<b>23.137</b>	1268167	0,239
Rekord E	78=>	1308	4D1+13M	<b>23.115</b>	1268208-1268187	0,288
Rekord E D (4 speed)	81=>82	1430	4D1+13M	<b>23.113</b>	1268206	0,308
Rekord E D (5 speed)		1345	4D1+13M	<b>23.121</b>	1268038	0,297
Omega		1260	4D1+1A	<b>23.135</b>	1268267-90336830	0,248
Omega		1540	4D1+1A	<b>23.136</b>	1268340-90510876	0,312



**TRASMISSIONI FLESSIBILI CONTACHILOMETRI - SPEEDOMETER CABLES - CABLES DE COMPTEUR  
TACHOMETERWELLEN - FLEXIBLES VELOCIMETROS - CABOS C/KILOMETROS  
LINKI SZYBKOŚCIOMIERZA - LANKA RYCHŁOMĚRU - ТРОСЫ СПИДОМЕТРА**

					OEM REF.	
<b>PEUGEOT</b>						
104	=>80	920	7G+12L	<b>24.101</b>	612245	0,200
104	80=>07/85	910 R	3A - 1E	<b>24.135</b>	612296-612324	0,200
104	07/85=>	880	7G+11K	<b>24.105</b>	612373	0,215
106 all	90=>	900	10J+25Y	<b>24.148</b>	6123C4	0,216
204	02/76=>	1175	7G+12L	<b>24.137</b>	612243-612261	0,371
205 all BZ	=>87	938	10J1+12L1	<b>24.153</b>	612387	0,245
205 all BZ	=>85	895	10J1+12L	<b>24.139</b>	612334	0,238
205 all BZ	=>87	938	10J1+12L1	<b>24.153</b>	612387	0,245
205 all BZ	=>85	895	10J1+12L	<b>24.139</b>	612334	0,238
205 all BZ	88=>	897	10J+12L1	<b>24.151</b>	612392	0,206
205 D	88=>	900	10J+25Y	<b>24.148</b>	612379	0,216
205 D	=>87	985	10J1+25Y	<b>24.141</b>	612364	0,239
205 all	90=>	900	10J+25Y	<b>24.148</b>	6123C4	0,216
304	02/76=>	1175	7G+12L	<b>24.137</b>	612243-612261	0,371
305 all	77=>	800	10J+12L	<b>24.115</b>	612283	0,192
305 D	83=>	990	10J+25Y	<b>24.143</b>	612322-9252674680	0,225
305 D	84=>	1015	10J+25Y	<b>24.159</b>	612374	0,233
306 all	93=>	915	10J5+25Y	<b>24.164</b>	6123H3-9613334080	0,245
309 all	85=>	900	10J+25Y	<b>24.148</b>	612379-6123C4	0,216
404 all	=>69	1620	7G+11K	<b>24.119</b>	612224-612217	0,291
404 all	69=>	1720	7G+11K	<b>24.121</b>	612229	•
404 all	76=>	1720	7G+12L	<b>24.123</b>	612252	0,369
405 all BZ		900	10J+25Y	<b>24.148</b>	612379-6123C4	0,216
405 D		980	10J+25Y	<b>24.157</b>	612395	0,214
405 all	93=>	940	10J5+25Y	<b>24.158</b>	6123F2-6123F3-6123H7-6123H8	0,263
405 T16	93=>	940	10J5+25Y	<b>24.158</b>	6123F2/H8	
504 (II° S.)		2034	2F - 1C	<b>24.147</b>	612263	•
504	=>76	1810	7G+11K	<b>24.125</b>	612238	0,403
504	77=>	1810	7G+12L	<b>24.129</b>	612270	0,364
504	79=>	1810	10J+12L	<b>24.127</b>	612288	0,383
504	83=>	1810	10J+12L1	<b>24.173</b>	612350	0,367
504 L-GR-SR	10/83=>	2000	10J+12L1	<b>24.174</b>	612390	0,395
505 (4 speed)	=>83	1620	10J1+12L	<b>24.131</b>	612290-612316	0,376
505 (5 speed)	=>83	1940	10J1+12L	<b>24.169</b>	612314	0,415
505 (4 speed)	84=>	1620	10J1+12L1	<b>24.163</b>	612342-612348	0,342
505 (5 speed)	84=>	1940	10J1+12L1	<b>24.171</b>	612346	0,420
605 all		970	10J5+25Y	<b>24.168</b>	6123F4	0,259

**TRASMISSIONI FLESSIBILI CONTACHILOMETRI - SPEEDOMETER CABLES - CABLES DE COMPTEUR  
TACHOMETERWELLEN - FLEXIBLES VELOCIMETROS - CABOS C/KILOMETROS  
LINKI SZYBKOSCMIERZA - LANKA RYCHLOMĚRU - ТРОСЫ СПИДОМЕТРА**



OEM REF.



**PEUGEOT - Commercial Vehicle**

J5 all	81=>	1231	5E+17Q	<b>38.281</b>	612309	0,277
J5	91=>93	990	5E+17Q1	<b>24.282</b>	6123C7	0,218
J5	07/93=>	1400	5E+15O	<b>24.283</b>	6123G4	0,341
J7-J9	76=>83	1740	7G+11K	<b>24.121</b>	612229	•
J7-J9	83=>	2350	10J+17Q	<b>24.161</b>	612341	0,466
J7-J9	07/86=>	2500	10J+12L1	<b>24.195</b>	612386	•
Boxer D-TD		1510	5E+15O	<b>34.159</b>	6123G6-6123K6	0,370
Boxer		1512	5E+25Y1	<b>34.128</b>	6123G8-6123K2	0,342

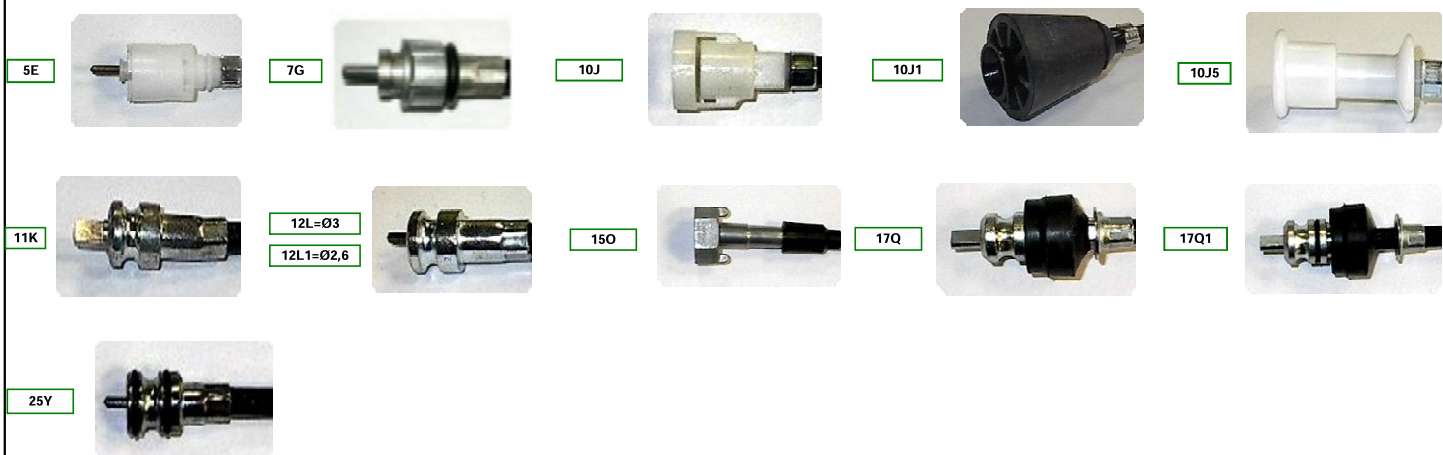

**POLSKI**









126-126 Bis		2515	1A+13M	<b>38.101</b>	7536340	0,510
125 P		1090	1A+13M	<b>38.197</b>	4125295	0,246



**RENAULT**

R4	=>73	1280	7G+14N	<b>25.105</b>	7700508327-7700557141	0,288
R4	73=>	1500	7G+14N	<b>25.107</b>	7700634251	0,339
R4 GTL	=>82	1670	7G+14N2	<b>25.103</b>	7700537580-7701348393	0,360
R4 L-TL	82=>	1550	10J+14N2	<b>25.171</b>	7701349473	0,337
R4 GTL	82=>	1770	10J+14N2	<b>25.114</b>	7701349474	0,376
R5 L	74=>	1420	7G+14N1	<b>25.109</b>	7701348388	0,308
R5 TL-TS	76=>	1570	7G+14N1	<b>25.129</b>	7701348391-7701348392	0,342
R5 all	79=>	1550	10J+14N1	<b>25.115</b>	7701348748-7701349973	0,334
R5 TL	82=>	1770	10J+14N2	<b>25.114</b>	7701349474	0,376
R5 all	=>84	1545	10J+14N2	<b>25.112</b>	7700768734	0,371

**TRASMISSIONI FLESSIBILI CONTACHILOMETRI - SPEEDOMETER CABLES - CABLES DE COMPTEUR  
TACHOMETERWELLEN - FLEXIBLES VELOCIMETROS - CABOS C/KILOMETROS  
LINKI SZYBKOSCIOMIERZA - LANKA RYCHLOMĚRU - ТРОСЫ СПИДОМЕТРА**

					OEM REF.	
<b>RENAULT</b>						
Supercinque	88=>	950	10J+14N2	<b>25.161</b>	7701349842-7701348372 7701349272-7701349291	0,270
Clio	90=>	890	10J+14N2	<b>25.116</b>	7700796635	0,219
R6	=>73	1280	7G+14N	<b>25.105</b>	7700508327-7700557141	0,288
R6	73=>	1500	7G+14N	<b>25.107</b>	7700566111	0,339
R9		1672	10J+14N2	<b>25.163</b>	7701349372	0,349
R9-R11	88=>	950	10J+14N2	<b>25.161</b>	7701349842-7701349272 7701349291-7701348372	0,270
R12 TL-TS	71=>	1570	7G+14N1	<b>25.129</b>	7700538906-7701348392	0,342
R12 TL-TS	75=>	1540	10J+14N1	<b>25.133</b>	7701348732-7700615864	0,329
R12 Dacia		1680	7G+14N	<b>25.250</b>	6000036898	•
R14 (instrument side)		650	10J+8H	<b>25.135</b>	7701349050-7700640234	0,138
R14 (gear side)		290	7G+12L	<b>25.137</b>	7701348397	0,076
R15 TS	71=>	1570	7G+14N1	<b>25.129</b>	7700538906-7701348392	0,342
R15 TL-TS	75=>	1540	10J+14N1	<b>25.133</b>	7701348395-7701348732 7700615864	0,329
R16 L-TL		1470	7G+14N	<b>25.141</b>	7700511877	0,324
R16 TS-TX		1580	7G+14N	<b>25.143</b>	7700528761	0,354
R17 TL-TS	75=>	1540	10J+14N1	<b>25.133</b>	7701348395-7701348732 7700615864	0,329
R18 (4 speed)		1450	10J+14N1	<b>25.145</b>	7701348245	0,313
R18 (5 speed)/Fuego		1400	10J+14N2	<b>25.179</b>	7701349411	0,313
R19 all	88=>	1190	10J+14N2	<b>25.160</b>	7701349863	0,316
R20 BZ	75=>	1540	10J+14N1	<b>25.133</b>	7701348732	0,329
R20 D		1240	10J+14N2	<b>25.201</b>	7700676123	0,247
R21 D		1410	10J+14N2	<b>25.139</b>	7700765535	0,435
R21 BZ/Nevada		1100	10J+14N2	<b>25.125</b>	7700765534	0,282
R30 all		1090	7G+14N1	<b>25.140</b>	7700572884	0,368
Laguna D	94=>		7G+14N	<b>25.143</b>	7700841913-7704103400	0,313
Espace TSE		1400	10J+14N2	<b>25.179</b>	7701349411-7701348778	0,313
Espace		1510	10J+14N2	<b>25.153</b>	6025002131	0,345
 						
<b>RENAULT - Commercial Vehicle</b>						
R4-F4 Cargo (1120/3/36)	=>73	1280	7G+14N	<b>25.105</b>	7700508327-7700557141	0,288
R4-Cargo (1120/3/6)	73=>	1500	7G+14N	<b>25.107</b>	7700634251	0,339

**TRASMISSIONI FLESSIBILI CONTACHILOMETRI - SPEEDOMETER CABLES - CABLES DE COMPTEUR  
TACHOMETERWELLEN - FLEXIBLES VELOCIMETROS - CABOS C/KILOMETROS  
LINKI SZYBKOŚCIOMIERZA - LANKA RYCHŁOMĚRU - ТРОСЫ СПИДОМЕТРА**



**RENAULT - Commercial Vehicle**

Express	=>09/94	950 R	10J+14N2	<b>25.161</b>	7701349842-7700704381	0,270
Express all	09/94=>	950 R	10J+14N2	<b>25.161</b>	7700272069	0,270
Estafette		2220	7G+12L	<b>25.260</b>	7700513302	0,461
Trafic T.AV.	81=>	1500	10J+14N2	<b>25.149</b>	7700665336	0,341
Trafic T.AV. 1,7 cc	81=>	1220	10J+14N2	<b>25.102</b>	7700713806	0,271
Trafic P.AR.	81=>	1840	10J+14N2	<b>25.104</b>	7700671927	0,410
Master T.AV. (4 speed)	81=>	1150	10J+15O	<b>25.106</b>	5000409595-5000409598	0,276
Master T.AV. (5 speed)	81=>	1300	10J+15O	<b>25.151</b>	5000409842-5000409849	0,311
Master T.AV. D	89=>	1550	10J+15O	<b>25.108</b>	7700748162	0,384
Master P.AR.	02/89=>	2440	10J+15O	<b>25.110</b>	5000409741	0,526
Master P.AR.	03/89=>	2900	10J+15O	<b>25.202</b>	7700743361	0,668

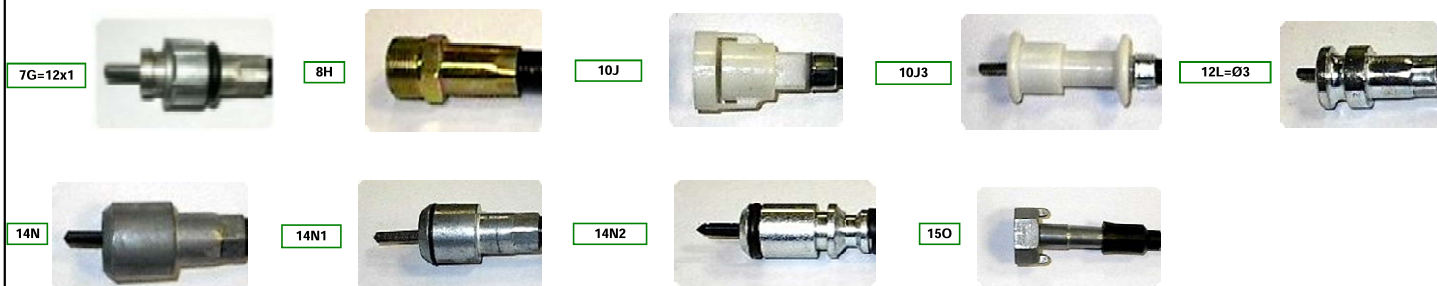

**ROVER**

Mini Morris		641	2B1+7G	<b>29.109</b>	383362103	0,140
Mini	85=>	610	2B1+7G	<b>29.125</b>	GSD101	0,138
Mini Special	85=>	755	18R1+2B6	<b>29.127</b>	ADU5915	0,163
Mini Cooper		681	1A+2B6	<b>29.103</b>	05096	0,149
Metro	=>85	812	10J+2B3	<b>29.107</b>	GSD373	0,174
Metro	85=>	912	10J+2B3	<b>29.115</b>	GSD406	0,197
Land Rover D		2401	18R1+3C1	<b>29.113</b>	623055	0,497



**SEAT**

Marbella		900	5E+13M	<b>38.105</b>	X044138590-SE141130327A	0,216
Panda		900	5E+13M	<b>38.105</b>	X044138590-SE141130327A	0,216
127 Fura		752	5E+13M	<b>38.173</b>	X039602370	0,176

**TRASMISSIONI FLESSIBILI CONTACHILOMETRI - SPEEDOMETER CABLES - CABLES DE COMPTEUR  
TACHOMETERWELLEN - FLEXIBLES VELOCIMETROS - CABOS C/KILOMETROS  
LINKI SZYBKOŚCIOMIERZA - LANKA RYCHŁOMĚRU - ТРОСЫ СПИДОМЕТРА**



<b>SEAT</b>						
Ibiza	86=>	1270	5E+13M	<b>38.113</b>	X03963310-SE022130327A	0,279
Malaga	86=>	1270	5E+13M	<b>38.113</b>	X03963310-SE022130327A	0,279
Ronda	86=>	1270	5E+13M	<b>38.113</b>	X03963310-SE022130327A	0,279
Toledo BZ ABS	91=>	1115	23W3+23W2	<b>48.573</b>	1L0957783D	0,281
Toledo BZ/D	91=>	975	23W3+23W2	<b>48.574</b>	1L0957783-A	0,244



<b>SEAT - Commercial Vehicle</b>						
Terra		900	5E+13M	<b>38.105</b>	X044138590-SE141130327A	0,216
Terra		1150	10J+13M	<b>48.570</b>	X039649360	0,251
Terra D		1230	10J+13M	<b>48.571</b>	X039607660	0,252



<b>SKODA</b>						
105-120		2880	13M+11K	<b>26.101</b>	113980090	0,506
Favorit		960	13M+13M	<b>26.103</b>	115980090	0,161
Felicia		955	13M+13M	<b>26.104</b>	004410165-640957785 6U0957785	0,232



<b>SUZUKI</b>						
Sprint	87=>	1035	10J6+25Y2	<b>42.002</b>	3491082010	0,209
Sprint	90=>	974	10J6+14N3	<b>42.003</b>	3491061B00	•
Swift	90=>	974	10J6+14N3	<b>42.003</b>	3491061B00	•
Santana SJ410-SJ413		2250	1A+25Y2	<b>42.000</b>	3491080030	0,455
Santana SJ410-SJ413 (USA model)		2250	10J6+25Y2	<b>42.001</b>	3491080031-3491080C30 3491080C31	0,412



<b>TALBOT</b>						
1100 S	73=>79	1040	10J+12L1	<b>28.115</b>	15819100-44418Z	0,228

**TRASMISSIONI FLESSIBILI CONTACHILOMETRI - SPEEDOMETER CABLES - CABLES DE COMPTEUR  
TACHOMETERWELLEN - FLEXIBLES VELOCIMETROS - CABOS C/KILOMETROS  
LINKI SZYBKOŚCIOMIERZA - LANKA RYCHŁOMĚRU - ТРОСЫ СПИДОМЕТРА**



**TALBOT**

Horizon	=>79	920	10J2+12L1	<b>28.121</b>	522342900	0,211
Horizon	80=>	920	10J2+25Y	<b>28.123</b>	522345800	0,200
Samba	82=>	910	10J+12L	<b>28.133</b>	9250221880	0,202
1307-1308	=>78	940	10J+12L	<b>28.125</b>	134674000	0,203
1510/Solara	78=>	940	10J+25Y	<b>28.131</b>	570444000	0,189

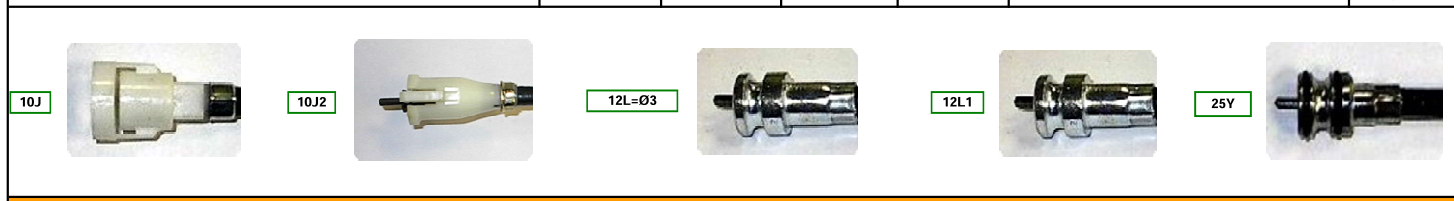

**TOYOTA**

Celica w/AT	76=>80	1797	2B4+10J6	<b>44.004</b>	8371019436	0,316
Celica w/AT	82=>85	1996	2B4+10J6	<b>44.003</b>	8371014350	0,179

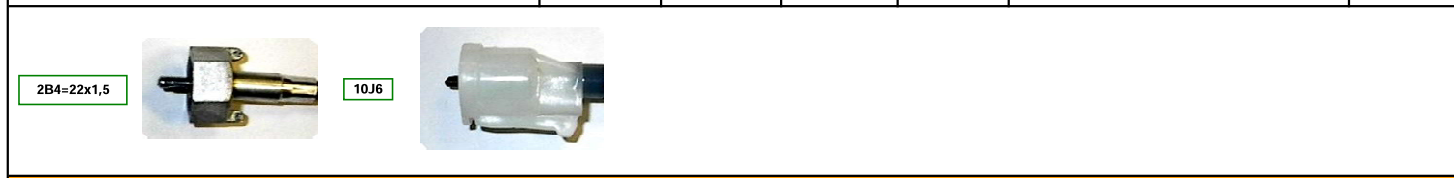

**VOLKSWAGEN**

Polo all	=>84	1030	13M+13M	<b>39.100</b>	861957801	0,221
Polo all (with servo brake)	85=>	1230	23W+13M	<b>39.145</b>	861957801A	0,260
Polo all (without servo brake)	85=>	1100	23W+13M	<b>39.102</b>	861957801B	0,240
1200 Beetle	57=>	1240	13M+23W1	<b>39.131</b>	111957801K-111957801J	0,212
1303	70=>	1408	13M+23W1	<b>39.105</b>	113957801A-113957801B	0,206
Golf all	=>78	1010	13M+13M	<b>39.133</b>	171957803B	0,221
Golf all	79=>81	998	13M+23W2	<b>39.135</b>	171957803C	0,234
Golf/Jetta 1,1-1,3	81>=	1020	13M+23W	<b>39.123</b>	171957803G	0,228
Golf/Jetta 1,6-1,8	81>=	998	23W+23W2	<b>39.125</b>	171957803H	0,229
Golf LS 1,5 (70 PS)		975	13M+23W2	<b>39.104</b>	171957803D	0,234
Golf/Jetta all	85=>	1120	23W+23W2	<b>39.117</b>	191957803D	0,269
Golf/Jetta Autotrans	85=>	1100	23W+13M	<b>39.610</b>	191957803B	0,215
Golf/Jetta	87=>	1060	23W+13M	<b>39.611</b>	191957803H	0,239
Scirocco all	=>78	1195	13M+13M	<b>39.115</b>	531957803B	0,237
Passat/Santana (4 cyl.)	81=>	1410	23W+19S	<b>39.137</b>	321957803AF	0,326
Passat 1,6-1,8-D	81=>	1290	23W+19S	<b>39.106</b>	321957803AA	0,311
Passat		1630	13M+19S	<b>39.103</b>	321957803AC	0,404
Passat	94=>	1010	23W3+19S	<b>39.612</b>	357957803A	0,290

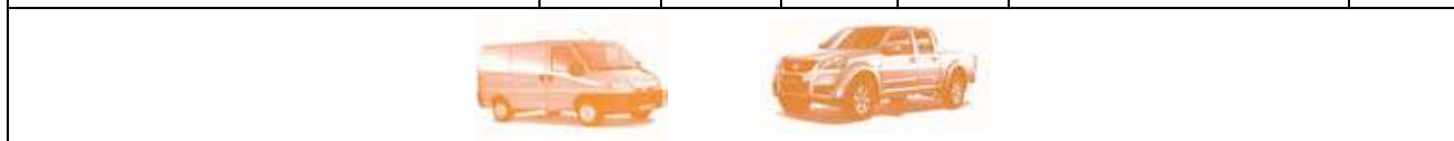

**VOLKSWAGEN - Commercial Vehicle**

Transporter	55=>	2060	13M+23W1	<b>39.119</b>	211957801E	0,361
Transporter	67=>	2420	13M+23W1	<b>39.121</b>	211957801F	0,422

**TRASMISSIONI FLESSIBILI CONTACHILOMETRI - SPEEDOMETER CABLES - CABLES DE COMPTEUR  
TACHOMETERWELLEN - FLEXIBLES VELOCIMETROS - CABOS C/KILOMETROS  
LINKI SZYBKÓCIOMIERZA - LANKA RYCHŁOMĚRU - ТРОСЫ СПИДОМЕТРА**

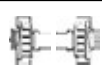

OEM REF.



**VOLKSWAGEN - Commercial Vehicle**

Transporter 1,6-2,0	=>81	2245	13M+23W1	<b>39.139</b>	251957803	0,394
Transporter 1,6-2,0/Bus	81=>	2235	23W+23W1	<b>39.141</b>	251957803A	0,426
Transporter all		1635	13M+23W1	<b>39.495</b>	224957809A	0,281



**VOLVO**

240		2005	20T+13M	<b>41.101</b>	12155461	0,474
142/164 (overdrive)	72=>	2000	20T+13M	<b>41.102</b>	1214055	0,534
142/164 (overdrive)	72=>	1735	20T+13M	<b>41.103</b>	1214307	0,457
340/360	84=>	1335	20T+22V3	<b>41.107</b>	3205601-3207948	0,266



**YUGO - ZASTAVA**

101 (128)		1082	1A+13M	<b>38.197</b>	1016494	0,246
-----------	--	------	--------	---------------	---------	-------









**automotive products**

**TRASMISSIONI CKM INTERNE  
REGOLABILI  
UNIVERSAL INNER SPEEDOMETER  
CABLES  
CABLES DE COMPUTER REGOLABLES  
FLEXIBLES VECOCIMETROS  
UNIVERSALES  
CABOS C/KILOMETROS UNIVERSAIS  
CIĘGNA LINEK SZYBKOCÍOMIERZA  
UNIVERZÁLNÍ VNITŘNÍ  
LANKA RYCHLOMĚRU  
УНИВЕРСАЛЬНЫЕ ТРОСЫ  
СПИДОМЕТРА БЕЗ ОБОЛОЧКИ**

**TRASMISSIONI CKM INTERNE REGOLABILI - UNIVERSAL INNER SPEEDOMETER CABLES  
 CABLES DE COMPUTER REGOLABLES FLEXIBLES VECOCIMETROS UNIVERSALES  
 CABOS C/KILOMETROS UNIVERSAIS CABOS C/KILOMETROS UNIVERSAIS CIĘGNA LINEK SZYBKÓŚCIOMIERZA  
 UNIVERZÁLNÍ VNITŘNÍ LANKA RYCHLOMĚRU УНИВЕРСАЛЬНЫЕ ТРОСЫ СПИДОМЕТРА БЕЗ ОБОЛОЧКИ**

				OEM REF.	
Inner speedo / CKM interno ø 3,2 mm		1000	<b>52.100</b>		•
Inner speedo / CKM interno ø 3,2 mm		1400	<b>52.101</b>		•
Inner speedo / CKM interno ø 3,2 mm		2200	<b>52.102</b>		•
Inner speedo / CKM interno ø 3,2 mm		2800	<b>52.103</b>		•
Inner speedo / CKM interno ø 3,2 mm		3600	<b>52.104</b>		•
Inner speedo / CKM interno ø 3,2 mm		4200	<b>52.105</b>		•
Inner speedo / CKM interno ø 3,2 mm		4800	<b>52.106</b>		•



### CONDIZIONI GENERALI DI VENDITA

**ORDINI** – Tutti gli ordini si intendono ricevuti "salvo approvazione"

**SPEDIZIONE** – La merce viaggia a rischio e pericolo del destinatario anche se venduta franco destino.

**CONSEGNA** – I ritardi o le mancate consegne dei materiali eventualmente non disponibili nei nostri magazzini, non daranno adito alla soluzione del contratto e non potranno costituire in nessun caso titolo di risarcimento di danni.

**PREZZI** – Sono validi quelli della data di consegna. I prezzi indicati si intendono per merce franco nostro magazzino.

**PAGAMENTO** – Il pagamento delle fatture deve essere effettuato alle condizioni e alle scadenze indicate in fattura.

**GARANZIE & RECLAMI** - Qualsiasi reclamo deve essere fatto entro 8 giorni dal ricevimento della merce. I nostri materiali sono garantiti. La garanzia si limita alla sostituzione gratuita dei pezzi che venissero da noi riconosciuti difettosi per cause dipendenti dai materiali o da imperfetta lavorazione. Decliniamo, pertanto, ogni responsabilità per qualunque conseguenza o danno derivante dalla merce fornita. Per ogni controversia è competente il Foro di Torino.



### GENERAL SALES CONDITIONS

**ORDERS** – Receipt of orders is acknowledged upon approval.

**SHIPMENT** – Goods are shipped at the customer's risk, even if sold free at destination.

**DELIVERY** – Late or no deliveries of goods not available on stock cannot give rise to contract or cancellation and in any case will not oblige to compensate for damage.

**PRICES** – The prices on the date of delivery are valid. The invoice prices are for goods delivered free our warehouse.

**PAYMENT** – Invoices must be paid at the conditions and the dates therein indicated.

**WARRANTY & CLAIMS** - Any claim must be made within 8 days from receipt of goods, which are guaranteed. The warranty covers free replacement of those pieces recognized to be defective due to poor quality of material or to bad working. Therefore we decline any responsibility for consequences or damages whatsoever caused by the supplied goods. For controversies apply to the Court of Justice in Turin.



### CONDITIONS GENERALES DE VENTE

**COMMANDES** – Toutes les commandes se reçoivent sauf approbation.

**EXPEDITION** – La marchandise est expédiée aux risques et périls du client, même si vendue franco destination.

**LIVRAISON** – Les livraisons retardées ou manquées de la marchandise pas disponible dans nos magasins ne donnent pas lieu à la solution du contrat et ne pourront jamais constituer titre de dédommagement.

**PRIX** – Les prix stipulés à la date de livraison sont applicables. Les prix indiqués sont pour livraison marchandise franco notre magasin.

**PAIEMENT** – Les factures doivent être payées selon les conditions et échéances mentionnées dans la facture même.

**GARANTIE & RECLAMATIONS** - Chaque réclamation doit être fait dans 8 jours dès réception de la marchandise, laquelle est garantie. La garantie est limitée au remplacement gratuit des pièces qui ont été trouvées défectueuses à cause du matériel ou de mauvais travail. Pourtant nous déclinons toute responsabilité pour chaque conséquence ou dommage dérivé de la marchandise fournie. Pour chaque controverse est compétent le Tribunal de Turin.



### ALLGEMEINE VERKAUFS UND LIEFERBEDINGUNGEN

**AUFTRÄGE** – Alle Bestellungen gelten erst nach Annahme.

**VERSAND** – Warentransport erfolgt zum Risiko und Gefahr des Empfängers, auch wenn frei Haus geliefert.

**LIEFERUNG** – Evtl. Lieferverzögerungen oder Nicht-Lieferung von in unseren Warenhäusern nicht verfügbaren Waren geben keinen Anspruch zur Vertragsauflösung und stellen in keinem Fall einen Anspruch zur Entschädigung dar.

**PREISE** – Die Berechnung erfolgt zu den am Versandtag gültigen Preisen. Die Preise verstehen sich für Warenlieferung ab Work.

**ZAHLUNGSWEISE** – Zahlung der Rechnungen ist zu den in den Rechnungen angegebenen Zahlungs-Bedingungen bzw. Termine zu erfolgen.

**GARANTIELIESTUNG/REKLAMATIONEN** - Evtl. Reklamationen sind binnen 8 Tagen nach Warenehalt anzugeben. Unsere Waren stehen unter Garantie, doch ist die Garantieleistung auf kostenlosem Ersatz von solchen Teilen beschränkt, die von uns als mangelhaft wegen Material-oder Fabrikationsfehler anerkannt sind. Bezüge bzw. Angabem zu den in diesem Katalog enthaltenen ursprünglichen Herstellerprodukten sind nur orientativ angegeben. Deshalb wird von uns jede Verantwortung auf jedwelchen entstehenden Folgen bzw. Schäden aus dor gelieferten Waren abgelehnt. Für evtl. Streitfragen ist das Gericht Torino zuständig.



### CONDICIONES GENERALES DE VENTA

**PEDIDOS** – Todos los pedidos se consideran recibidos "salvo aprobación"

**ENVIOS** – La mercancía viaja a riesgo y peligro del destinatario aunque se haya vendido con entrega en destinación.

**ENTREGAS** – Los retrasos o la falta de entrega de los materiales eventualmente no disponibles en nuestros almacenes, no darán lugar a la disolución del contrato y no podrán constituir en ningún caso título de indemnización de daños.

**PRECIOS** – Son válidos los de la fecha de la entrega. Los precios indicados se consideran tales para las mercancías entregadas en nuestro almacén.

**PAGOS** – El pago de las facturas debe efectuarse en las condiciones y en los plazos indicados en la factura.

**GARANTIAS Y RECLAMACIONES** – Cualquier tipo de reclamación se debe realizar dentro de los 8 días sucesivos a la recepción de la mercancía. Nuestros materiales están garantizados. La garantía se limita a la sustitución gratuita de las piezas que nosotros podamos reconocer como defectuosas por causas dependientes de los materiales o de la imperfecta elaboración. Declanimos, por lo tanto, toda responsabilidad por cualquier consecuencia o daño que derive de la mercancía suministrada. Para cualquier controversia será competente el Juzgado de Turin.

UPDATING

**CAVI FRIZIONE - CLUTCH CABLES - CABLES DE DEBRAYAGE  
KUPPLUNGSSEILE - CABLES EMBRAGUE - CABOS DE EMBRAIAGEM  
LINKI SPRZĘGŁA - SPOJKOVÁ LANKA - ТРОСЫ СЦЕПЛЕНИЯ**

				<b>OEM REF.</b>	
---	---	---	--	-----------------	---

**FIAT**

500 (II) 900 Twin Air 1.2 all	07=>	665/995	<b>01.1264</b>	55226950	0,401
500C 900 Twin Air 1.2 all	09=>	665/995	<b>01.1264</b>	55226950	0,401
Panda (II) 1.3 MJTD	10=>	620/990	<b>01.1263</b>	55230144	0,740
Panda (III) 900 1.2	12=>	665/995	<b>01.1264</b>	55226950	0,401



**FIAT - Commercial Vehicle**

Panda (II) Van 1.3 MJTD 2/4 seats all	10=>	620/990	<b>01.1263</b>	55230144	0,740
---------------------------------------	------	---------	----------------	----------	-------

**LANCIA**

Ypsilon (III) 1.2/1.2 GPL	11=>	665/995	<b>01.1264</b>	55226950	0,401
---------------------------	------	---------	----------------	----------	-------

**COMANDI FLESSIBILI FUNE FRENO A MANO - BRAKE CABLES - CABLES DE FREIN  
BREMSSSEILE - CABLES DE FRENO - CABOS DE TRAVAO  
LINKI HAMULCA - BRZDOVÁ LANKA - ТРОСЫ РУЧНОГО ТОПМОЗА**



OEM REF.



**COMANDI FLESSIBILI FUNE FRENO A MANO - BRAKE CABLES - CABLES DE FREIN  
BREMSSSEILE - CABLES DE FRENO - CABOS DE TRAVAO  
LINKI HAMULCA - BRZDOVÁ LANKA - ТРОСЫ РУЧНОГО ТОПМОЗА**

**FIAT**

500L all (drum brake) rear (LH/RH-SX/DX)	12=>	1450/1720	<b>07.2081</b>	51927743	0,578
500L all Living (drum brake) rear (LH/RH-SX/DX)	13=>	1450/1720	<b>07.2081</b>	51927743	0,578



**FIAT - Commercial Vehicle**

Ducato 250 front	09=>	705/975	<b>07.2103</b>	1361716080	•
Ducato 250 rear central	09=>	525/1460	<b>07.2104</b>	1362820080	•
Ducato 250 rear (RH-DX)	09=>	2545/2715	<b>07.2105</b>	1361721080	•
Ducato 250 rear (LH-SX)	09=>	2505/2680	<b>07.2106</b>	1361720080	•
Ducato 250 rear (RH-DX)	09=>	2470/2640	<b>07.2107</b>	1361718080	•
Ducato 250 rear (LH-SX)	09=>	2410/2580	<b>07.2108</b>	1361719080	•

**FORD**

Transit all (RHD) Bus mod. front	06=>	1430/1668	<b>07.2082</b>	5032098-7C1V2853CB	0,719
Transit all (RHD) exc. Bus mod. front	06=>	950/1198	<b>07.2083</b>	1464758-6C112853AE	0,485
Transit connect (I) 1.8 TDCi front	09=>	250	<b>07.2084</b>	4987625-9T162853AA	0,037
Transit RWD all -SWB central	00=>06	715	<b>07.2085</b>	4060870-YC152A793AE	0,152

**PEUGEOT**

508 rear (LH/RH-SX/DX)	10=>	1400/2235	<b>07.2086</b>	474681-9899992480	0,668
------------------------	------	-----------	----------------	-------------------	-------

**RENAULT**

Captur 0,9-1.2Tce-1.5 dCi rear (RH-DX)	13=>	1420/1640	<b>07.2087</b>	365308900R	0,505
Captur 0,9-1.2Tce-1.5 dCi rear (LH-SX)	13=>	1300/1520	<b>07.2088</b>	365315806R	0,458
Clio (IV) 1.6 RS200 EDC rear (RH-DX)	12=>	1540/1650	<b>07.2089</b>	365318024R	0,687
Clio (IV) 1.6 RS200 EDC rear (LH-SX)	12=>	1385/1495	<b>07.2090</b>	365307515R	0,611
Clio (IV) 0,9 Tce-1.2-1.2GPL-Tce wheel 15-16 rear (RH-DX)	10/12=>	1430/1610	<b>07.2091</b>	365302756R	0,503
Clio (IV) 0,9 Tce-1.2-1.2GPL-Tce wheel 15-16 rear (LH-SX)	10/12=>	1315/1485	<b>07.2092</b>	365311282R	0,457
Clio (IV) 0,9-1.2-1.2Tce-1.5 Dci (drum brake) wheel 17 rear (RH-DX)	10/12=>	1404/1623	<b>07.2093</b>	365304960R	0,504
Clio SW all (drum brake) rear (RH-DX)	10/12=>	1404/1623	<b>07.2093</b>	365304960R	0,504
Clio (IV) 0,9-1.2-1.2Tce-1.5 Dci (drum brake) wheel 17 rear (LH-SX)	10/12=>	1404/1623	<b>07.2094</b>	365317404R	0,454
Clio SW all (drum brake) rear (LH-SX)	10/12=>	1404/1623	<b>07.2094</b>	365317404R	0,454

**SUZUKI**

Gran Vitara (II) 1.6 4x4 (3 doors) rear (RH-DX)	05=>	1350/1620	<b>07.2095</b>	5440164J00	0,653
Gran Vitara (II) 1.6 4x4 (3 doors) rear (LH-SX)	05=>	1350/1620	<b>07.2096</b>	5440264J00	0,656
Gran Vitara all (5 doors) rear (RH-DX)	06=>	1540/1810	<b>07.2097</b>	5440165J00	0,715
Gran Vitara all (5 doors) rear (LH-SX)	06=>	1540/1810	<b>07.2098</b>	5440265J00	0,714

**CAVI FRIZIONE - CLUTCH CABLES - CABLES DE DEBRAYAGE  
KUPPLUNGSSEILE - CABLES EMBRAGUE - CABOS DE EMBRAIAGEM  
LINKI SPRZĘGŁA - SPOJKOVÁ LANKA - ТРОСЫ СЦЕПЛЕНИЯ**

				<b>OEM REF.</b>	
--	---	---	--	-----------------	---

**PEUGEOT**

206 all 1,9D (ch. 9583-) (manual adjust)	02=>	600/815	<b>01.1262</b>	2150EG-9686559380	0,274
--	------	---------	----------------	-------------------	-------

**RENAULT**

Laguna 1,9 Dci Dti 98cv (manual adjust)	91=>96	1132/1318	<b>01.1257</b>	7700421415	0,889
Laguna 1,9 Dti 98cv (manual adjust)	91=>96	1132/1318	<b>01.1257</b>	7700421415	0,889
Laguna 2,0 114cv (manual adjust)	98=>	870/1196	<b>01.1258</b>	7700431360	0,647
Laguna 2,0 139cv <b>a/a</b>	94=>	775/1095	<b>01.1259</b>	7700840097-7700428748	0,954
Laguna 3,0 167cv <b>a/a</b>	94=>	775/1095	<b>01.1259</b>	7700840097-7700428748	0,954
Espace III 1,9 Dti (manual adjust)	00=>01	860/1075	<b>01.1260</b>	6025312553	0,937

**SUZUKI**

Vitara 1,9D-1,9DT (4x4)	95=>98	1145/1405	<b>01.1261</b>	2003000000000-2371057B01000 2371057B20000-2371085C	0,499
-------------------------	--------	-----------	----------------	---	-------

**COMANDI FLESSIBILI FUNE FRENO A MANO - BRAKE CABLES - CABLES DE FREIN  
BREMSSSEILE - CABLES DE FRENO - CABOS DE TRAVAO  
LINKI HAMULCA - BRZDOVÁ LANKA - ТРОСЫ РУЧНОГО ТОРМОЗА**



OEM REF.



**COMANDI FLESSIBILI FUNE FRENO A MANO - BRAKE CABLES - CABLES DE FREIN  
BREMSSSEILE - CABLES DE FRENO - CABOS DE TRAVAO  
LINKI HAMULCA - BRZDOVÁ LANKA - ТРОСЫ РУЧНОГО ТОРМОЗА**

**AUDI**

80-90 Quattro (LH-SX)	83=>91	530/1150	<b>07.2077</b>	857609721D	•
80-90 Quattro (RH-DX)	83=>91	500/1120	<b>07.2048</b>	857609721E	•
RS4 4.2 Quattro (LH/RH-SX/DX)	05=>	1615/1780	<b>07.2049</b>	8E0609721BB	•
RS4 Avant 2.7 Bi Turbo Quattro (RH-DX)	99=>01	1680/1850	<b>07.2050</b>	8D0609722F	•
RS6 4.2 Quattro (LH/RH-SX/DX)	02=>05	1780/1955	<b>07.2051</b>	4B0609721AA	•

**CHEVROLET-DAEWOO**

Lacetti/Nubira all (RH-DX)	05=>	-	<b>07.2056</b>	96418136-96435119-96549802 96808380	0,863
Lacetti/Nubira all (LH-SX)	05=>	-	<b>07.2057</b>	96418134-96435117-96549800 96808379	0,860

**CITROEN**

DS5 2.0 Hdi Hybrid 4 (LH/RH-SX/DX)	11=>	-	<b>07.2055</b>	9801566780	0,281
C4 Air Cross 1,6-1,8 Hdi (4x4) (-ch. 13114) (RH-DX)	12=>	1418/1632	<b>07.2054</b>	1606294080	0,667
C-Crosser 4x4 mod. (LH-SX)	07=>	1425/1627	<b>07.2052</b>	474632-4820A103	0,734
C-Crosser 4x4 mod. (RH-DX)	07=>	1435/1645	<b>07.2053</b>	474633-4820A104	0,724

**FIAT**

Panda III 4x4 mod. all (LH-SX)	12=>	1337/1550	<b>07.2058</b>	51900394	0,523
Panda III 4x4 mod. all (RH-DX)	12=>	1337/1550	<b>07.2059</b>	51900392	0,521



**FIAT - Commercial Vehicle**

Daily all (LH/RH-SX/DX)	94=>00	980+980/ 2765	<b>07.2060</b>	99443476	0,734
-------------------------	--------	------------------	----------------	----------	-------

**FORD**

Fiesta VI (disc brake) (LH/RH-SX/DX)	12=>	1410/1590+ 1440/1625	<b>07.2061</b>	1818953-1838140	1,227
--------------------------------------	------	-------------------------	----------------	-----------------	-------

**HYUNDAI**

i10 all (disc brake) (RH-DX)	08=>	1117/1263	<b>07.2062</b>	597700X300	0,571
i10 all (disc brake) (LH-SX)	08=>	1110/1525	<b>07.2063</b>	597600X300	•
i30 I 1,4-1,6-2,0 (RH-DX)	07=>10	1500/1675	<b>07.2064</b>	597702H300	0,782
i30 I 1,4-1,6-2,0 (LH-SX)	07=>10	1500/1675	<b>07.2065</b>	597602H300	0,787

**M.C.C.**

Fortwo 2 pcs. (LH/RH-SX/DX)	07=>	855/1030+ 855/1030	<b>07.2066</b>	4514200385-4514200485	0,310
-----------------------------	------	-----------------------	----------------	-----------------------	-------

**COMANDI FLESSIBILI FUNE FRENO A MANO - BRAKE CABLES - CABLES DE FREIN  
BREMSSEILE - CABLES DE FRENO - CABOS DE TRAVAO  
LINKI HAMULCA - BRZDOVÁ LANKA - ТРОСЫ РУЧНОГО ТОРМОЗА**



OEM REF.



**MITSUBISHI**

Outlander II 4x4 mod. (LH-SX)	06=>	1425/1627	<b>07.2052</b>	474632-4820A103	0,734
Outlander II 4x4 mod. (RH-DX)	06=>	1435/1645	<b>07.2053</b>	474633-4820A104	0,724
Outlander II 2,2 DiD 4WD 2,4 Mivec 4x4 (RH-DX)	10=>	1418/1632	<b>07.2054</b>	4820A038	0,667
ASX 1,8 DiD 4WD (RH-DX)	10=>	1418/1632	<b>07.2054</b>	4820A038	0,667
L200 III 2,5 DiD Pick-Up (front-avt)	09=>	235	<b>07.2067</b>	MN102418	0,105

**PEUGEOT**

4007 4x4 mod. (LH-SX)	07=>	1425/1627	<b>07.2052</b>	474632-4820A103	0,734
4007 4x4 mod. (RH-DX)	07=>	1435/1645	<b>07.2053</b>	474633-4820A104	0,724
4008 1,6-1,8 Hdi 4x4 (-ch. 13114) (RH-DX)	12=>	1418/1632	<b>07.2054</b>	1606294080	0,667

**TOYOTA**

Yaris IV all (disc brake) (RH-DX)	11=>	1520/1700	<b>07.2068</b>	464200D210	0,741
Yaris IV all (disc brake) (LH-SX)	11=>	1595/1775	<b>07.2069</b>	464300D210	0,790
Yaris IV all (drum brake) (RH-DX)	11=>	1445/1690	<b>07.2070</b>	464200D200	0,707
Yaris IV all (drum brake) (LH-SX)	11=>	1370/1615	<b>07.2071</b>	464300D200	0,716
Auris II all (front-avt)	12=>	305	<b>07.2072</b>	4641002140	0,031
Corolla Sedan 1,3 16v-1,4/1,6 VVT-i 16v (LH-SX)	06=>	1735/1890	<b>07.2073</b>	4643012610	0,770
Corolla Sedan 1,3 16v-1,4/1,6 VVT-i 16v (RH-DX)	06=>	1765/1915	<b>07.2074</b>	4642012720	0,752
Corolla Sedan 1,4-2,0D-4D 16v (LH-SX)	06=>07	1740/1895	<b>07.2075</b>	4643012620	•
Corolla Sedan 1,4-2,0D-4D 16v (RH-DX)	06=>07	1765/1920	<b>07.2076</b>	4642012730	•
Corolla Sedan 1,4-2,0D-4D 16v (LH-SX)	07=>	1735/1890	<b>07.2073</b>	4643012610	0,770
Corolla Sedan 1,4-2,0D-4D 16v (RH-DX)	07=>	1765/1915	<b>07.2074</b>	4642012720	0,752

## Brake Cables - Cables de Frein

PIMAX REF.	OEM	APPLICATION		YEAR	↔
<b>Mini - BMW</b>					
<b>07.2216</b>	34406852190	MINI Cabrio «F57» (t.t.) MINI Cooper «F55», «F56» (t.t.) MINI One «F55», «F56» (t.t.)	rear RH	15- 14- 14-	770/500
<b>07.2217</b>	34406852187	MINI Cooper «F55» 1.5, 2.0 (t.t.) MINI One «F55» 1.2, 1.5 (t.t.)	front	13- 14-	1195/745
<b>07.2218</b>	34406852186	MINI Cooper «F56» 1.5, 2.0 (t.t.) MINI One «F56» 1.2, 1.5 (t.t.)	front	01-08	1120/665
<b>07.2219</b>	34406852189	MINI Cabrio «F57» (t.t.) MINI Cooper «F55», «F56» (t.t.) MINI One «F55», «F56» (t.t.)	rear LH	15- 14- 14-	847/495
<b>Chevrolet</b>					
<b>07.2220</b>	13304906	CRUZE (t.t.) small mod. (drum brake)	rear LH-RH	11-	205
<b>07.2221</b>	13352978	CRUZE 2.0 CDi (t.t.) (drum brake)	rear LH-RH	11-	1470/1355
<b>Chrysler</b>					
<b>07.2222</b>	4721312AC- 4721312AD- 4721312AE- 4721312AF	GRAND VOYAGER (III) (t.t.) Passo lungo VOYAGER (III) (t.t.) Passo lungo	rear RH	01-08	2680/2380
<b>07.2223</b>	4721028AG- 4721028AI- 4721028AJ	GRAND VOYAGER (III) (t.t.) Passo corto VOYAGER (III) (t.t.) Passo corto	rear RH	01-08	1145/740
<b>07.2224</b>	4721311AD- 4721311AE- 4721311AF	GRAND VOYAGER (III) (t.t.) Passo lungo VOYAGER (III) (t.t.) Passo lungo	rear LH	01-08	1355/1050
<b>07.2225</b>	4721029AJ- 721029AK- 4721029AL	GRAND VOYAGER (III) (t.t.) Passo corto VOYAGER (III) (t.t.) Passo corto	rear LH	01-08	1540/890
<b>07.2226</b>	4721310AC- 4721310AD- 4721310AE	GRAND VOYAGER (IV) (t.t.) VOYAGER (IV) (t.t.)	rear LH-RH	01-	1930/1670
<b>Citroen</b>					
<b>07.2227</b>	9812913880	C3 AirCross 1.2 Puretech, 1.6 BlueHDi	rear LH-RH	17-	1935/1105
<b>Fiat</b>					
<b>07.2228</b>	52056401- 52056402	500L, 500L Wagon (disc brake)	rear LH-RH	17-	1830/1570
<b>07.2229</b>	52056403	500L, 500L Wagon (drum brake)	rear LH-RH	17-	1775/1455
<b>07.2230</b>	500334919	DAILY C (I) 35C14 3.0 Hpi, 35C17 3.0 Hpi 3300 mm	front	99-06	1595/920
<b>07.2231</b>	500334918	DAILY C (I) t.t. 3000 mm	front	99-06	
<b>07.2232</b>	504160483	DAILY C (II) 35C10/11/12/13/15 2.3 Hpi 3000 mm DAILY S (II) 35S12 2.3 Hpi 3000 mm DAILY C (III) 35C11/13 2.3 Turbo DAILY C (III) 35C15/17/21 3.0 Turbo 3000 m	front	06- 06- 11-	1550/710
<b>07.2233</b>	504160484	DAILY C (II) 35C14 3.0 CNG, 35C15/18 3.0 Hpi 3300 mm DAILY C (III) 35C14 3.0 Natural Power, 35C15 3.0 3300 mm	front	06- 11-	1890/1245
<b>07.2234</b>	504160485	DAILY C (II) 35C14/C15/C17/C18 3.0 3450 mm	front	09-	2030/1245
<b>07.2235</b>	500334911	DAILY S (I) t.t. 3000 mm	front	99-06	
<b>07.2236</b>	504160478	DAILY S (II) t.t. 3000 mm	front	06-	1480/710

PIMAX REF.	OEM	APPLICATION		YEAR	↔
<b>07.2237</b>	504160479	DAILY S (II) t.t. 3300 mm	front	06-	
<b>Ford</b>					
<b>07.2238</b>	2221693	TOURNEO CUSTOM 2.0/2.2 TDCi Passo corto TRANSIT CUSTOM 2.0/2.2 TDCi Passo corto	rear RH	-16 16-	1060/680
<b>07.2239</b>	1830522- BK212A809CF	TOURNEO CUSTOM 2.0/2.2 TDCi Passo corto s.s. TRANSIT CUSTOM 2.0/2.2 TDCi Passo corto	rear LH	12-16 12-	1375/1165
<b>07.2240</b>	2221705	TOURNEO CUSTOM 2.0/2.2 TDCi Passo lungo s.s. TRANSIT CUSTOM 2.0/2.2 TDCi Passo lungo	rear LH	5/16- 10/16 15-	1505/1285
<b>07.2241</b>	2162782	TOURNEO CUSTOM 2.0/2.2 TDCi Passo lungo s.s. TRANSIT CUSTOM 2.0/2.2 TDCi Passo lungo	rear LH	-5/16 -5/16	1545/1330
<b>07.2242</b>	1884942	TRANSIT (VI) 2.2 TDCi Ruote singole	rear LH	14-	1570/1355
<b>07.2243</b>	2221708	TRANSIT CUSTOM 2.0/2.2 TDCi Passo corto	rear LH	5/16-	1355/1135
<b>07.2244</b>	1830745	TRANSIT CUSTOM 2.2 TDCi Passo corto	rear LH	12-	1375/1165
<b>07.2245</b>	1857405- 1883195- 2175769- DV612A603CD- DV6Z2A603C	TOURNEO CONNECT (II) 1.0 EcoBoost Passo lungo TOURNEO CONNECT (II) 1.6, 1.6 TDCi Passo lungo TRANSIT CONNECT (II) 1.0 EcoBoost Passo lungo TRANSIT CONNECT (II) 1.6 TDCi Passo lungo	rear LH-RH	13-	2285/2155 - 2325/2205
<b>07.2246</b>	1857404- 2024481- DV612A603BC	TOURNEO CONNECT (II) 1.0 EcoBoost Passo corto TOURNEO CONNECT (II) 1.6, 1.6 TDCi Passo corto TRANSIT CONNECT (II) 1.0 EcoBoost Passo corto TRANSIT CONNECT (II) 1.6 TDCi Passo corto	rear LH-RH	13-	1885/1760 - 1950/1825
<b>07.2247</b>	2221696	TOURNEO CUSTOM 2.0/2.2 TDCi Passo lungo TRANSIT CUSTOM 2.0/2.2 TDCi Passo lungo	rear RH	5/16- 10/16 15-	1295/1080
<b>07.2248</b>	2221691	TOURNEO CUSTOM 2.0/2.2 TDCi Passo lungo TRANSIT CUSTOM 2.0/2.2 TDCi Passo lungo	rear RH	12-16 12-16	1335/1120
<b>07.2249</b>	5065651	ECOSPORT 1.0 EcoBoost, 1.5 TDCi, 1.5 Ti-VCT KA+ 1.2 Ti-VCT	front	13- 16-	310
<b>Hyundai</b>					
<b>07.2250</b>	597702S250	iX35 1.6 GDi, 1.7 CRDi, 2.0 CRDi VGT, 2.0 Gdi	rear RH	13-	1720/1490
<b>07.2251</b>	597602S250	iX35 1.6 GDi, 1.7 CRDi, 2.0 CRDi VGT, 2.0 Gdi	rear LH	13-	1720/1490
<b>07.2252</b>	597702Y500	iX35 2.0 CRDi VGT, 2.0 GDi (4x4mod.)	rear RH	09-	1785/1505
<b>07.2253</b>	597602Y500	iX35 2.0 CRDi VGT, 2.0 GDi (4x4mod.)	rear LH	09-	1785/1505
<b>07.2254</b>	597704W100	iX35 Fuel Cell	rear RH	13-	1655/1415
<b>07.2255</b>	597604W100	iX35 Fuel Cell	rear LH	13-	1640/1400
<b>07.2256</b>	597702B000	SANTA FE' (II) 2.2 CRDi, 2.7 SANTA FE' (III) 2.0 CRDi, 2.2 CRDi, 2.4 CVVT	rear RH	06-09 09-	1815/1610
<b>07.2257</b>	597701G000	ACCENT (III) 1.4, 1.5 CRDi, 1.6 senza ABS	rear RH	05-07	1605/1345
<b>07.2258</b>	597601G000	ACCENT (III) 1.4, 1.5 CRDi, 1.6 senza ABS	rear LH	05-07	1605/1345
<b>07.2259</b>	597701G010	ACCENT (III) 1.4, 1.5 CRDi, 1.6 (drum brake)	rear RH	07-	1605/1345
<b>07.2260</b>	597601G010	ACCENT (III) 1.4, 1.5 CRDi, 1.6 (drum brake)	rear LH	07-	1605/1345
<b>07.2261</b>	597701G310	ACCENT (III) 1.4, 1.5 CRDi, 1.6 (disc brake)	rear RH	07-	1590/1340
<b>07.2262</b>	597601G310	ACCENT (III) 1.4, 1.5 CRDi, 1.6 (disc brake)	rear LH	07-	1590/1335
<b>07.2263</b>	597602B600- 597602B600DS	SANTA FE' (II) 4x4mod. SANTA FE' (III) 2.2 CRDi, 2.4 CVVT	rear LH	06- 09-	1675/1470
<b>07.2264</b>	597702B550- 597702B550DS	SANTA FE' (II) 4x4mod. Cambio Automatico	rear RH	06-	1965/1760

PIMAX REF.	OEM	APPLICATION		YEAR	↔
<b>Jeep</b>					
<b>07.0265</b>	52128072- 52128072AB- 52128072AD	CHEROKEE (I) 2.5 (t.t.) CHEROKEE (II) 2.5, 4.0 Sport	rear RH	97-01	1810/1605
<b>07.0266</b>	52128073	CHEROKEE (I) 2.5 (t.t.) CHEROKEE (II) 2.5, 4.0 Sport	rear LH	97-01	890/690
<b>07.0267</b>	52128164- 52128164AB	CHEROKEE (II) 2.5, 2.5 TD, 4.0 Sport	front	99-01	735/590
<b>Kia</b>					
<b>07.2268</b>	0K30A44150C- 0K30A44150D	RIO (I) 1.3, 1.5 Berlina/SW	front	00-05	220
<b>07.2257</b>	597701G000	RIO (II) 1.4, 1.5 CRDi, 1.6 CVVT senza ABS	rear RH	05-07	1605/1345
<b>07.2258</b>	597601G000	RIO (II) 1.4, 1.5 CRDi, 1.6 CVVT senza ABS	rear LH	05-07	1605/1345
<b>07.2259</b>	597701G010	RIO (II) 1.4, 1.5 CRDi, 1.6 CVVT	rear RH	07-	1605/1345
<b>07.2260</b>	597601G010	RIO (II) 1.4, 1.5 CRDi, 1.6 CVVT	rear LH	07-	1605/1345
<b>07.2273</b>	0K08A44150- 0K08A44150A- 0K08A44150B	SPORTAGE (I) 2.0 (t.t.)	front	96-03	400
<b>07.2274</b>	0K01244420A- 0K01244420B	SPORTAGE (I) 2.0 (t.t.) SPORTAGE (I) 2.0 Fuoristrada 3porte	rear LH	99-03	1225/945
<b>07.2275</b>	0K01244410- 0K01244410A	SPORTAGE (I) 2.0 Fuoristrada 3porte	rear RH	99-03	1455/1175
<b>07.2276</b>	597701F500	SPORTAGE (II) 2.0 CRDi/CVVT, 2.7	rear RH	04-10	1890/1655
<b>07.2277</b>	597601F500	SPORTAGE (II) 2.0 CRDi/CVVT, 2.7	rear LH	04-10	1840/1605
<b>07.2252</b>	597702Y500	SPORTAGE (III) 2.0 CRDi/CWT	rear RH	10-	1785/1505
<b>07.2253</b>	597602Y500	SPORTAGE (III) 2.0 CRDi/CWT	rear LH	10-	1785/1505
<b>Mercedes-Benz</b>					
<b>07.2280</b>	A2304200285	Classe SL «R230» Cabrio (t.t.)	front	05-	2140/1590
<b>07.2281</b>	A2304200485	Classe SL «R230» Cabrio (t.t.)	rear LH	05-	1180/970
<b>07.2282</b>	A2304200585	Classe SL «R230» Cabrio (t.t.)	rear RH	05-	1160/950
<b>07.2283</b>	A4634205085	Classe G «W463» G270 2.7 Cdi	rear RH	01-03	2375/2075
<b>07.2284</b>	A4634205185	Classe G «W463» G270 2.7 Cdi	rear LH	01-03	2230/1930
<b>07.2285</b>	A2044201785- A2044202685	Classe GLK «X204» Suv	rear LH-RH	08-	745/605
<b>Opel</b>					
<b>07.2286</b>	3642569	CROSSLAND X 1.2, 1.2 LPG, 1.6 CDTi	rear LH-RH	17-	1935/1100
<b>Peugeot</b>					
<b>07.2287</b>	474675- 9801531080	3008 2.0 HDi Hybrid4 4x4 Multispace	rear LH-RH	11-13	905/750
<b>Seat</b>					
<b>07.2288</b>	2Q0609721R	ARONA (t.t.) (disc brake) IBIZA (VI) «KJ1» (t.t.) (disc brake)	rear LH-RH	17-	1765/575
<b>07.2289</b>	1S0609721E- 1S0609721G	MII 1.0 EcoFuel	rear LH-RH	12-	1520/825
<b>Skoda</b>					
<b>07.2289</b>	1S0609721E- 1S0609721G	CITIGO 1.0 CNG	rear LH-RH	12-	1520/825
<b>Subaru</b>					
<b>07.2290</b>	26051FA120	IMPREZA (I) SW 1.6	rear RH	98-00	1590/1310
<b>07.2291</b>	26051FA130	IMPREZA (I) SW 1.6 IMPREZA (II) SW 1.6, 2.0	rear LH rear LH-RH	98-00 00-05	1610/1335

PIMAX REF.	OEM	APPLICATION		YEAR	↔
<b>07.2292</b>	26051FE060	IMPREZA (III) 1.5 R	rear RH	06-07	1565/1320
<b>07.2293</b>	26051FE070	IMPREZA (III) 1.5 R	rear LH	06-07	1585/1340
<b>07.2294</b>	26051SA040	FORESTER (II) 2.0, 2.0 Turbo IMPREZA (III) SW 2.0 R, 2.0 Turbo WRX	front	02-05 05-	250
<b>Toyota</b>					
<b>07.2295</b>	4642052330	VERSO-S 1.3 VVTi, 1.4 D4-D (drum brake)	rear RH	10-	1700/1475
<b>07.2296</b>	4643052250	VERSO-S 1.3 VVTi, 1.4 D4-D (drum brake)	rear LH	10-	1655/1430
<b>Volkswagen</b>					
<b>07.2297</b>	5C0609721J	NEW BEETLE (III) 2.0 Tsi	rear RH	4/11- 12/11	1485/825
<b>07.2298</b>	5C0609721AD	NEW BEETLE (III) 1.2 TSi, 1.4 TSi, 2.5 Tsi	rear RH	7/11- 12/11	1490/805
<b>07.2288</b>	2Q0609721R	POLO (VII) (t.t.) (disc brake)	rear LH-RH	17-	1765/575
<b>07.2289</b>	1S0609721E- 1S0609721G	UP 1.0 BlueMotion	rear LH-RH	12-16	1520/825

## Electric Park Brake Cables - Cables de Frein Electriques

PIMAX REF.	OEM	APPLICATION		YEAR	↔
<b>BMW</b>					
<b>07.2299E</b>	34436785429	Serie 5 «F07» GT (t.t.)	rear RH	09-	850/695
<b>07.2300E</b>	34436785428	Serie 5 «F07» GT (t.t.)	rear LH	09-	930/700
<b>07.2301E</b>	34436785430- 34436797372	Serie 7 «F01», «F02» (t.t.)	rear RH	08-	900/745
<b>07.2302E</b>	34436785427- 34436797371	Serie 7 «F01», «F02» (t.t.)	rear LH	08-	1000/775
<b>07.2303E</b>	34436772103	X5 «E70» X6 «E71»	rear LH	08-10	965/715
<b>07.2304E</b>	34436772104- 34436870192	X5 «E70», «F15» (t.t.) X6 «E71», «F16» (t.t.)	rear RH	06- 08-	905/710
<b>07.2305E</b>	34436857852- 34436870191	X5 «F15» (t.t.) X6 «F16» (t.t.)	rear LH	06- 08-	970/710
<b>Land Rover</b>					
<b>07.2306E</b>	SPB500180	RANGE ROVER (III) 3.6 TDV8 Vogue (4x4mod.) da tel. 7A000001	rear RH	06-09	900/720
<b>07.2307E</b>	SPB500190	RANGE ROVER (III) 3.6 TDV8 Vogue (4x4mod.) da tel. 7A000001	rear LH	06-09	815/715
<b>07.2306E</b>	SPB500180	RANGE ROVER (III) 3.6 TDV8, 4.4 TD, 5.0 (4x4mod)	rear RH	09-12	900/720
<b>07.2307E</b>	SPB500190	RANGE ROVER (III) 3.6 TDV8, 4.4 TD, 5.0 (4x4mod)	rear LH	09-12	815/715
<b>Mercedes-Benz</b>					
<b>07.2310E</b>	A2214201385	Classe S «W221» Berlina	rear LH	05-09	455/355
<b>07.2311E</b>	A2214201285	Classe S «W221» Berlina	rear RH	05-09	1050/890
<b>Opel</b>					
<b>07.2312E</b>	13441133- 522065-522073- 522089-522134	ASTRA «J» Berlina 5porte (t.t.)	rear LH-RH	09-	745/590 1915/1005 /590
<b>07.2313E</b>	13441132- 522096-522133	ASTRA «J» GTC 3porte (t.t.)	rear LH-RH	10-	765/615 1930/1005 /615

PIMAX REF.	OEM	APPLICATION		YEAR	↔
<b>07.2314E</b>	23227763- 522050-522084- 522095-522127- 522158	INSIGNIA Berlina/SW (t.t.)	rear LH-RH	08-	775/640 2160/1315 /640
<b>07.2315E</b>	20918016- 22821394- 22944244- 23227765- 522083-522094- 522126-522159	INSIGNIA Berlina/SW (t.t.) 4x4 mod.	rear LH-RH	12-	777/640 2210/1355 /640
<b>07.2316E</b>	13455236- 13478343- 522146-522157	MERIVA «B» (t.t.)	rear LH-RH	10-	975/520 1960/1085 /520
<b>Peugeot</b>					
<b>07.2317E</b>	474680	3008 (I) 1.6, 2.0 (t.t.) Multispace <i>fino a OPR 12183</i> [KIT 2 pezzi]	front	09-	1640/1465 - 830/665

# NOTE



A series of horizontal dotted lines for writing notes.



A series of horizontal dotted lines spanning the width of the page, providing a guide for handwriting practice.

---

**PIMAX S.r.l.**

---

Piazza Santa Rita, 8  
10136 - Turin (ITALY) Tel. +39 011 591292

**e-mail [info@pimax.it](mailto:info@pimax.it)  
[www.pimax.it](http://www.pimax.it)**



**TRUCK AUTO COMMERCIAL  
VINTAGE CAR COCHE VEICOLO  
VÉHICULE COMMERCIAL TRUCK  
AUTO COMMERCIAL VEHÍCLE CAMIÓN VINTAGE CAR  
COCHE VEICOLO D'EPOCA CAMION VÉHICULE  
COMMERCIAL TRUCK AUTO COMMERCIAL VEHÍCLE  
CAMIÓN VINTAGE CAR COCHE VEICOLO D'EPOCA**